

## ***H590 User Manual***

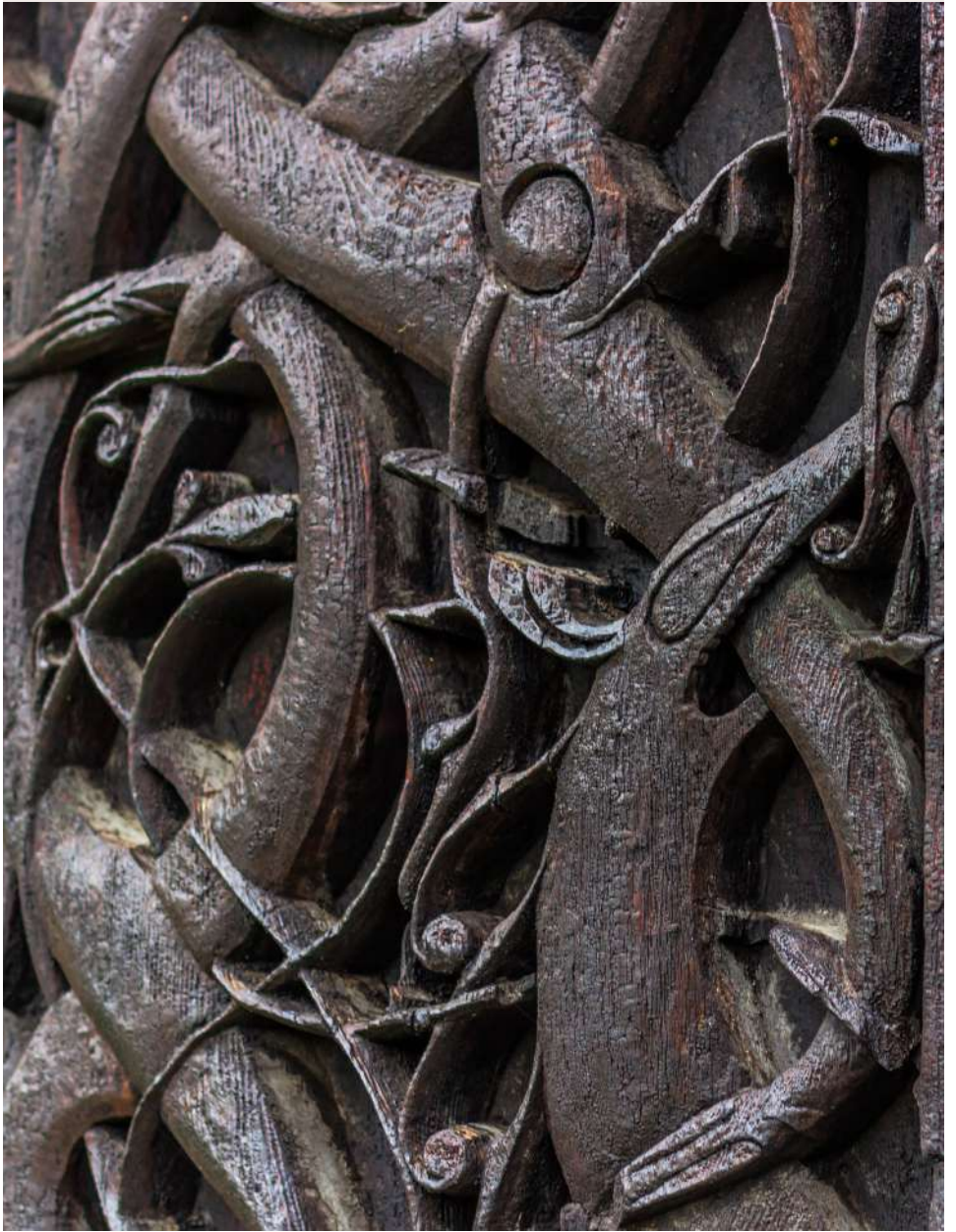



## Index

A word from Bent	4
What's in the box	5
Quickstart	6
General Use	10
Connections	11
USB	12
Network Configuration	13
Using AirPlay	14
Remote Control	16
Special Functions	17
DAC Loop, General Information	18
Additional Information	19



Congratulations on your new Hegel H590. All Hegel products are based on a simple philosophy: Add as little as possible. We work to keep the music signal as close to the original as possible. We are always looking for ways to lower distortion and lower noise so that the music is reproduced as close to the original as possible and is limited only by the quality of the recording. Our aim is to give you the best possible music experience. Our minimalist Scandinavian design is styled to fit in with any interior. Our products are easy to operate and are manufactured according to the best quality principles.

“Hegel H590 is our brand new reference integrated amplifier and sets a new standard in our lineup of integrated amps. We have taken digital technology from our reference products, added a brand new usb solution, and given it more power than any of our other integrated products. All that power and versatility is set in the fresh new Hegel appearance. H590 reference is everything that our partners and customers have asked for: a bigger and better Hegel integrated. So we gave them a beast that controls even the biggest of speakers in addition to more inputs, more advanced streaming and much better sound”

A handwritten signature in black ink, appearing to read 'Bent Holter', with a long, sweeping horizontal line extending to the right.

Bent Holter  
Founder Hegel Music System

## What's in the box

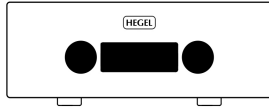

Amplifier

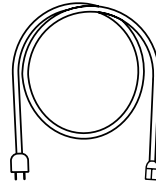

Power Cord

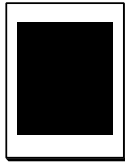

Accessory Box

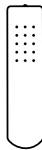

Remote Control

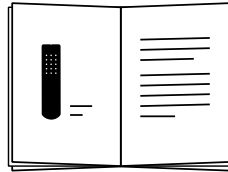

User Manual

# Quickstart

## 1. Connect your speakers

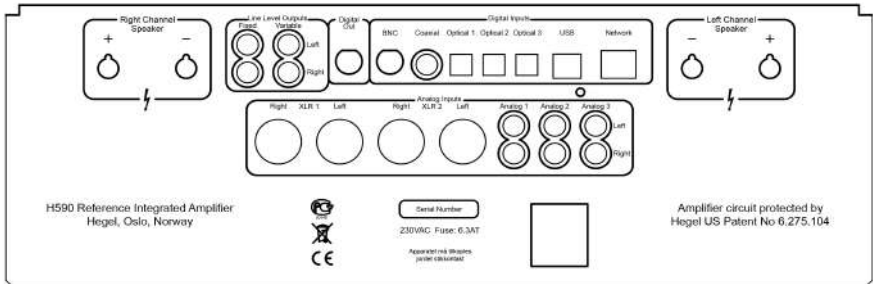

For the best audio experience the distance between the listener and each speaker should be the same.

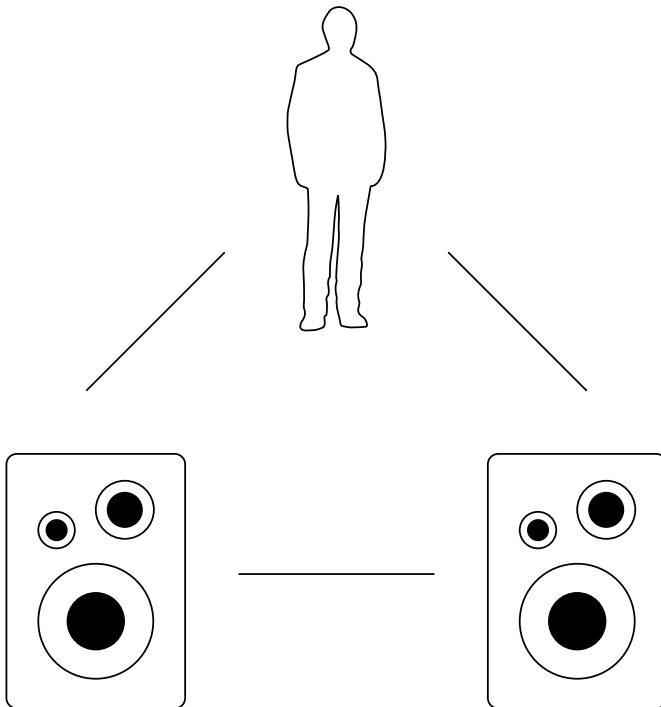

# Quickstart

## 2. Connect a source

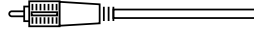
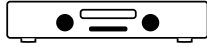

Unbalanced Analog

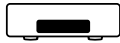

Balanced Analog

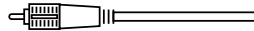
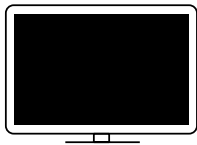

Coaxial Digital

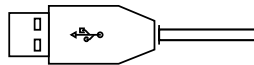

USB Computer

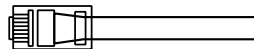
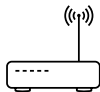

Network streaming

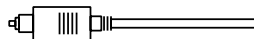

Optical Digital

## Quickstart

### 3. Connect the power cord

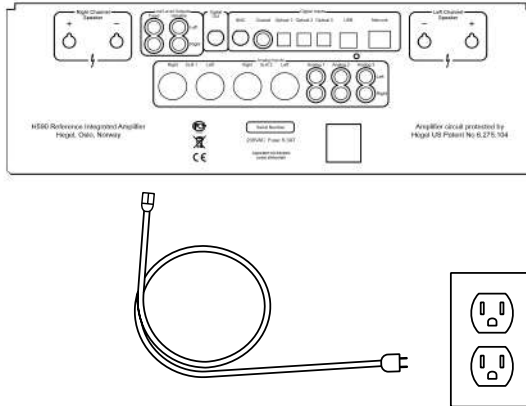

### 4. Turn on the amplifier

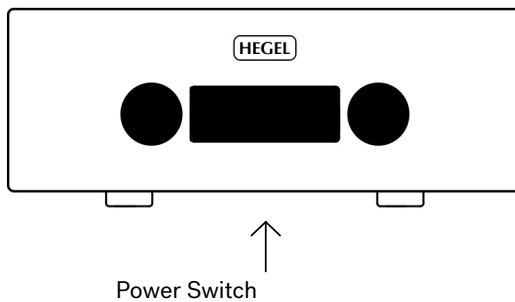





## General Use

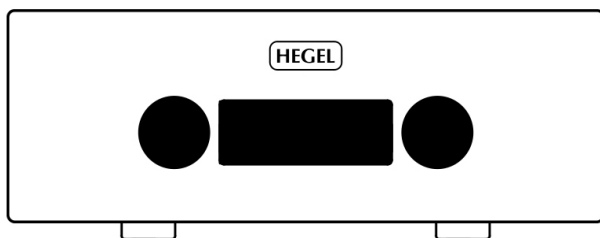

### On/Off

The H590 amplifier is switched on and off with the power button located on the underside of the amplifier, towards the front of the unit. When powered up, the H590 takes a few seconds to calibrate. During this time, the outputs are muted

**NOTE: When powering up, the outputs are muted and the right hand part of the display flashes for a few seconds indicating mute. This is normal, and is part of the start-up procedure.**

**NOTE: When the H590 has been switched off, wait 30 seconds before powering on again.**

### Display

The left side of the display shows the selected source input, while the volume value is shown on the right side of the display. A flashing volume value indicates the amplifier is in mute mode.

### Source Selector

The input source selector knob is on the left side of the front panel.

### Volume

The volume control knob is on the right side of the front panel. The volume level is indicated by a number between 0 and 99 on the right side of the display, with 0 being the mute level and 99 being max volume. The H590 powers up with a preset volume value. The volume level is adjusted by turning the volume knob clockwise or counter clockwise, or by using the Hegel remote control.

### Mute

Pressing the mute button on the Hegel remote control mutes the outputs on the amplifier. The volume number flashes to indicate that mute is on. Press the mute button, or adjust the volume level, to switch mute off.

### Status Indicators

The Hegel H590 will display the product status

✓ If it is connected to a network

✗ If there is a network problem

# Connections

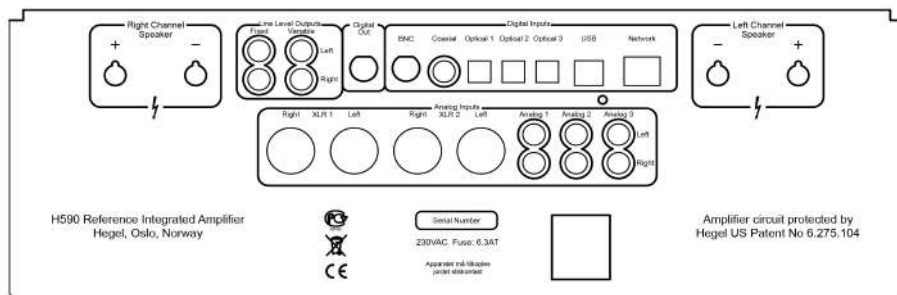

Always power the amplifier off before connecting input/output audio cables and the power cable.

## Right Channel Speaker

- Right outputs

## Line Level Outputs

- Fixed Line level (RCA)  
WARNING High level output.
- Variable Line Level (RCA)

## Digital Out(DAC loop)

- BNC: Output BNC

## Digital Input

- BNC: Input BNC
- Coaxial: Input Coaxial/RCA
- Optical1: Input TOSLINK/EIAJ Optical
- Optical2: Input TOSLINK/EIAJ Optical
- Optical3: Input TOSLINK/EIAJ Optical
- Computer USB input
- Home network connection (LAN - RJ45)

## Left Channel Speakers

- Left outputs

## Analog Inputs

- XLR1 (XLR): Standard balanced analog input (Pin 1 is Chassis Ground; Pin 2 is Positive Phase; Pin 3 is Negative Phase)
- XLR2 (XLR): Standard balanced analog input (Pin 1 is Chassis Ground; Pin 2 is Positive Phase; Pin 3 is Negative Phase)
- Analog 1(RCA): Standard analog input
- Analog 2(RCA): Standard analog input
- Analog 3(RCA): Standard analog input

## AC Power Connection

- AC Power connector with fuse holder: 230V/115V/100V AC depending on country.

## Home Theater

Most inputs on H590 can be used as a Home Theater input, see page 17.

## USB

The Hegel H590 has a plug and play USB DAC. Connect it to your PC or Mac and enjoy all your music.

When connected the amplifier will show up as Hegel H590 under the speaker settings in your operating system. If you have an older version of Windows you will need to instal a driver. Then "XMOS USB Audio" will be the H590 in the speaker settings.

There is no driver required for Linux, Mac OS, or Windows10. If you have an older version of Windows you can download a driver on our website. Go to [www.hegel.com/products/integrated/H590](http://www.hegel.com/products/integrated/H590) for driver download.

Resolution: Up to 384 kHz 32 bit

H590 supports DSD64,DSD128,DSD256 via DoP

### **MQA (Master Quality Authenticated)**

Hegel H590 includes MQA technology, which enables you to play back MQA audio files and streams, delivering the sound of the original master recording.

"MQA" or "MQA." indicates that the product is decoding and playing an MQA stream or file, and denotes provenance to ensure that the sound is identical to that of the source material. "MQA." indicates it is playing an MQA Studio file, which has either been approved in the studio by the artist/producer or has been verified by the copyright owner. "OFS" confirms that the product is receiving a decoded MQA stream or file. This delivers the final unfold of the MQA file and displays the original sample rate.

Hegel H590 supports up to MQA 8X (352.8kHz/384kHz)

NOTE: MQA is only available on the USB input

Visit [mqa.co.uk](http://mqa.co.uk) for more information.



## Network Configuration

The Hegel H590 has its own Network Configuration page to where you can change the name, the IP settings and update the firmware.

Find the name of the unit by pressing and holding "COMPUTER PLAY" (2) button. A menu appears and use "COMPUTER NEXT"(3) button to choose "Network". It will then display the name and IP address of your H590.

PC/Mac: Type in the IP in your browser and the Network Configuration page opens.

### Playing Files on a Network Device

The Hegel H590 can function as a Digital Media Renderer. This means that it can receive and play media files from a UPnP/DLNA compatible media player.

For details on how to set up your media player, please refer to the user manual supplied with the player.

Software Updates, more detailed info on the Network Configuration page, supported formats and much more are available on: [www.hegel.com/products/integrated/H590](http://www.hegel.com/products/integrated/H590)

## Using AirPlay

When using AirPlay on the Hegel H590, you can send the music stream from your AirPlay compatible device, to the amplifier. Start with connecting your Hegel H590 to your local network using Ethernet cable from network connection (LAN - RJ45) on the back of the amplifier, to your router.

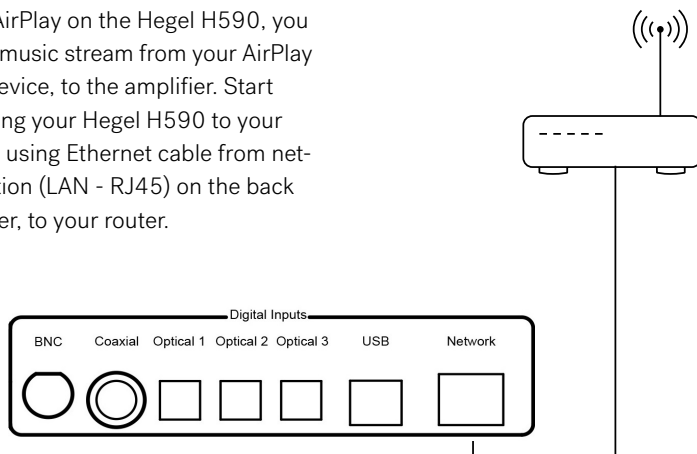

Make sure the Hegel H590 is connected to your local network.

When connected, the unit will set up to DHCP, and will automatically receive an IP-address and then integrate in your home network. All AirPlay compatible devices will now detect the Hegel H590 in their list of AirPlay speakers, it will be displayed as "H590", followed by a unique number.

To activate the AirPlay function on your AirPlay compatible device, you must first make sure the device is connected to the same network as the Hegel H590. For details on this please check the device manual. Then the AirPlay icon will be displayed and you can select the H590. You are now ready to send the music stream to your amplifier.

### Playing from iTunes on your Hegel H590.

Install iTunes 11, or later, on your Mac or Windows computer. Launch iTunes, press the AirPlay Logo, and select the H590. You can also play to more than one speaker at a time, select the AirPlay logo, then "multiple" and check of the speakers that you want to listen to. You can also adjust the volume on each individual speaker.

[WARNING: After selecting the H590 as the output, always remember to check the iTunes volume-setting before pressing play. The H590 will change its volume to the volume set in iTunes, when iTunes starts playing to the H590.](#)



## Remote Control - RC8

The Hegel H590 can be controlled with the included Hegel RC8 Remote Control. The RC8 controls other Hegel products, such as amplifiers and preamplifiers, and most Media players on your Mac/PC, avoiding the need for multiple remote control device

The remote control uses two standard 1.5-volt LR03 AAA batteries. To insert the batteries, use a crosshead (Phillips) screwdriver to gently remove the four screws on the underside of the remote control.

Insert the batteries with the correct polarity with + sign and - sign, as shown inside the battery holder. Be careful when inserting the batteries to not damage the battery holder. Replace the cover. Insert the screws by gently turning them by hand, to avoid damaging the threads in the remote control chassis.

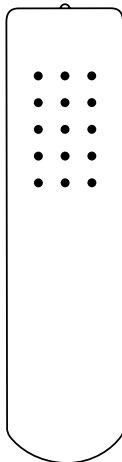

Do not tighten the screws too much, as this can damage the screws and the soft metal chassis of the remote control.

Caution: Do not drop the remote control on the floor, as this can damage its internal parts and the battery holder.

To avoid damage to the remote control by leakage from the batteries during transport and storage, the remote control is supplied without batteries from Hegel.

### Remote control buttons (starting top left)

1. Skip to previous track on most computers/media players
2. Play/Pause on most computers/media players
3. Skip to next track on most computers/media players
4. Input source selector button for Hegel DACs
5. ECO will put certain Hegel equipment in low power mode
6. Display on/off (hold for off)
7. Skip to previous track on Hegel CD-players
8. Play/Pause for Hegel CD-players
9. Skip to next track on Hegel CD-players
10. Switches up to next input on your Hegel amplifier
11. Stop/Eject for Hegel CD-players
12. Volume up for Hegel amplifiers
13. Switches down to previous input on your Hegel amplifier
14. Mute for Hegel amplifiers
15. Volume down for Hegel amplifiers



## Special Functions

### Display On/Off

The DISP button on the RC8 remote control may be used to turn the display of the H590 on or off. Hold the DISP button for more than 1 second to turn the display off. Press the button turn the display on.

### Home Theater or Standard Analog Input

Most inputs can be changed into a Home Theater input. This will set the Volume at a fixed high volume level. Use the RC8 remote to change the settings. Hold "COMPUTER PLAY"(2) until the setup menu appears. Use computer prev/next to navigate to "HT" and press "COMPUTER PLAY"(2) to select this submenu. Now use "COMPUTER NEXT"(3) to maneuver to the input you want to change into a fixed level input. Press "COMPUTER PLAY"(2) to toggle between a fixed level input or normal variable input. Now don't press anything for 15sec, and the H590 will return to normal mode.

[WARNING: Activating Home Theater sets the volume at a high fixed level. This may harm your speakers if a fixed level input is connected.](#)

### Set Power Up Volume

A user defined volume value may be used as the power-up volume. The current volume is set as the power-up volume by pressing and holding the DAC+ button while pressing Vol- on the RC8 remote control.

### Reset to Factory Default Settings

By pressing and holding the DAC+ button while pressing Mute on the RC8, the H590 will be reset to factory settings. This will clear all user defined settings, including IP settings, and reinitialize the H590.

### Max Volume

A user defined volume value may be used as the max volume.

The current volume is set as the max volume by pressing and holding the DAC+ button while pressing Vol+ on the RC8 remote control. To reset, put to max volume, press and holding the DAC+ button while pressing Vol+ on the RC8 remote control.

### Using the USB Connection:

When you connect H590 to a computer with a USB cable (not included), the H590 will automatically install itself as a USB soundcard on all newer versions of Windows and Mac OS X, and most newer versions of Linux. For older versions of windows see [www.hegel.com/products/integrated/H590](http://www.hegel.com/products/integrated/H590) for a driver to match your Operating System

### DAC-Loop

This function makes it possible to upgrade the digital inputs of the H590 with an external high-end DAC. This is done by connecting the re-clocked coaxial digital output of the H590 to the external DAC. The output of the external DAC will need to be connected to the XLR1 input of the H590.

Use the RC8 remote to change the settings. Hold "COMPUTER PLAY"(2) until the setup menu appears. Use computer prev/next to navigate to "DAC-LOOP" and press "COMPUTER PLAY"(2) to select this submenu. Press "COMPUTER PLAY"(2) to turn on/off. Now don't press anything for 15sec, and the H590 will return to normal mode.

## General Information

### Technical Specifications

#### H590 Integrated Amplifier

Power output	2*301W in 8 ohms Dual Mono
Minimum load	2 ohms
Analog Inputs	2*balanced (XLR) 3*unbalanced (RCA)
Digital Outputs	1*coaxial (BNC) S/PDIF
Digital Inputs	1*coaxial (BNC) S/PDIF 1*coaxial (RCA) S/PDIF 3*optical S/PDIF 1*USB 1*Network
Line level Output	1*unbalanced fixed(RCA), 1*unbalanced variable(RCA)
MQA supported inputs	USB only
Frequency response	5Hz-100kHz
Signal-to-noise ratio	More than 100dB
Crosstalk	Less than -100dB
Distortion	Less than 0.005% @ 50W 8 Ohms 1kHz
Intermodulation	Less than 0.01% (19kHz + 20kHz)
Damping factor	More than 4000 (main power output stage)
Dimensions	17,1cm x 43cm x 44,5cm (HxWxD), 22kg unit weight. 6,74" x 16,93" x 17,52" (HxWxD), 48,51 lbs unit weight.

### Transport and Shipment

If you are packing the amplifier for shipping, please follow these instructions to avoid damaging the unit: Be careful not to hold the volume- and source-knobs when lifting the amplifier. Put the bag around the amplifier. Make sure the bottom shock absorber is placed at the bottom of the original cardboard box. Place the amplifier into the shock absorber. Place the top shock absorber on top of the amplifier.

### Use and Placement

The Hegel H590 should be placed on a flat, hard surface for proper cooling. The amplifier performs best after being switched on for about 1 hour for heating up. A certain space is required for air circulation above and below the amplifier. The amplifier must never be placed on a carpet or similar surface that obstructs air circulation through the unit. Nor must it be covered while in use or placed on a narrow shelf or in another confined space.

The amplifier will automatically switch itself off if overheated, "HOT!" will be displayed. When it cools down the relays kick in and the amp set the volume to 0.

### Cleaning

Fingerprints or stains on the front panel or top cover can be removed with a cloth moistened with warm water or a mild detergent suitable for cleaning mirrors and windows.

## Additional Information

### Warning

Hegel products should only be opened or serviced by certified technicians. The devices contain electronic components that may cause severe electric shock. Work performed on Hegel products by unqualified personnel may cause serious damage or personal injury.

Opening of the product by non-authorized personnel will void the guarantee.

The products must not be exposed to rain or moisture.

### Warranty

All Hegel products come with a 2-year warranty against defective materials and workmanship.

In case you would need any assistance with your Hegel product please find your nearest dealer or distributor by looking at the Hegel web site <http://www.hegel.com>. If you experience any problems locating your dealer or distributor please contact [info@hegel.com](mailto:info@hegel.com)

### More Information

For more information, please visit [www.hegel.com/products/integrated/H590](http://www.hegel.com/products/integrated/H590)



AirPlay works with iPhone, iPad, and iPod touch, or Mac and PC with iTunes.

Use of the Works with Apple badge means that an accessory has been designed to work specifically with the technology identified in the badge and has been certified by the developer to meet Apple performance standards.

Apple, iPad and iPhone are trademarks of Apple Inc., registered in the U.S. and other countries. The trademark "iPhone" is used in Japan with a license from Aiphone K.K.



The MQA logo is a trade mark of MQA Limited. © MQA Limited 2018



