



AVENTAGE

AV Pre-Amplifier

CX-A5200

Owner's Manual

musicCast

-
- This unit is a product for enjoying video and music at home.
 - This manual explains preparations and operations for everyday users of the unit.
 - Read the supplied booklet “Quick Start Guide” before using the unit.

CONTENTS

Introduction 5

Accessories..... 5

About this book 5

About remote control 6

Batteries 6

Operating range of the remote control..... 6

FEATURES 7

What you can do with the unit..... 7

AV CONTROLLER..... 12

MusicCast CONTROLLER..... 12

Part names and functions 13

Front panel 13

Front display (indicators) 15

Rear panel..... 16

Remote control 18

PREPARATIONS 19

General setup procedure 19

1 Placing speakers 20

Basic speaker configuration 21

Input/output jacks and cables 28

2 Connecting the power amplifier and subwoofers 30

Connecting a power amplifier 30

Connecting subwoofers..... 31

3 Connecting a TV and playback devices 33

Connecting a TV 33

Connecting video devices (such as BD/DVD players) 34

Connecting audio devices (such as CD players) 36

Connecting to the jacks on the front panel 37

4 Connecting the radio antennas..... 38

FM/AM antennas (except Australia, U.K., Europe, Middle East and Russia models) 38

DAB/FM antenna (Australia, U.K., Europe, Middle East and Russia models only) 38

5 Connecting a network cable or preparing the wireless antenna 39

Connecting the network cable 39

Preparing the wireless antenna 39

6 Connecting other devices..... 40

Connecting a device with analog multichannel output 40

Connecting a device compatible with the trigger function 40

7 Connecting the power cable 41

8 Selecting an on-screen menu language 42

9 Configuring the necessary speaker settings..... 43

10 Optimizing the speaker settings automatically (YPAO) 44

Multi Measure 46

Angle/Height Measure 47

Measuring at one listening position (single measure) 47

Measuring at multiple listening positions (multi measure) 50

Checking the measurement results 53

Reloading the previous YPAO adjustments 53

Error messages 54

Warning messages 55

11 Connecting to a network device wirelessly 56

Connecting with a wireless router (access point) 56

Connecting the unit to a wireless network..... 57

12 Connecting to the MusicCast network 62

MusicCast CONTROLLER 62

Adding the unit to the MusicCast network 62

PLAYBACK

63

Basic playback procedure	63
Selecting an HDMI output jack	63
Selecting the input source and favorite settings with one touch (SCENE)	64
Registering a scene	64
Selecting the sound mode	65
Playing back with surround effects optimized for the scene (SURROUND:AI).....	66
Enjoying stereoscopic sound fields (CINEMA DSP HD ³)	66
Enjoying unprocessed playback.....	70
Enjoying pure high fidelity sound (Pure Direct).....	71
Playing back digitally compressed formats (such as MP3, etc.) with enriched sound (Compressed Music Enhancer)	71
Listening to FM/AM radio (except Australia, U.K., Europe, Middle East and Russia models)	72
Setting the frequency steps.....	72
Selecting a frequency for reception.....	73
Registering favorite radio stations (presets)	73
Listening to DAB radio (Australia, U.K., Europe, Middle East and Russia models only)	75
Preparing the DAB tuning	76
Selecting a DAB radio station for reception.....	76
Registering favorite DAB radio stations (presets).....	77
Displaying the DAB information	78
Checking reception strength of each DAB channel label	79
Listening to FM radio (Australia, U.K., Europe, Middle East and Russia models only)	81
Selecting a frequency for reception	81
Registering favorite FM radio stations (presets).....	82
Radio Data System tuning	84
Playing back music via Bluetooth	85
Playing back Bluetooth device music on the unit	85
Playing back music stored on a USB storage device	86
Connecting a USB storage device	86
Playback of USB storage device contents	87

Playing back music stored on media servers (PCs/NAS)	90
Media sharing setup	90
Playback of PC music contents	91
Listening to Internet radio	94
Playback of Internet radio.....	94
Registering favorite Internet radio stations (Favorites)	96
Playing back iTunes/iPod music with AirPlay	97
Playback of iTunes/iPod music contents	97
Playing back videos/audio in multiple rooms (multi-zone)	99
Multi-zone configuration examples	99
Preparing the multi zone system	100
Controlling Zone2, Zone3 or Zone4	103
Registering favorite items (shortcut)	105
Registering an item.....	105
Recalling a registered item.....	105
Viewing the current status	106
Switching information on the front display	106
Viewing the status information on the TV	107
Configuring playback settings for different playback sources (Option menu)	108
Option menu items.....	109

Configuring various functions (Setup menu)	115
Setup menu items	116
Speaker	121
Sound	125
Scene	131
Video/HDMI	132
Network	135
Bluetooth	138
Multi Zone	139
System	141
Configuring the system settings (ADVANCED SETUP menu)	147
ADVANCED SETUP menu items	148
Turning on/off the remote control sensor (REMOTE SENSOR)	148
Selecting the remote control ID (REMOTE ID)	148
Changing the FM/AM tuning frequency setting (TUNER FRQ STEP)	148
Switching the video signal type (TV FORMAT)	149
Removing the limitation on HDMI video output (MONITOR CHECK)	149
Selecting the HDMI 4K signal format (4K MODE)	149
Switching the DTS format notification setting (DTS MODE)	150
Backing up/recovering the settings (BACKUP/RESTORE)	150
Restoring the default settings (INITIALIZE)	150
Updating the firmware (FIRM. UPDATE)	151
Checking the firmware version (VERSION)	151
Updating the unit's firmware via the network	152
Updating the unit's firmware	152

Frequently asked questions	153
Troubleshooting	154
First, check the following:	154
Power, system and remote control	154
Audio	155
Video	157
FM/AM radio (AM radio feature is not available for the Australia, U.K., Europe, Middle East and Russia models)	158
DAB radio (Australia, U.K., Europe, Middle East and Russia models only)	158
Bluetooth	159
USB and network	160
Error indications on the front display	162
Glossary	163
Audio information (audio decoding format)	163
Audio Information (Others)	165
HDMI and video information	165
Network information	166
Yamaha technologies	166
Supported devices and file formats	167
Supported devices	167
File formats	167
Video signal flow	168
Video conversion table	168
Multi-zone output	169
Information on HDMI	169
HDMI Control	169
Audio Return Channel (ARC)	171
HDMI signal compatibility	171
Trademarks	172
Specifications	173

Introduction

Accessories

Check that the following accessories are supplied with the product.

- AM antenna
(except Australia, U.K., Europe, Middle East and Russia models)



- FM antenna
(except Australia, U.K., Europe, Middle East and Russia models)

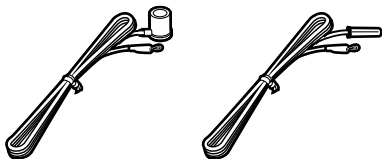

- DAB/FM antenna
(Australia, U.K., Europe, Middle East and Russia models only)

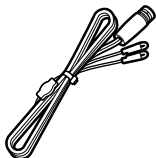

- YPAO microphone

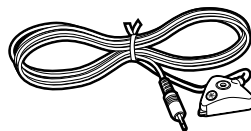

- Microphone base Pole

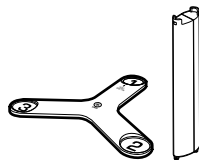

- Power cable
- Remote control
- Batteries (AAA, LR03, UM-4) (x2)
- Quick Start Guide

* (Except Australia, U.K., Europe, Middle East and Russia models)

One of the above FM antennas is supplied depending on the region of purchase.

* The microphone base and pole are used for angle/height measurement during YPAO.

* The supplied power cable varies depending on the region of purchase.

About this book

The illustrations of the main unit used in this manual are of the CX-A5200 (U.S.A. model), unless otherwise specified.

In this manual, illustrations of English menu screens are used as examples.

Some features are not available in certain regions.

Due to product improvements, specifications and appearance are subject to change without notice.

This manual explains operations using the supplied remote control.

This manual describes all the “iPod touch”, “iPhone” and “iPad” as the “iPod”. “iPod” refers to “iPod touch”, “iPhone” and “iPad”, unless otherwise specified.

Icons used in this manual



indicates precautions for use of the unit and its feature limitations.



indicates supplementary explanations for better use.

About remote control

This section explains how to use the supplied remote control.

Batteries

Insert the batteries the right way round.

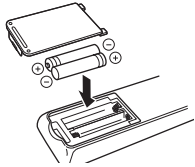

Operating range of the remote control

Point the remote control at the remote control sensor on the unit and remain within the operating range shown below.

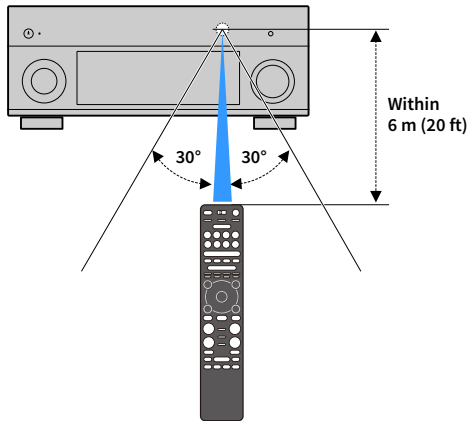

FEATURES

What you can do with the unit

The unit is equipped with the various useful features.

Connecting various devices (p.28)

A number of HDMI jacks and various input/output jacks on the unit allow you to connect video devices (such as BD/DVD players), audio devices (such as CD players), game consoles, camcorders, and other devices.

Playing back TV audio in surround sound with a single HDMI cable connection (Audio Return Channel: ARC) (p.33)

When using an ARC-compatible TV, you only need one HDMI cable to enable video output to the TV, audio input from the TV, and the transmission of HDMI Control signals.

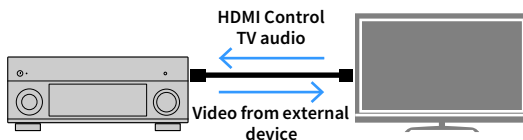

More advanced ENTERTAINMENT sound programs (p.67)

By processing front left and front right sound fields individually, the ENTERTAINMENT sound programs are further improved in acoustic positioning and sound transition. These programs allow you to enjoy clearer vocal and instrumental sounds, distinct narrations, and more dynamic sound effects.

Providing a realistic feel and surround effect optimized for the scene of the content (SURROUND:AI) (p.66)

The AI incorporated in the DSP analyzes the scene of the content and creates the optimal surround effect for it.

This AI instantaneously analyzes scenes by focusing on sound elements such as “dialogue”, “background music”, “ambient sounds” and “sound effects” as well as optimizes the surround effect in real time.

This creates a compelling sense of realism with expressive power beyond conventional sound field effects.

Various wireless connection methods (p.56)

The unit supports the Wi-Fi feature that allows the unit to connect to your wireless router (access point) without a network cable connection.

Home Audio Network with MusicCast (p.62)

The unit supports the MusicCast feature that allows you to link a MusicCast compatible device to another device in a different room and play them back simultaneously, or control all MusicCast compatible devices with the dedicated application “MusicCast CONTROLLER”.

Backlit remote control (p.18)

This unit’s backlit remote control provides excellent visibility, making it easy to use, even in a dark room.

The excitement of a concert hall and the powerful sense of being inside a movie - we all want to enjoy these experiences in our own living room. Yamaha has pursued the fulfillment of these desires for more than 30 years, and this fulfillment has now taken shape as the Yamaha AV receivers.

What is a sound field?

We perceive sound from a voice or an instrument not only as the sounds that are heard directly but also as the “reflected” or “reverberant” sound that has been reflected by the walls or ceiling of the building. The character of the reflected and reverberant sound is affected by the shape, size, and material of the building, and all of these sounds taken together are what give us the auditory sensation of being in that specific place.

This unique acoustical character of a specific space is what we call the “sound field”.

Conceptual diagram of a concert hall’s sound field

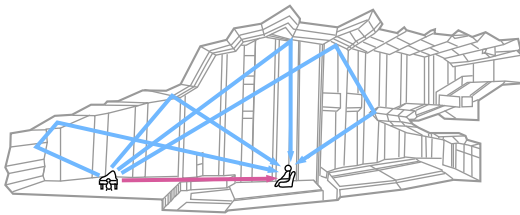

Conceptual diagram of a sound field created by the unit

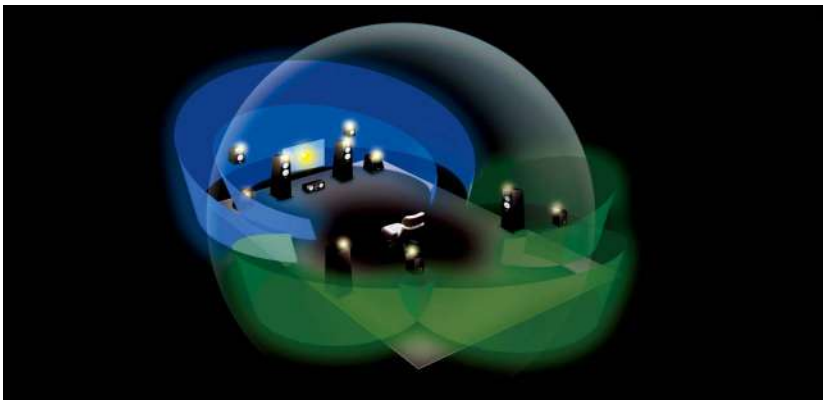

CINEMA DSP

Yamaha has accumulated a massive amount of acoustical data by analyzing the actual sound fields of concert halls and performance spaces around the world. “CINEMA DSP” allows this data to be applied to create sound fields. This unit contains a wide variety of sound programs using CINEMA DSP.

By selecting a sound program that is appropriate to the content of the playback source such as movies, music, or games, you can maximize the acoustical effectiveness of that specific content. (For example, a sound program designed for movies can give you the sensation of actually being in that scene.)

CINEMA DSP HD³

“CINEMA DSP HD³” is Yamaha’s flagship 3D sound field playback technology that takes full advantage of the massive amount of acoustic reflection data included in the sound field data. It delivers more than twice as much capability for generating acoustic reflections as conventional CINEMA DSP 3D, in addition to high-frequency playback capability, delivering an utterly natural and powerful spatial sound field.

Capability for reproducing reflections (when the sound program “Hall in Munich” is selected)

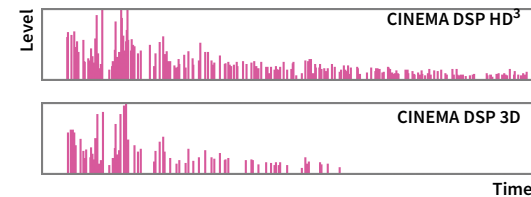

YPAO is Yamaha original automatic calibration system to optimizing your sound and surround environment by using microphone measurement. It can be create ideal listening environment for maximizing high sound quality contents playback by adjusting various speakers setting and the sound field automatically.

YPAO-R.S.C.

In typical home, the sound has problems such as a blurred low-frequency range or a smearing of the acoustical sound image caused by undesirable sound reflection from the walls or ceiling. “YPAO-R.S.C.” is technology that reduces only the unwanted reflections and produces the acoustic perfection for your listening environment.

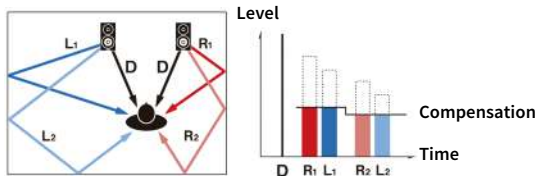

YPAO Volume

YPAO Volume automatically adjusts the high and low frequency levels at any volume level so that you hear natural sounds even at low volume.

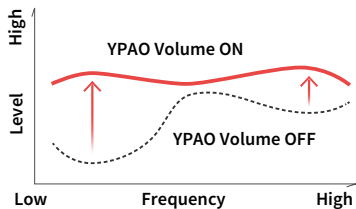

YPAO 3D measurement

The direction (angle) of front, surround and presence speakers, and the height of presence speakers as seen from the listening position is measured, and compensation is applied to maximize the 3D sound field effectiveness of the CINEMA DSP.

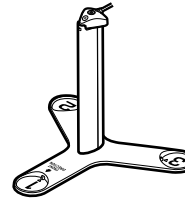

Unrivaled audio and video quality

You can enjoy unrivaled high-quality audio and videos with the unit.

High-resolution music enhancer

Hi-bit high-sampling extension up to 96 kHz / 24-bit can be applied to lossless 44.1/48 kHz content such as from a CD (2-channel PCM) or a FLAC file for further heightening of the musicality in the original content (p.111).

Before processing

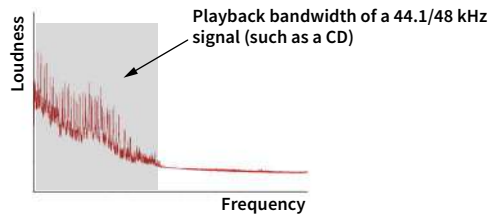

After processing

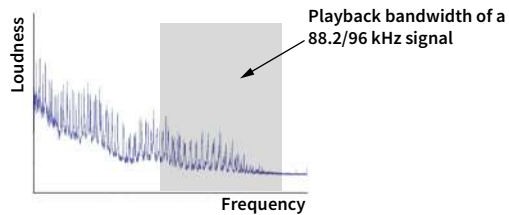

High-quality video processing

From low-quality digital video to BD (Blu-ray disc) images, any content can be played back as a high-quality image (p.132).

- Motion adaptive and edge adaptive deinterlacing
- Multi-cadence (including 3-2 pull-down) detection
- Up to 6 presets that can be applied separately to each input source

You can also apply fine touches such as detail enhancement and edge enhancement.

Expandable to meet diverse needs

The unit provides excellent expandability which is applicable to all uses.

The best expandability in Yamaha

You can enjoy the highest peak of CINEMA DSP - an 11.2-channel 3-dimensional sound field.

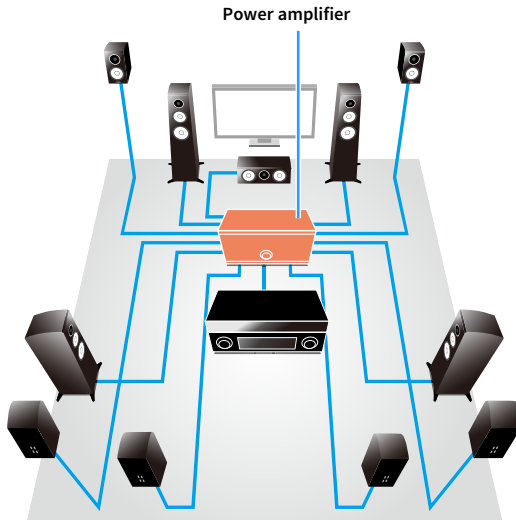

- Flexible connectivity (ready for balanced and unbalanced connections)
- High-quality audio transmission (XLR balanced pre-out)
- XLR balanced input jacks for connecting a high-end such as CD player

Multi-zone function

The multi-zone function (p.99) allows you to play back different input sources in the room where the unit is installed (main zone) and in other rooms (such as Zone2).

(The following shows examples of use.)

Enjoying music using speakers in another room

While enjoying multichannel playback in your living room, you can listen to music through the speakers of a different room.

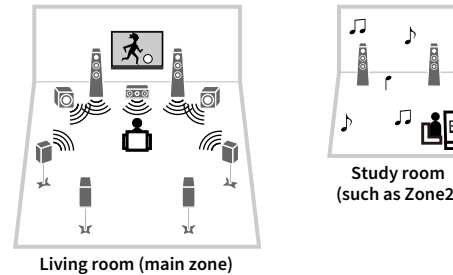

Enjoying videos using a TV in another room (HDMI connection)

While enjoying multichannel playback in your living room, you can enjoy videos and music being input via HDMI on a TV in a different room.

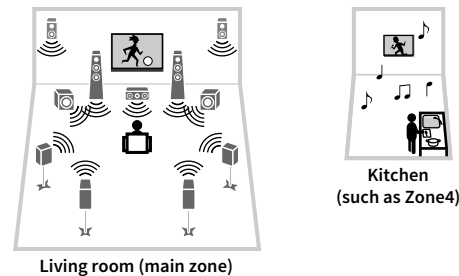

Useful applications

The following applications provide you the flexibility to control the unit or assist you with the cable connections.

AV CONTROLLER



“AV CONTROLLER” will turn your smartphone/tablet into a Wi-Fi enabled remote control for your Yamaha network products. This application provides you the flexibility to control the available inputs, volume, mute, power commands and playback source.

Functions

- Power on/off and volume adjustment
- Input, scene and sound mode selection
- DSP Parameter adjustment
- Playback control (including music selection for some sources)



For details, search for “AV CONTROLLER” on the App Store or Google Play.

MusicCast CONTROLLER



“MusicCast CONTROLLER” is an application that allows you to link a MusicCast compatible device to other MusicCast compatible devices in other rooms and play them back simultaneously. This app lets you use your smartphone or other mobile device instead of the remote control to easily select music to play back as well as configure the unit and MusicCast compatible devices.

Functions

- Selecting and playing back various content
 - Play back music from your mobile device
 - Select an Internet radio station
 - Play back music files stored on media servers (PCs/NAS)
 - Play back music files stored on a USB storage device
- Operating and configuring the unit
 - Select the input source, adjust the volume and mute the audio output
 - Select from a wide variety of sound processing features



For details, search for “MusicCast CONTROLLER” on the App Store or Google Play.

Part names and functions

This section explains the functions of the parts of the unit.

Front panel

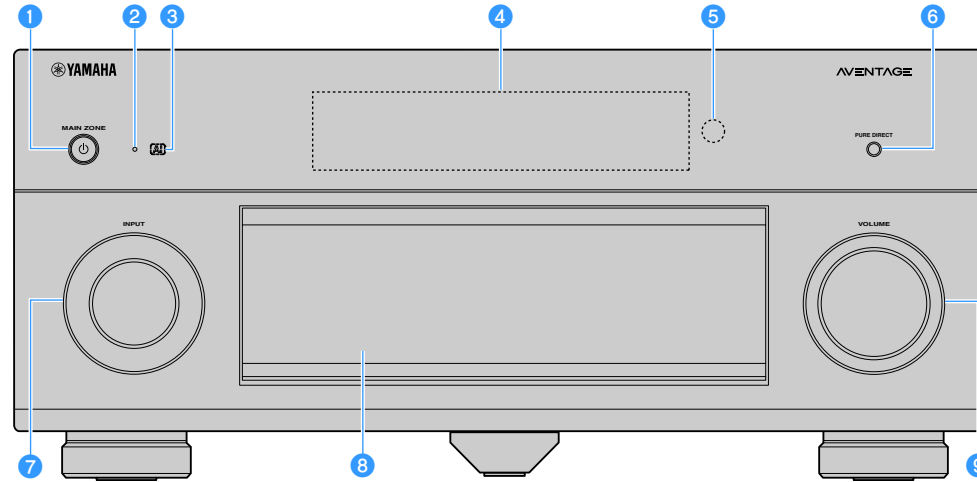

1 MAIN ZONE key

Turns on/off (standby) the unit.

2 Standby indicator

Lights up when the unit is in standby mode under any of the following conditions.

- HDMI Control is enabled (p.134)
- HDMI Standby Through is enabled (p.134)
- Network Standby is enabled (p.136)
- Bluetooth Standby is enabled (p.139)

3 AI indicator

Lights up when the SURROUND:AI is enabled (p.66)

4 Front display

Displays information (p.15).

5 Remote control sensor

Receives remote control signals (p.6).

6 PURE DIRECT key

Enables/disables Pure Direct (p.71).

7 INPUT knob

Selects an input source.

8 Front panel door

For protecting controls and jacks (p.14).

9 VOLUME knob

Adjusts the volume.

Opening the front panel door

To use controls or jacks behind the front panel door, gently press the bottom of the door to open it. Keep the door closed when not using controls or jacks behind the front panel door. (Be careful not to trap your fingers.)

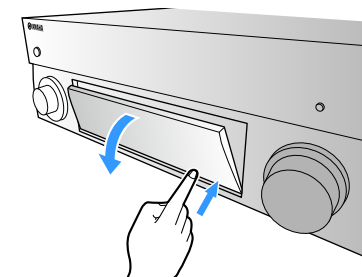

■ Inside of the front panel door

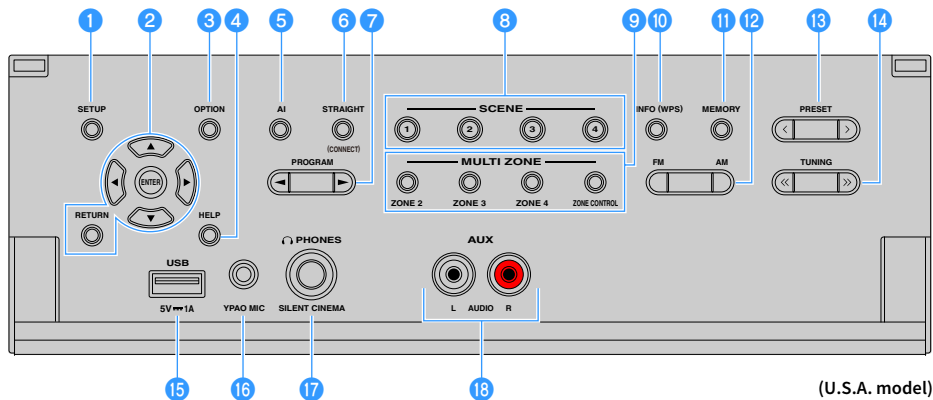

1 SETUP key

Displays the Setup menu on the TV.

2 Menu operations keys

Cursor keys: Select a menu or a parameter.

ENTER: Confirms a selected item.

RETURN: Returns to the previous screen.

3 OPTION key

Displays the option menu (p.108).

4 HELP key

In the on-screen menu, the description of a term in the cursor position appears on the TV. This key is enabled when the “?” icon is displayed on the on-screen menu.

5 AI key

Turns on/off the SURROUND:AI mode (p.66).

6 STRAIGHT (CONNECT) key

Enables/disables the straight decode mode (p.70).

Enters MusicCast CONTROLLER registration by holding down for 5 seconds (p.62).

7 PROGRAM keys

Select a sound program or a surround decoder (p.65).

8 SCENE keys

Select the assigned input source (including the selected radio station or content when it is assigned), sound program, and various settings with one touch. Also, turns on the unit when it is in standby mode (p.64).

9 MULTI ZONE keys

ZONE 2-4: Enables/disables the audio output to each zone (p.103).

ZONE CONTROL: Changes the zone that is controlled by the keys and knobs on the front panel (p.103).

10 INFO (WPS) key

Selects the information displayed on the front display (p.106).

Enters the wireless network connection setup (WPS push button configuration) by holding down for 3 seconds (p.58).

11 MEMORY key

Registers FM/AM/DAB radio stations as preset stations (p.73, p.77, p.82).

Registers USB/network contents or Bluetooth input source as shortcuts (p.105).

12 FM and AM keys (except Australia, U.K., Europe, Middle East and Russia models)

Switch between FM and AM (p.73).

FM and DAB keys (Australia, U.K., Europe, Middle East and Russia models only)

Switch between FM and DAB (p.76, p.73).

13 PRESET keys

Select a preset FM/DAB radio station (p.77, p.83) (Australia, U.K., Europe, Middle East and Russia models) or a preset FM/AM radio station (p.74) (other models).

Selects a USB/network content from shortcuts (p.105).

14 TUNING keys

Select the radio frequency (p.73).

15 USB jack

For connecting a USB storage device (p.86).

16 YPAO MIC jack

For connecting the supplied YPAO microphone (p.44).

17 PHONES jack

For connecting headphones.

18 AUX jacks

For connecting devices, such as CD players (p.37).

Front display (indicators)

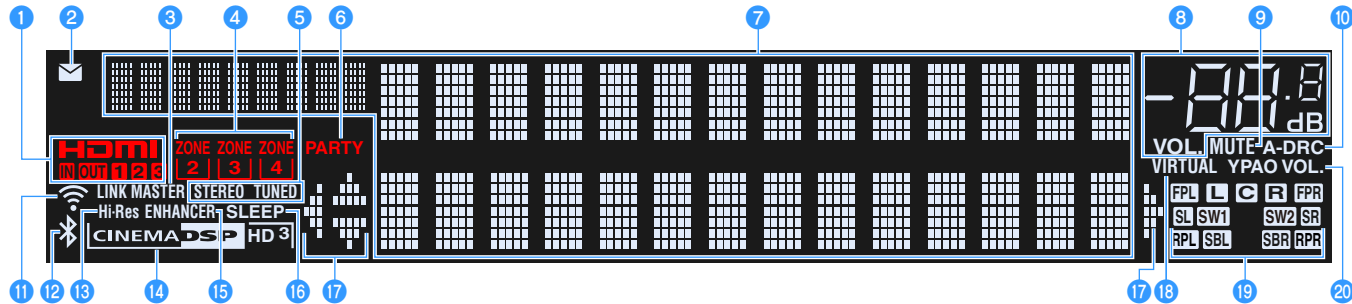

1 HDMI

Lights up when HDMI signals are being input or output.

IN

Lights up when HDMI signals are being input.

OUT1/OUT2/OUT3

Indicates the HDMI OUT jacks currently outputting an HDMI signal.

2 Firmware update indicator

Lights up when a firmware update is available via the network (p.152)

3 LINK MASTER

Lights up when the unit is the master device of the MusicCast network.

4 ZONE indicators

Lights up when Zone2, Zone3 or Zone4 is enabled (p.103).

5 STEREO

Lights up when the unit is receiving a stereo FM radio signal.

TUNED

Lights up when the unit is receiving an FM radio station signal (Australia, U.K., Europe, Middle East and Russia models) or an FM/AM radio station signal (other models).

6 PARTY

Lights up when the unit is in the party mode (p.104).

7 Information display

Displays the current status (such as input name and sound mode name). You can switch the information by pressing INFO (p.106).

8 Volume indicator

Indicates the current volume.

9 MUTE

Blinks when audio is temporarily muted.

10 A-DRC

Lights up when Adaptive DRC (p.110) is working.

11 Wireless LAN indicator

Light up while the unit is connected to a wireless network (p.56).



This indicator may light up when the unit is added to the MusicCast network. For details, see “Adding the unit to the MusicCast network” (p.62).

12 Bluetooth indicator

Lights up when the unit is connecting to a Bluetooth device (p.85).

13 Hi-Res

Lights up when the high-resolution mode (p.111) is working.

14 CINEMA DSP indicator

“CINEMA DSP HD” lights up when CINEMA DSP (p.66) is working.
“CINEMA DSP HD 3” lights up when CINEMA DSP HD³ is activated.

15 ENHANCER

Lights up when Compressed Music Enhancer (p.71) is working.

16 SLEEP

Lights up when the sleep timer is on.

17 Cursor indicators

Indicate the remote control cursor keys currently operational.

18 VIRTUAL

Lights up when the Virtual Presence Speaker (VPS) or Virtual Surround Back Speaker (VSBS) (p.66), or the virtual surround processing (p.69) is working.

19 Channel indicators

Indicate channels (PRE OUT jacks) from which signals are output.

L Front (L)

R Front (R)

C Center

SL Surround (L)

SR Surround (R)

SBL Surround back (L)

SBR Surround back (R)

FPL Front presence (L)

FPR Front presence (R)

RPL Rear presence (L)

RPR Rear presence (R)

SW1 Subwoofer (1)

SW2 Subwoofer (2)

20 YPAO VOL.

Lights up when YPAO Volume is enabled (p.110).

Rear panel

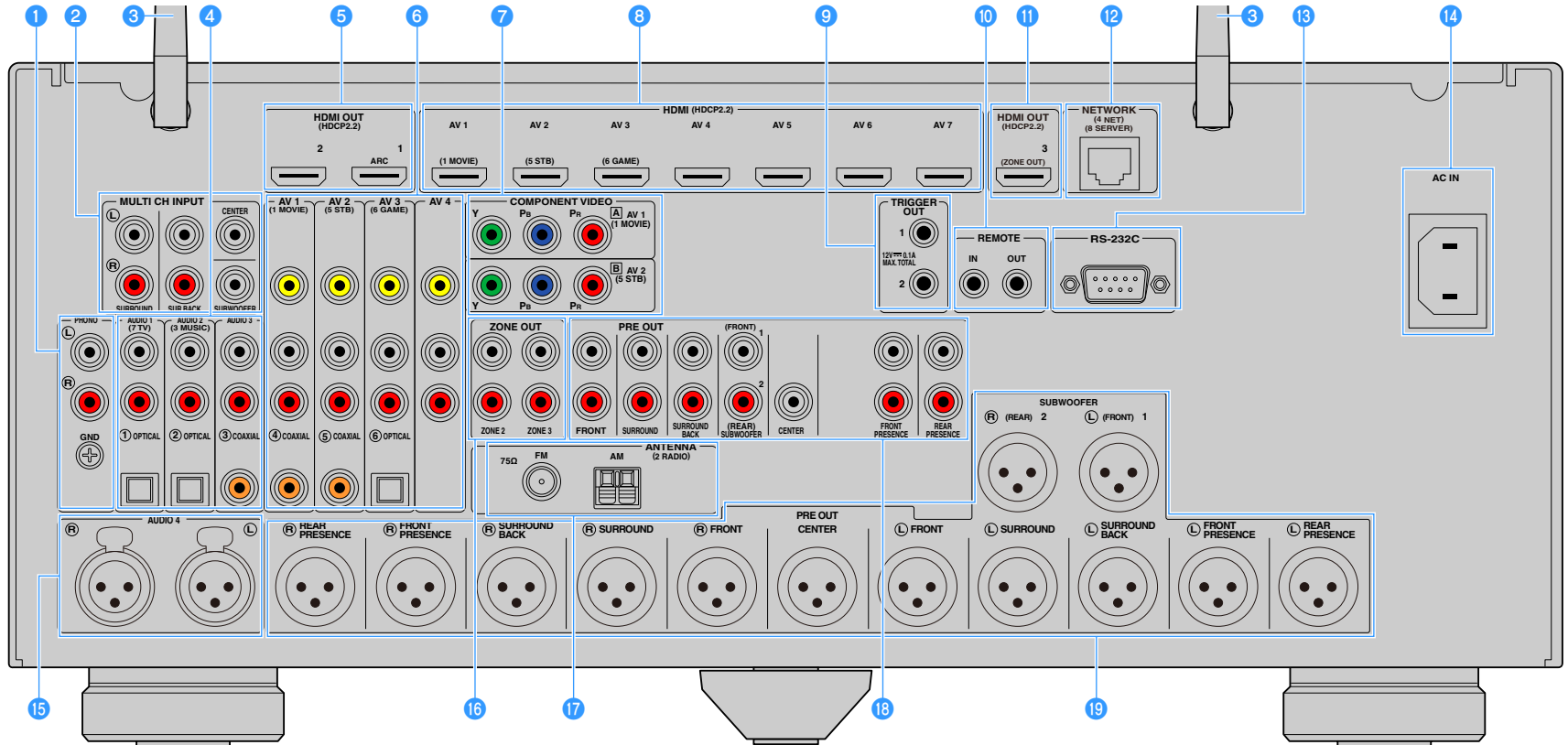

(U.S.A. model)

* The area around the video/audio output jacks is marked in white on the actual product to prevent improper connections.

1 PHONO jacks

For connecting to a turntable (p.36).

2 MULTI CH INPUT jacks

For connecting to a device that supports multichannel output and inputting audio signals (p.40)

3 Wireless antenna

For a wireless (Wi-Fi) connection to a network (p.56) and a Bluetooth connection (p.85).

4 AUDIO 1-3 jacks

For connecting to audio playback devices and inputting audio signals (p.36).

5 HDMI OUT 1-2 jacks

For connecting to an HDMI-compatible TV and outputting video/audio signals (p.33). When using ARC, TV audio signal can also be input through the HDMI OUT 1 jack.

6 AV 1-4 jacks

For connecting to video/audio playback devices and inputting video/audio signals (p.34).

7 COMPONENT VIDEO (AV 1-2) jacks

For connecting to video playback devices that support component video and inputting video signals (p.35).

8 HDMI (AV 1-7) jacks

For connecting to HDMI-compatible playback devices and inputting video/audio signals (p.34).

9 TRIGGER OUT 1-2 jacks

For connecting to devices that support the trigger function (p.40).

10 REMOTE IN/OUT jacks

For connecting to an infrared signal receiver/emitter that allows you to operate the unit and other devices from another room (p.102).

11 HDMI OUT 3 (ZONE OUT) jack

For connecting to an HDMI-compatible device used in Zone2 or Zone4 (p.101).

12 NETWORK jack

For connecting to a network with a network cable (p.39).

13 RS-232C terminal

This is a control expansion terminal for custom installation. Consult your dealer for details.

14 AC IN jack

For connecting the supplied power cable (p.41).

15 AUDIO 4 (XLR) jacks

For connecting to an audio playback device and inputting audio signals (p.36).

16 ZONE OUT jacks

For connecting to an external amplifier used in Zone2 or Zone3 and outputting audio (p.100).

17 ANTENNA jacks

For connecting to radio antennas (p.38).

18 PRE OUT (RCA) jacks

For connecting to a subwoofer with built-in amplifier (p.32) or to a power amplifier (p.31).

19 PRE OUT (XLR) jacks

For connecting to a subwoofer with built-in amplifier (p.31) or a power amplifier (p.30).

Remote control

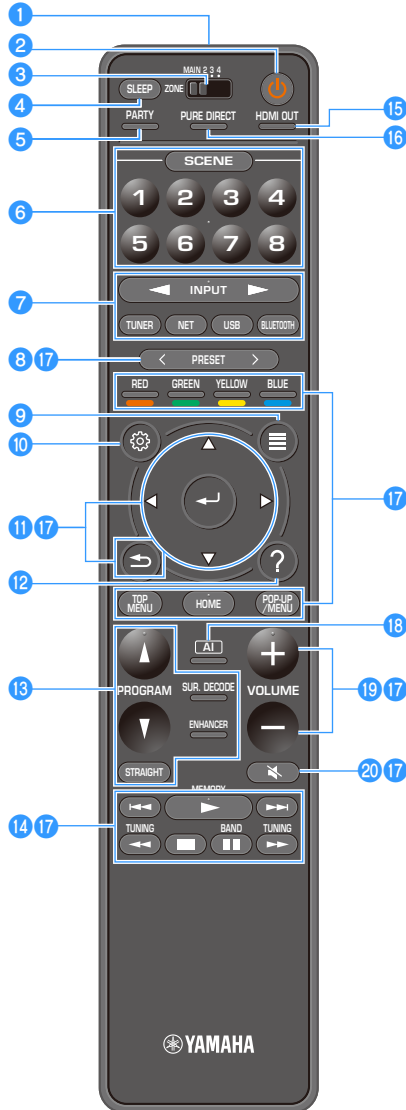

- 1 Remote control signal transmitter**
Transmits infrared signals.
- 2 (receiver power) key**
Turns on/off (standby) the unit.
- 3 MAIN/ZONE switch**
Changes the zone that is controlled by the remote control (p.103).
- 4 SLEEP key**
Pressing this key repeatedly will specify the time (120 min, 90 min, 60 min, 30 min, off), in which the unit switches to the standby mode.
- 5 PARTY key**
Turns on/off the party mode (p.104).
- 6 SCENE keys**
Switch with one touch between multiple settings set using the SCENE function. Also, turn on the unit when it is in standby mode (p.64).
- 7 Input selection keys**
Select an input source for playback.
!
Presses NET repeatedly to select a desired network source.
- 8 PRESET keys**
Select a preset FM/AM radio station (p.73).
Recall USB, Bluetooth, or network content that is registered as a shortcut (p.105).
- 9 OPTION key**
Displays the option menu (p.108).
- 10 SETUP key**
Displays the setup menu (p.115)
- 11 Menu operation keys**
Operates the menu.
- 12 HELP key**
In the on-screen menu, the description of a term in the cursor position appears on the TV. This key is enabled when the “?” icon is displayed on the on-screen menu.
- 13 Sound mode keys**
Select a sound mode (p.65).
- 14 Playback operation keys**
Controls playback of the external device.
- 15 HDMI OUT key**
Selects HDMI OUT jacks to be used for video/audio output (p.63).

- 16 PURE DIRECT key**
Enables/disables the Pure Direct (p.71).
- 17 External device operation keys**
Let you perform playback operations when “Bluetooth”, “USB” or “NET” is selected as the input source, or control playback of the HDMI Control-compatible playback device.
!
The playback devices must support HDMI Control. Some HDMI Control-compatible devices cannot be used.
- 18 AI key**
Turns on/off the SURROUND:AI mode (p.66).
- 19 VOLUME keys**
Adjust the volume.
- 20 MUTE key**
Mutes the audio output.

PREPARATIONS

General setup procedure

- 1** Placing speakers (p.20)
- 2** Connecting the power amplifier and subwoofers (p.30)
- 3** Connecting a TV and playback devices (p.33)
- 4** Connecting the radio antennas (p.38)
- 5** Connecting a network cable or preparing the wireless antenna (p.39)
- 6** Connecting other devices (p.40)
- 7** Connecting the power cable (p.41)
- 8** Selecting an on-screen menu language (p.42)
- 9** Configuring the necessary speaker settings (p.43)
- 10** Optimizing the speaker settings automatically (YPAO) (p.44)
- 11** Connecting to a network device wirelessly (p.56)
- 12** Connecting to the MusicCast network (p.62)

This completes all the preparations. Enjoy playing movies, music, radio and other content with the unit!

1 Placing speakers

The unit has 11.2-channel pre-amplifiers. You can connect 2 to 11 channel speakers (via a power amplifier) and up to 2 subwoofers to create the favorite acoustic space in your room. You can also apply multi-zone configurations to enhance your system (p.99).

Ideal speaker layout

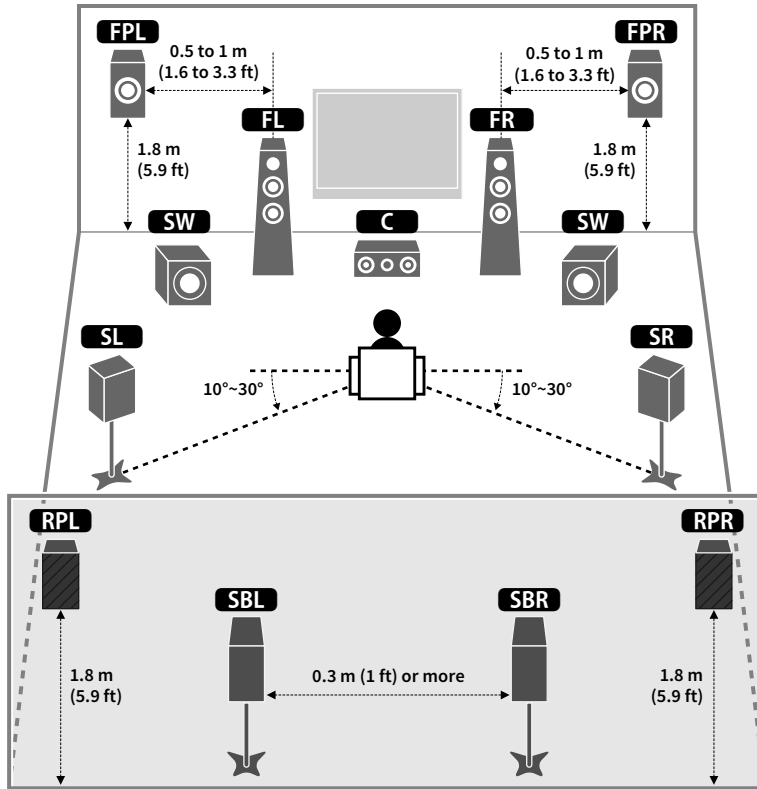

Functions of each speaker

Speaker type	Function
Front (L/R) FL FR	Produce front left/right channel sounds (stereo sounds).
Center C	Produces center channel sounds (such as movie dialogues and vocals).
Surround (L/R) SL SR	Produce surround left/right channel sounds. Surround speakers also produce surround back channel sounds when no surround back speakers are connected.
Surround back (L/R) SBL SBR	Produce surround back left/right channel sounds.
Front presence (L/R) FPL FPR	Produce CINEMA DSP effect sounds or heights channel sounds of Dolby Atmos and DTS:X contents.
Rear presence (L/R) RPL RPR	Produce CINEMA DSP effect sounds or heights channel sounds of Dolby Atmos and DTS:X contents.
Subwoofer SW	Produces LFE (low-frequency effect) channel sounds and reinforces bass parts of other channels. This channel is counted as "0.1". You can connect 2 subwoofers to the unit and place them on the left/right (or front/rear) sides of the room.



- Use "Ideal speaker layout" (diagram on the left) as reference. You do not need to exactly adjust the speaker layout to this diagram since the YPAO function of the unit will automatically optimize the speaker settings (such as distances) to suit the speaker layout.
- The unit creates front Virtual Presence Speaker (VPS) using the front, center, and surround speakers to produce 3-dimensional sound fields even when no front presence speakers are connected. However, we recommend using front presence speakers in order to experience the full effect of the sound fields (and rear presence speakers for further spatial sounds).
- The unit creates rear Virtual Presence Speaker (VPS) using the front, center, and surround speakers to produce natural 3-dimensional sound fields when front presence speakers are connected but no rear presence speakers.

Basic speaker configuration

If you do not multi-zone configurations, follow the procedure below to place the speakers in your room and connect them to the unit.

■ Placing speakers in your room

Depending on the number of speakers, place the speakers and subwoofer in your room. This section describes the representative speaker layout examples.



- To have a full effect of Dolby Atmos contents, we recommend using a speaker system with a ★ mark. However, you can also play back Dolby Atmos contents with the 7.1 system (using surround back speakers).
- To have a full effect of DTS:X contents, we recommend using a speaker system with a ★ mark.
- (About the number of channels) For example, “5.1.2” denotes “standard 5.1-channel plus 2 for overhead speaker channels”. For details on how to place overhead speakers (presence speakers), see “Presence speaker layout” (p.26).

11.2-channel system [★7.2.4]

(using both surround back and rear presence speakers)

This speaker system brings out the full performance of the unit and allows you to enjoy a highly-natural 3-dimensional sound field with any contents.

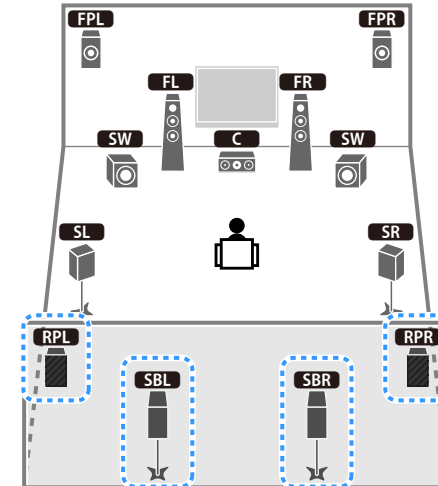

- When Zone3 output is enabled (p.103), the rear presence left/right channel output is not available in the main zone.
- When using front presence and rear presence speakers installed to the ceiling or when using the Dolby Enabled speakers as the presence speakers, configure the “Layout (Front Presence/Rear Presence)” setting in the “Setup” menu before performing YPAO (p.43).

9.2-channel system [★5.2.4] (using rear presence speakers)

This speaker system uses the front and rear presence speakers to produce a highly-natural 3-dimensional sound field, and also creates Virtual Surround Back Speaker (VSBS) using the surround speakers to add a sense of depth to the rear sound field. This system is suited for enjoying not only 5.1-channel but also for 7.1-channel contents.

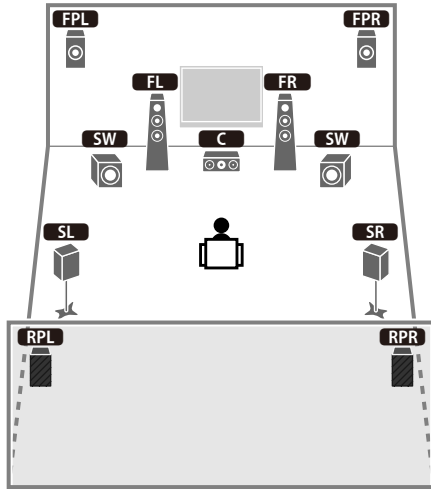

- When Zone3 output is enabled (p.103), the rear presence right/left channel output is not available in the main zone.
- When using front presence and rear presence speakers installed to the ceiling or when using the Dolby Enabled speakers as the presence speakers, configure the “Layout (Front Presence/Rear Presence)” setting in the “Setup” menu before performing YPAO (p.43).

9.2-channel system [★7.2.2] (using surround back speakers)

This speaker system uses the front presence speakers to produce a natural 3-dimensional sound field, and also allows you to enjoy extended surround sounds using the surround back speakers.

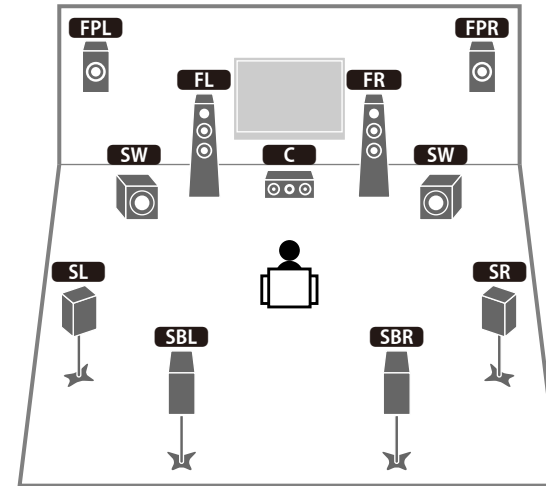

- When using front presence speakers installed to the ceiling or when using the Dolby Enabled speakers as the presence speakers, configure the “Layout (Front Presence)” setting in the “Setup” menu before performing YPAO (p.43).
- This speaker system creates rear Virtual Presence Speaker (VPS) using the front, center and surround speakers to produce a natural 3-dimensional sound field.

7.1-channel system [★5.1.2] (using front presence speakers)

This speaker system uses the front presence speakers to produce a natural 3-dimensional sound field, and also creates Virtual Surround Back Speaker (VSBS) using the surround speakers to add a sense of depth to the rear sound field. This system is suited for enjoying not only 5.1-channel but also for 7.1-channel contents.

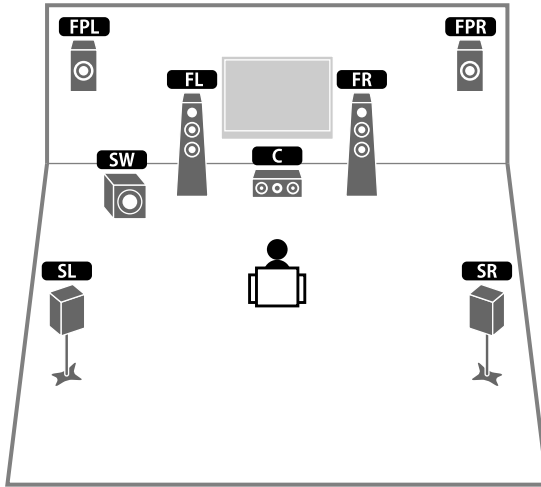

- When using front presence speakers installed to the ceiling or when using the Dolby Enabled speakers as the presence speakers, configure the “Layout (Front Presence)” setting in the “Setup” menu before performing YPAO (p.43).
- This speaker system creates rear Virtual Presence Speaker (VPS) using the front, center and surround speakers to produce a natural 3-dimensional sound field.

7.1-channel system [★7.1.0] (using surround back speakers)

This speaker system creates front Virtual Presence Speaker (VPS) using the front, center and surround speakers to produce a 3-dimensional sound field, and also allows you to enjoy extended surround sounds using the surround back speakers.

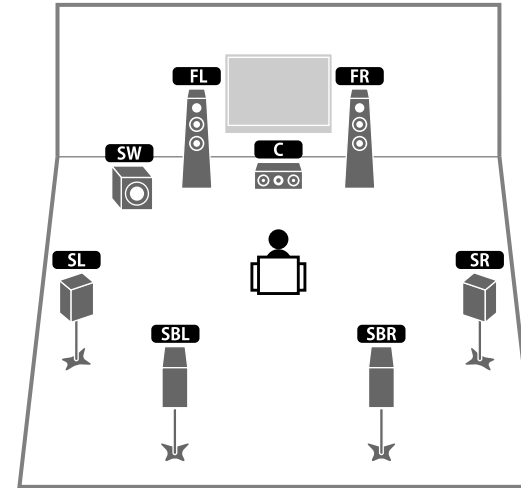

5.1-channel system

This speaker system creates Virtual Presence Speaker (VPS) using the front, center and surround speakers to produce a 3-dimensional sound field, and also creates Virtual Surround Back Speaker (VSBS) using the surround speakers to add a sense of depth to the rear sound field. This system is suited for enjoying not only 5.1-channel but also for 7.1-channel contents.

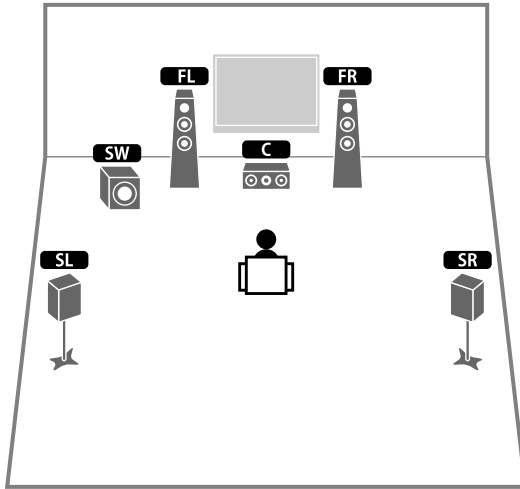

Front 5.1-channel system (using surround speakers)

Even when surround speakers are placed in the front side, the unit creates the virtual surround speakers in the rear side to allow you to enjoy multichannel surround sound (Virtual CINEMA FRONT) when “Layout (Surround)” (p.122) in the “Setup” menu is set to “Front”.

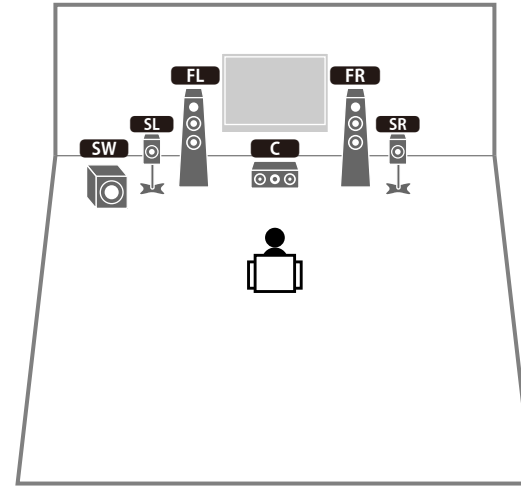

You can enjoy surround sound even without the center speaker (front 4.1-channel system).

Front 5.1-channel system (using front presence speakers)

This speaker system uses the front presence speakers to produce a natural 3-dimensional sound field, and creates the virtual surround speakers using the front speakers to allow you to enjoy multichannel surround sound (Virtual CINEMA DSP).

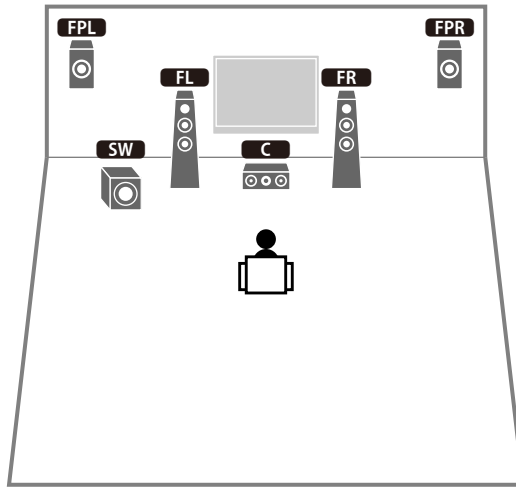

When using front presence speakers installed to the ceiling or when using the Dolby Enabled speakers as the presence speakers, configure the “Layout (Front Presence)” setting in the “Setup” menu before performing YPAO (p.43).

2.1-channel system

Even when no surround speakers are connected, the unit creates the virtual surround speakers using the front speakers to allow you to enjoy multichannel surround sound (Virtual CINEMA DSP).

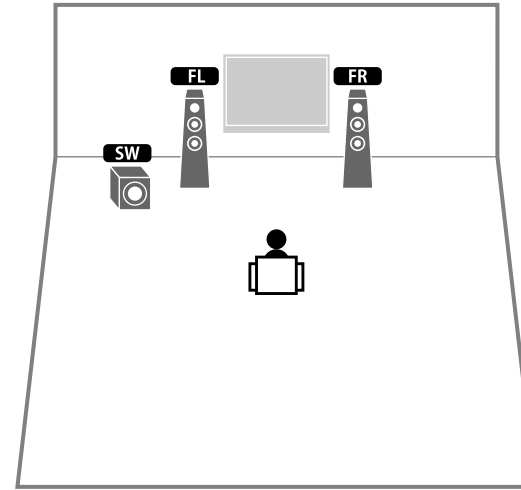

Add the center speaker to configure a 3.1 system.

Presence speaker layout

The unit provides three layout patterns for presence speakers (Front Height/Rear Height, Overhead and Dolby Enabled SP). Choose a layout pattern that suits your listening environment (p.122).



- You can enjoy Dolby Atmos, DTS:X or Cinema DSP HD³ with any layout pattern.
- You can configure the placement patterns for front presence and rear presence speakers separately (p.122).

Front Height/Rear Height

Install the presence speakers on the front/rear side wall.

It delivers a natural sound field with excellent linkage of left, right, top and bottom sound spaces, and sound extensity effectively.



Overhead

Install the presence speakers to the ceiling above the listening position.

It delivers realistic overhead sound effects and sound field with excellent linkage of front and rear sound spaces effectively.



For details on the installation position of ceiling speakers, see “Notes on installation of ceiling speakers” (p.26).

Dolby Enabled SP

Use the Dolby Enabled speakers as the presence speakers.

It utilizes sounds reflected from ceiling and lets you enjoy overhead sounds only from speakers that are placed at the same level as traditional speakers.



Place the Dolby Enabled speakers on top of or near the traditional front speakers. A Dolby Enabled speaker unit may be integrated into a traditional speaker. For details, refer to the instruction manual of the Dolby Enabled speakers.

Notes on installation of ceiling speakers

When installing presence speakers to a ceiling, use the following illustration as a reference.

When using two presence speakers

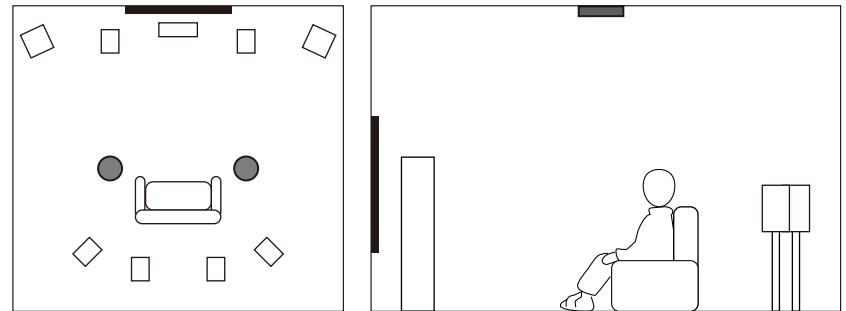

Installation position

Just above the listening position, or the ceiling between extensions of front speakers and listening position

When using four presence speakers

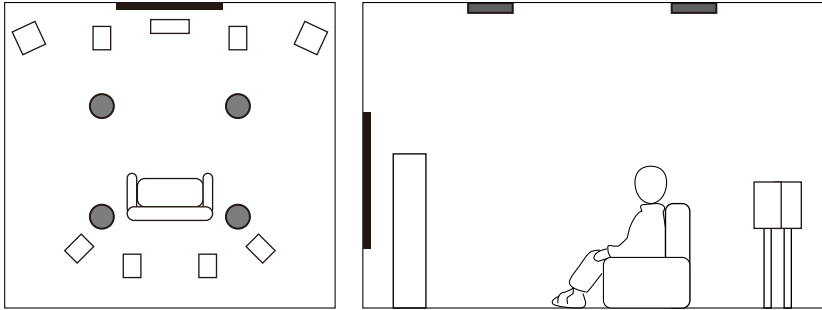

Installation position

Front presence speakers:

the ceiling between the extensions of the front speakers and listening position

Rear presence speakers:

the ceiling between the extensions of the listening position and surround (or surround back) speakers

Caution

Be sure to use speakers that are made for ceiling use and take anti-drop measures. Ask a qualified contractor or dealer personnel for installation works.

Input/output jacks and cables

The unit is equipped with the following input/output jacks. Prepare the cables that match the jacks on your devices.

Video/audio jacks

To input/output video and audio signals, use the following jacks.

HDMI jacks

Transmit digital video and digital sound through a single jack. Use an HDMI cable.

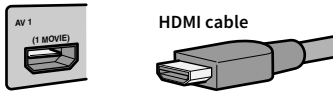

Use a 19-pin HDMI cable with the HDMI logo. We recommend using a cable less than 5.0 m (16.4 ft) long to prevent signal quality degradation.



- The unit's HDMI jacks support the HDMI Control, Audio Return Channel (ARC), and 3D and 4K Ultra HD video transmission features.
- Use high speed HDMI cables to enjoy 3D or 4K Ultra HD videos.

Video jacks

To input only video signals, use the following jacks.

COMPONENT VIDEO jacks

Transmit video signals separated into three components: luminance (Y), chrominance blue (Pb), and chrominance red (Pr). Use a component video cable with three plugs.

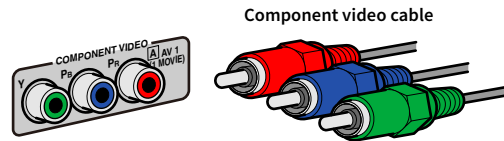

VIDEO jacks

Transmit analog video signals. Use a video pin cable.

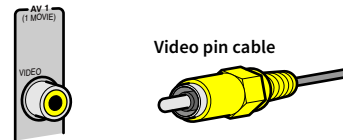

Audio jacks

To input/output only audio signals, use the following jacks.

OPTICAL jacks

Transmit digital audio signals. Use a digital optical cable. Remove the tip protector (if available) before using the cable.

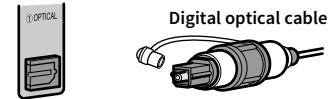

COAXIAL jacks

Transmit digital audio signals. Use a digital coaxial cable.



AUDIO jacks

Transmit analog stereo audio signals. Use a stereo pin cable (RCA cable).

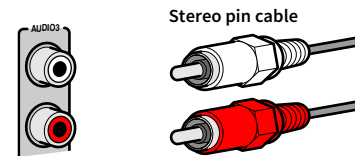

XLR jacks

Transmit analog audio signals. Use an XLR balanced cable.

XLR input jacks

Match the pins and insert the “male” connector of the XLR balanced cable until you hear a click.

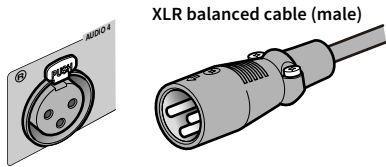

When disconnecting the cable from the unit, hold down the PUSH button on the unit and then pull the connector out.

XLR output jacks

Match the pins and insert the “female” connector of the XLR balanced cable until you hear a click.

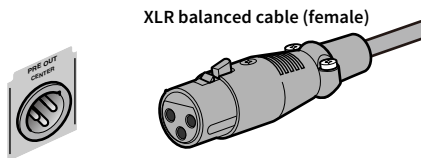

When disconnecting the cable from the unit, hold down the lever of the connector and then pull it out.

About the XLR jacks

- The pin assignments for the XLR jacks of the unit are shown below. Before connecting an XLR balanced cable, refer to the instruction manual of your device and verify that its XLR jacks are compatible with the pin assignments.

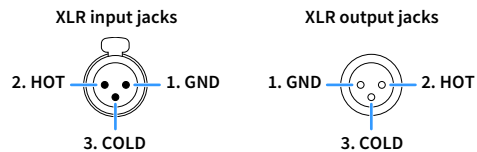

2 Connecting the power amplifier and subwoofers

Connect the power amplifier and subwoofer (with built-in amplifier) to the unit.

Connecting a power amplifier

Connect the input jacks of your power amplifier to the PRE OUT jacks of the unit so that the audio source selected on the unit can be output to the power amplifier for playback.

Select a balanced (XLR) or an unbalanced (RCA) connection for each channel depending on the input jacks available on your power amplifier.



The XLR jacks and RCA jacks for each channel output the same signals.

Caution

To prevent the generation of loud noises or abnormal sounds, make sure you remove the power cable of the unit and turn off the power amplifier before making connections.

Balanced connection

Depending on the speaker system you want to use, connect the corresponding PRE OUT (XLR) jacks of the unit to the amplifier with XLR balanced cables.



- Before connecting XLR balanced cables, refer to the instruction manual of your power amplifier and verify that its XLR jacks are compatible with the pin assignments of the unit (p.29).
- We recommend using a power amplifier with volume control bypass (or without volume control circuit).

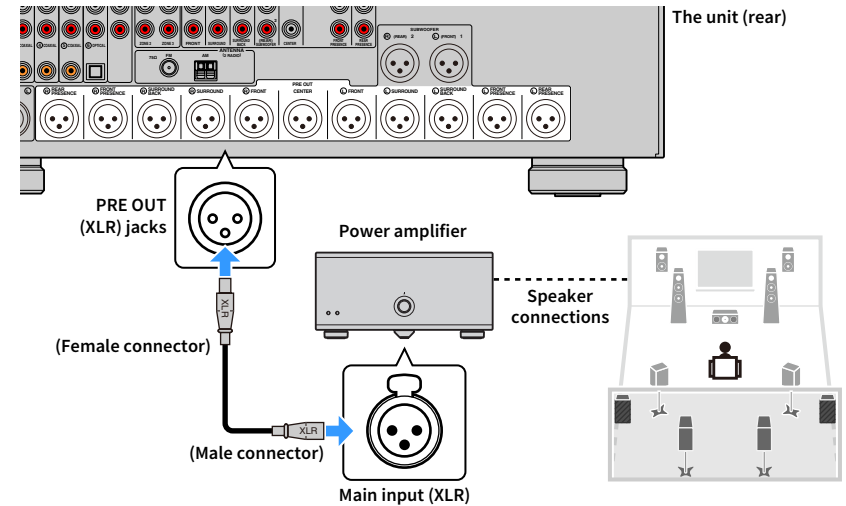

Unbalanced connection

Depending on the speaker system you want to use, connect the corresponding PRE OUT (RCA) jacks of the unit to the amplifier with audio pin cables (RCA unbalanced cables).



We recommend using a power amplifier with volume control bypass (or without volume control circuit).

The unit (rear)

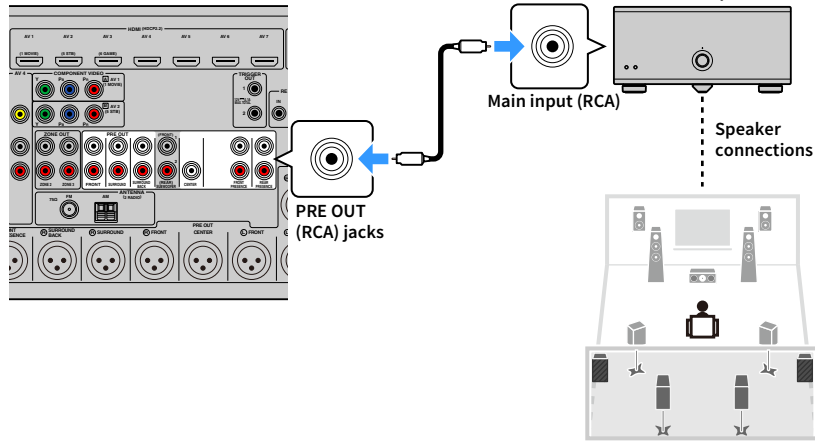

Connecting subwoofers

Connect the subwoofers (with built-in amplifier) to the PRE OUT jacks of the unit.

Select a balanced (XLR) or an unbalanced (RCA) connection depending on the input jacks available on your subwoofer.



- The XLR jacks and RCA jacks output the same signals.
- You can also connect up to 2 subwoofers (with built-in amplifier) to the unit. When using 2 subwoofers, configure the “Layout (Subwoofer)” setting (p.123) in the “Setup” menu after connecting the power cable to an AC wall outlet.

Caution

To prevent the generation of loud noises or abnormal sounds, make sure you remove the power cable of the unit and turn off the subwoofer before making connections.

Balanced connection

Connect the subwoofers (with built-in amplifier) to the SUBWOOFER PREOUT (XLR) 1-2 jacks of the unit with XLR balanced cables.



Before connecting XLR balanced cables, refer to the instruction manual of your subwoofer and verify that its XLR jacks are compatible with the pin assignments of the unit (p.29).

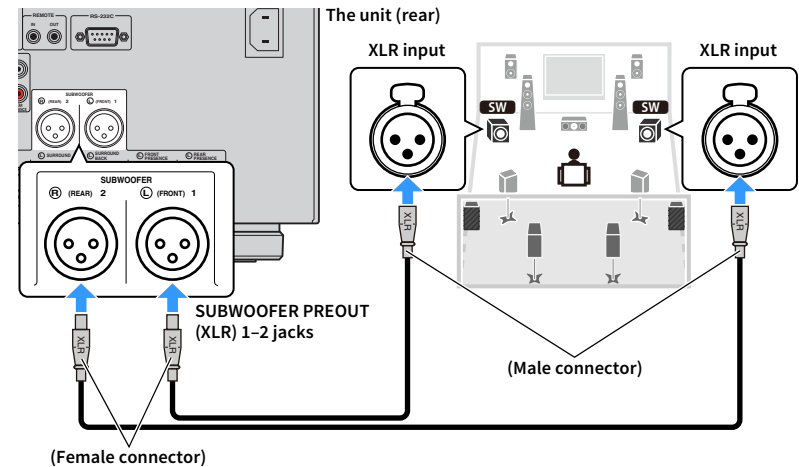

■ Unbalanced connection

Connect the subwoofers (with built-in amplifier) to the SUBWOOFER PREOUT (RCA) 1-2 jacks of the unit with audio pin cables (RCA unbalanced cables).

The unit (rear)

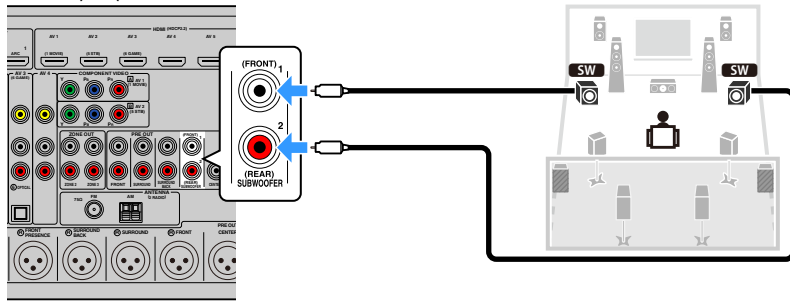

3 Connecting a TV and playback devices

The unit is equipped with a variety of input jacks including HDMI input jacks to allow you to connect different types of playback devices.

Connecting a TV

Connect a TV to the unit so that video input to the unit can be output to the TV.

You can also enjoy playback of TV audio on the unit.

HDMI connection

Connect the TV to the unit with an HDMI cable and an audio cable (digital optical or stereo pin cable).



You can connect another TV or a projector by using the HDMI OUT 2 jack (p.34).

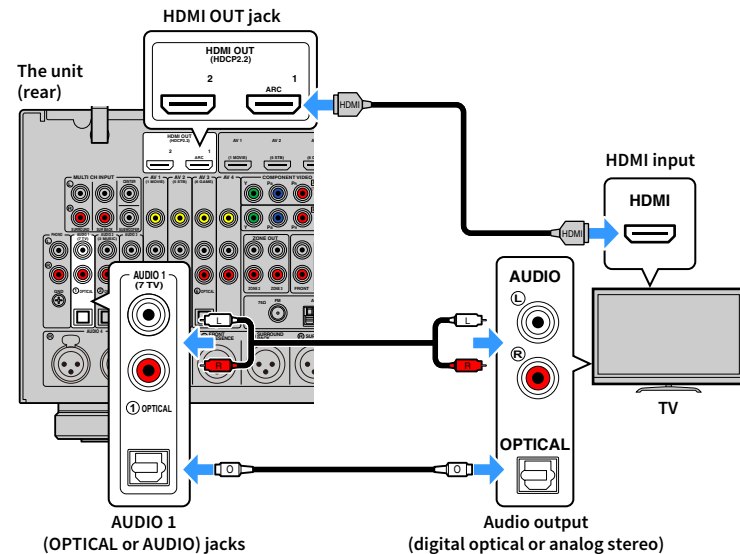

You do not make an audio cable connection between the TV and the unit in the following cases:

- If your TV supports Audio Return Channel (ARC)
- If you will receive TV broadcasts only from the set-top box
- If you connect a TV that supports HDMI Control to the unit with an HDMI cable, you can control the unit's power and volume with the TV's remote control.

To use HDMI Control and ARC, you need to configure the HDMI settings on the unit. For details on the settings, see "Information on HDMI" (p.169).

About Audio Return Channel (ARC)

- ARC allows audio signals to travel both ways. If you connect a TV that supports ARC to the unit with a single HDMI cable, you can output video/audio to the TV or input TV audio to the unit.
- When using ARC, connect a TV with an HDMI cable that supports ARC.

Connecting another TV or projector

If a second TV or projector is connected to the HDMI OUT 2 jack, you can use the remote control to switch the TV (or projector) to be used for watching video (p.63). In addition, a TV, etc., placed in Zone 2 can be connected to the HDMI OUT 3 (ZONE OUT) jack on the unit (p.101).

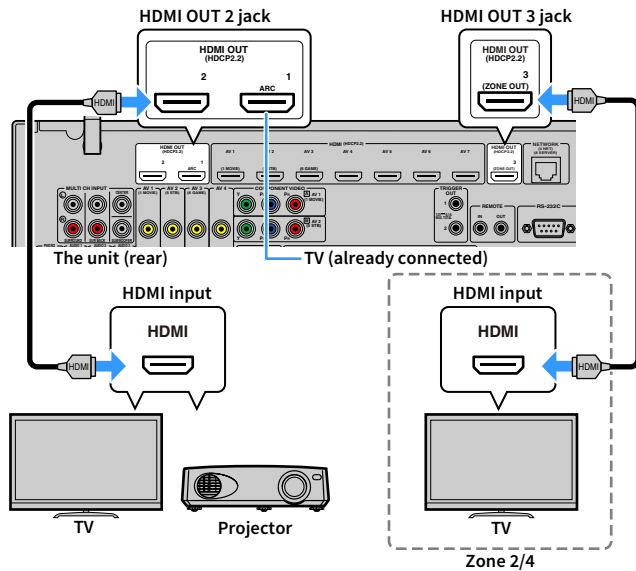

- HDMI Control is not available on the HDMI OUT 2 and 3 jack.
- You can connect a video monitor in Zone2 or Zone4 to the HDMI OUT 3 jack in order to enjoy video and audio. The zone to be used can be selected with "HDMI ZONE OUT Assign" (p.135) in the "Setup" menu.

Connecting video devices (such as BD/DVD players)

Connect video devices such as BD/DVD players, set-top boxes (STBs) and game consoles to the unit. Depending on the video/audio output jacks available on your video device, choose one of the following connections. We recommend using an HDMI connection if the video device has an HDMI output jack.



The following explanation is based on the assumption that you have not changed the "Input Assignment" setting (p.142) in the "Setup" menu. As necessary, you can assign the COMPONENT VIDEO (A, B), COAXIAL (C, D, E) and OPTICAL (F, G, H) jacks to another input source.



If you make more than one audio connection for one input source, an audio signal played back on the unit will be determined according to the "Audio Select" setting (p.112) in the "Option" menu.

HDMI connection

Connect a video device to the unit with an HDMI cable.

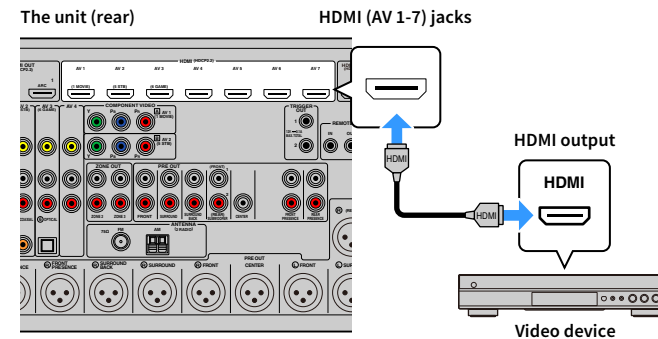

Component video connection

Connect a video device to the unit with a component video cable and an audio cable (digital coaxial or stereo pin cable).

Output jacks on video device		Input jacks on the unit
Video	Audio	
Component video	Digital coaxial	AV 1-2 (COMPONENT VIDEO + COAXIAL)
	Analog stereo	AV 1-2 (COMPONENT VIDEO + AUDIO)

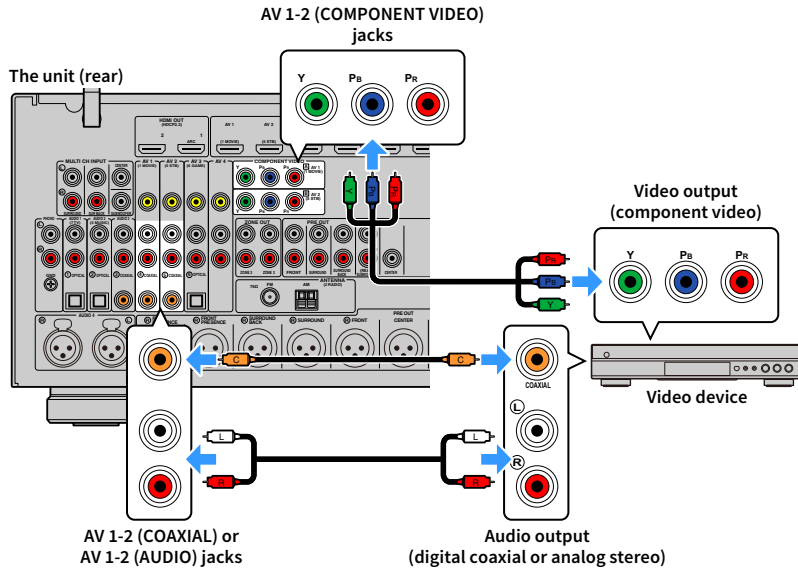

To connect a video device to the unit with a component video cable and a digital optical cable, use “Input Assignment” (p.142) in the “Setup” menu to assign the COMPONENT VIDEO and OPTICAL jacks to the same input source.

Composite video connection

Connect a video device to the unit with a video pin cable and an audio cable (digital coaxial, digital optical, or stereo pin cable). Choose a set of input jacks (on the unit) depending on the audio output jacks available on your video device.

Output jacks on video device		Input jacks on the unit
Video	Audio	
Composite video	Digital coaxial	AV 1-2 (VIDEO + COAXIAL)
	Digital optical	AV 3 (VIDEO + OPTICAL)
	Analog stereo	AV 1-4 (VIDEO + AUDIO)

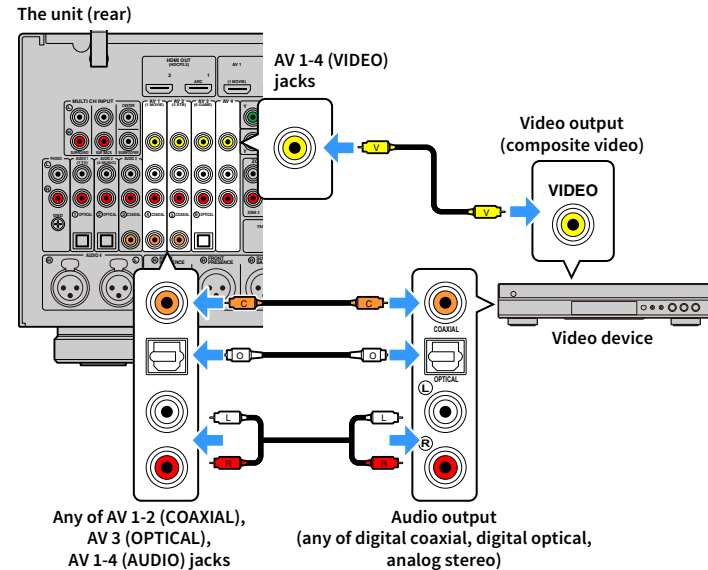

Connecting audio devices (such as CD players)

Connect audio devices such as CD players and a turntable to the unit. Depending on the audio output jacks available on your audio device, choose one of the following connections.



- The following explanation is based on the assumption that you have not changed the “Input Assignment” setting (p.142) in the “Setup” menu. As necessary, you can assign the COAXIAL (Ⓢ, Ⓣ, Ⓤ) and OPTICAL (Ⓛ, Ⓜ, Ⓨ) jacks to another input source.
- Before connecting XLR balanced cables, refer to the instruction manual of your audio device and verify that its XLR jacks are compatible with the pin assignments of the unit (p.29).



If you make more than one audio connection for one input source, an audio signal played back on the unit will be determined according to the “Audio Select” setting (p.112) in the “Option” menu.

Audio output jacks on audio device	Audio input jacks on the unit
Digital coaxial	AV 1-2 (COAXIAL) AUDIO 3 (COAXIAL)
Digital optical	AV 3 (OPTICAL) AUDIO 1-2 (OPTICAL)
Analog stereo (RCA)	AV 1-4 (AUDIO [RCA]) AUDIO 1-3 (AUDIO [RCA])
Analog stereo (XLR)	AUDIO 4 (AUDIO [XLR])
Turntable (PHONO)	PHONO

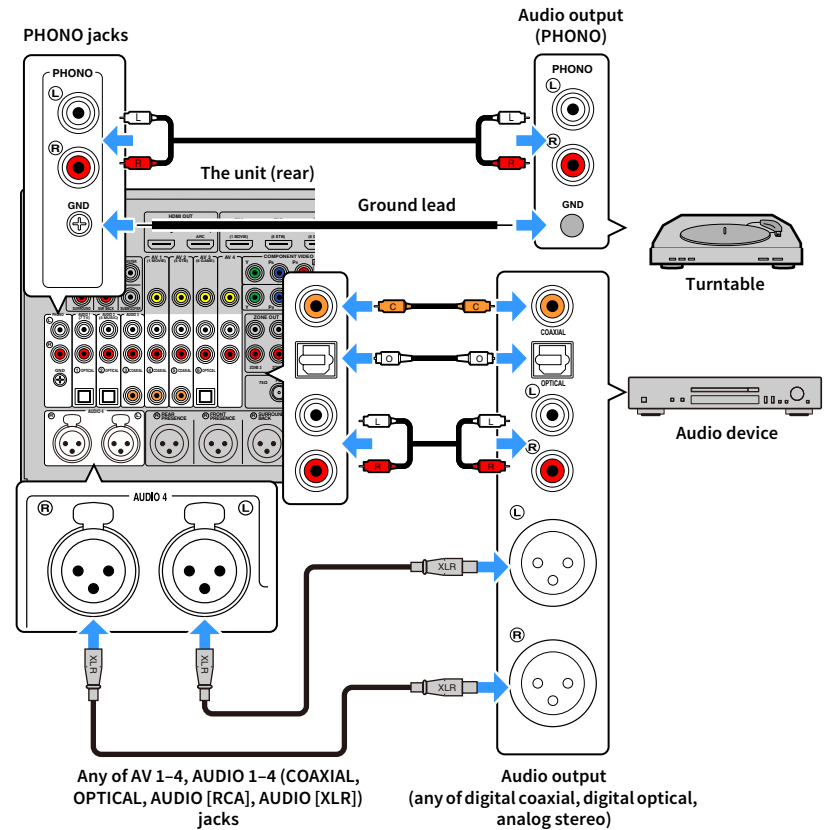

When connecting a turntable

- The PHONO jack of the unit is compatible with an MM cartridge. To connect a turntable with a low-output MC cartridge, use a boosting transformer.
- Connecting the turntable to the GND terminal of the unit may reduce noise in the signal.

Connecting to the jacks on the front panel

The AUX jacks are convenient for temporarily connecting an audio playback device.

Use stereo pin cables to connect an audio device (such as a CD player) to the unit.

For details on connecting a USB device to the USB jack, see “Connecting a USB storage device” (p.86).



Before making connections, stop playback on the device, and turn down the volume of the unit sufficiently.

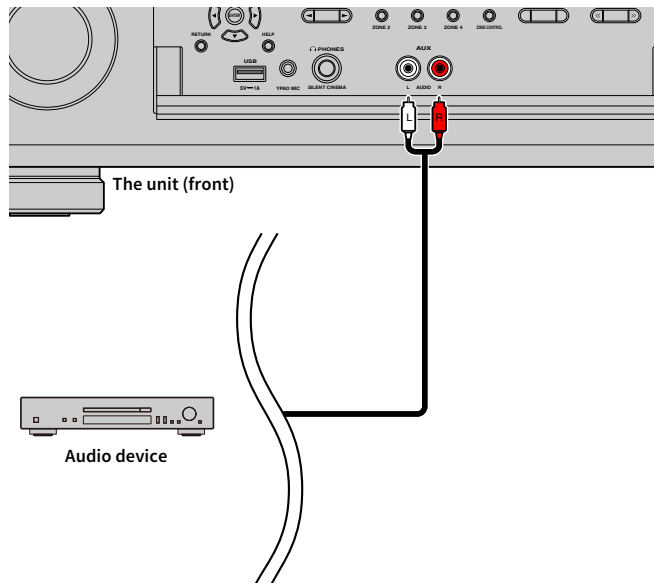

4 Connecting the radio antennas

Connect the supplied radio antenna to the unit.

FM/AM antennas (except Australia, U.K., Europe, Middle East and Russia models)

Connect the supplied FM/AM antennas to the unit.

Fix the end of the FM antenna to a wall, and place the AM antenna on a flat surface.

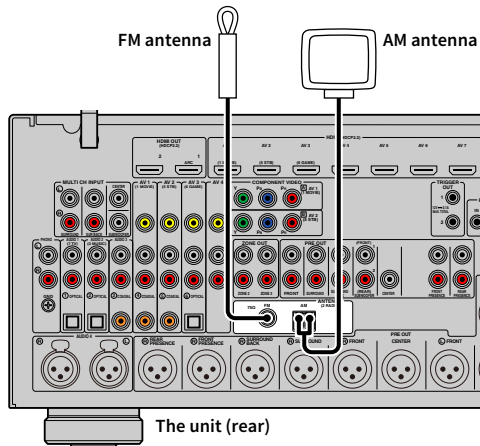

Assembling the AM antenna

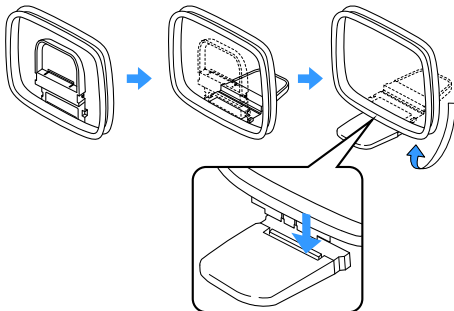

Connecting the AM antenna

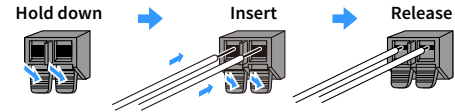

- Unwind only the length of cable needed from the AM antenna unit.
- The wires of the AM antenna have no polarity.

DAB/FM antenna (Australia, U.K., Europe, Middle East and Russia models only)

Connect the supplied DAB/FM antenna to the unit and fix the antenna ends to a wall.

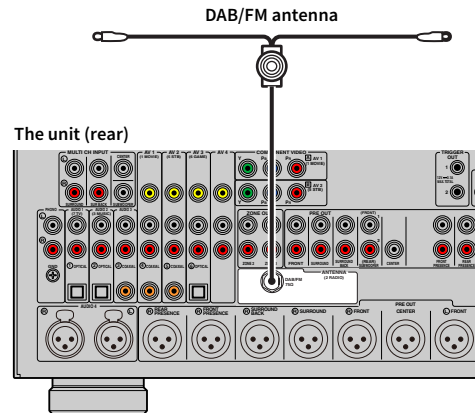

- The antenna should be stretched out horizontally.
- If you cannot obtain good reception on the radio, adjust the height, direction or placement of the DAB/FM antenna.

5 Connecting a network cable or preparing the wireless antenna

Connect the unit to a router (access point) with a network cable, or prepare the wireless antenna for establishing a wireless network connection.

You can enjoy Internet radio or music files stored on media servers, such as PCs and Network Attached Storage (NAS), on the unit.

Connecting the network cable

Connect the unit to your router with a commercially-available STP network cable (CAT-5 or higher straight cable).

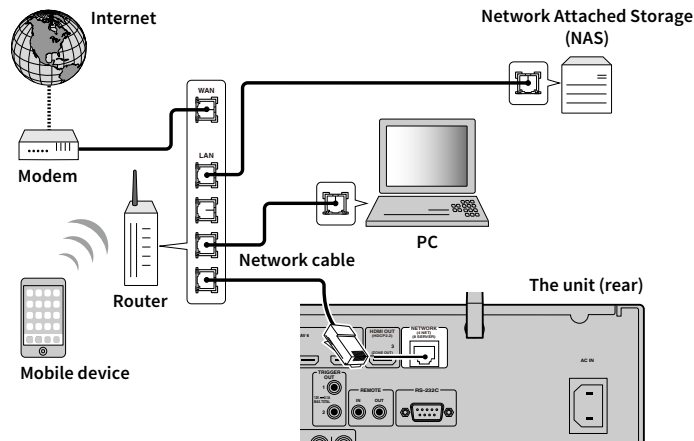

- If you want to use a wired (network cable) connection when a wireless connection has been made, set “Network Connection” (p.136) in the “Setup” menu to “Wired”.
- If you are using a router that supports DHCP, you do not need to configure any network settings for the unit, as the network parameters (such as the IP address) will be assigned automatically to it. You only need to configure the network settings if your router does not support DHCP or if you want to configure the network parameters manually (p.136).
- You can check whether the network parameters (such as IP address) are properly assigned to the unit in “Information” (p.125) in the “Network” menu.



- Some security software installed on your PC or the firewall settings of network devices (such as a router) may block the access of the unit to the network devices or the Internet. In these cases, configure the security software or firewall settings appropriately.
- Each server must be connected to the same subnet as the unit.
- To use the service via the Internet, broadband connection is strongly recommended.

Preparing the wireless antenna

If you want to establish a wireless network connection and Bluetooth connection, stand the wireless antenna up straight.

For information on how to connect the unit to a network device wirelessly, see “Connecting to a network device wirelessly” (p.56).

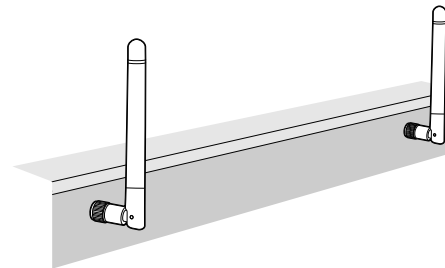

Do not apply excessive force on the antenna. Doing so may damage it.

6 Connecting other devices

Connections with other devices are as shown below.

Connecting a device with analog multichannel output

You can connect an analog multichannel output device such as a DVD player and an SACD player to the MULTI CH INPUT jacks.



The front channel output should be connected to the AUDIO 3 (AUDIO) jacks of the unit.

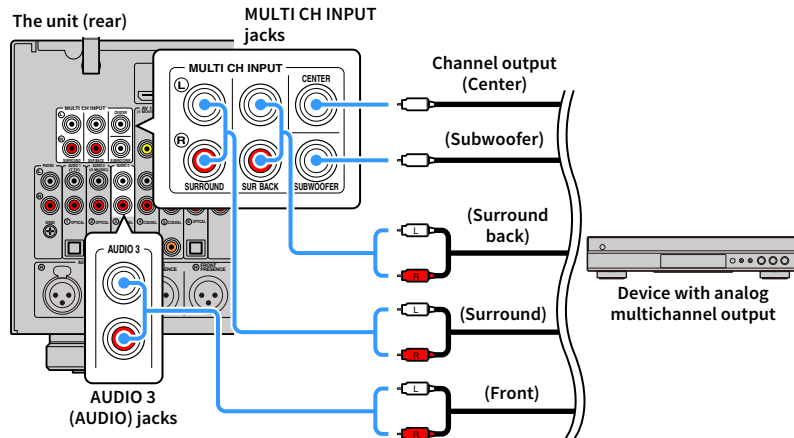

- You can select a video source to be displayed when “MULTI CH” is selected as the input source using “Video Out” (p.113) in the “Option” menu. When connecting a video device (such as a DVD player) to the MULTI CH INPUT jacks, use the input jack specified in “Video Out” for the video connection.
- Since the unit does not redirect signals input to the MULTI CH INPUT jacks to accommodate for missing speakers, make appropriate settings on the external device (such as a DVD player) that suit to the speaker configuration.
- When “MULTI CH” is selected as the input source, sound mode selection and tone control adjustment are not available.

Connecting a device compatible with the trigger function

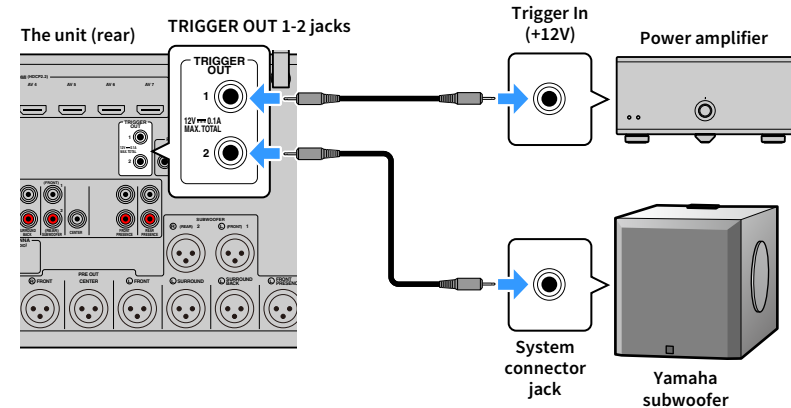

The trigger function can control an external device in conjunction with operating the unit (such as powering on/off and input selection). If you have a power amplifier or a Yamaha subwoofer that supports a system connection or a device with a trigger input jack, you can use the trigger function by connecting the external device to one of the TRIGGER OUT jacks with a monaural mini-plug cable.



You can configure the trigger function settings in “Trigger Output1” and “Trigger Output2” (p.145) in the “Setup” menu.

8 Selecting an on-screen menu language

Select the desired on-screen menu language from English, Japanese, French, German, Spanish, Russian, Italian and Chinese.

- 1 Press  (receiver power) to turn on the unit.
 - 2 Turn on the TV and switch the TV input to display video from the unit.
-  If you turn on the unit for the first time, the message regarding the network setup appears. For now, press RETURN and proceed to Step 3.
- 3 Press **SETUP**.
 - 4 Use the cursor keys to select “System” and press **ENTER**.

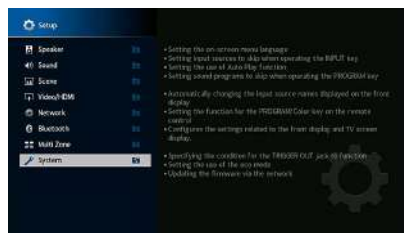

- 5 Use the cursor keys to select “Language” and press **ENTER**.

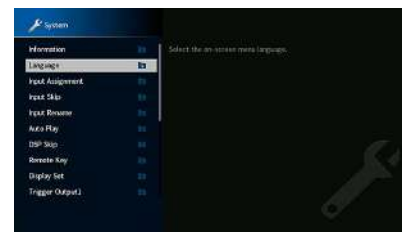

- 6 Use the cursor keys to select the desired language.

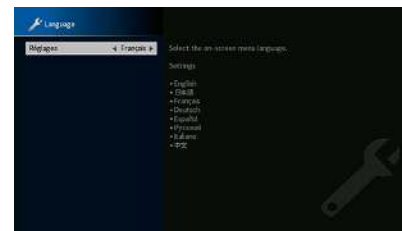

- 7 To exit from the menu, press **SETUP**.



The information on the front display is provided in English only.

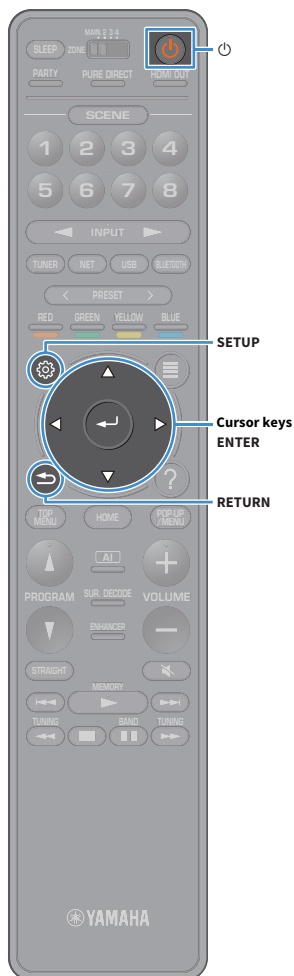

9 Configuring the necessary speaker settings

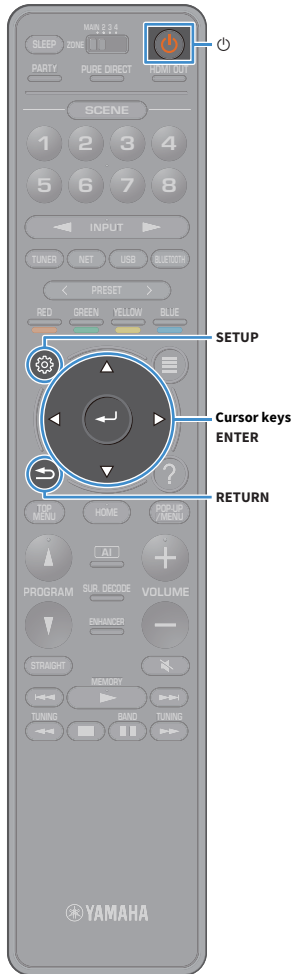

If you use any of the following speaker configurations, follow the procedure below to configure the corresponding speaker settings manually before performing YPAO.

- Using the surround speakers for front 5.1-channel system (Virtual CINEMA FRONT) (p.24)
- Using the presence speakers for Dolby Atmos or DTS:X playback (p.26)

1 Press  (receiver power) to turn on the unit.

2 Turn on the TV and switch the TV input to display video from the unit (HDMI OUT jack).



If you turn on the unit for the first time, the message regarding the network setup appears. For now, press RETURN and proceed to Step 3.

3 Press SETUP.

4 Use the cursor keys to select “Speaker” and press ENTER.

5 Use the cursor keys to select “Configuration” and press ENTER.

6 Configure the corresponding speaker settings.

- When using the surround speakers for front 5.1-channel system (Virtual CINEMA FRONT), select “Configuration” → “Surround” → “Layout” (p.122), then select “Front”.
- When using the presence speakers for Dolby Atmos or DTS:X playback, select “Configuration” → “Front Presence” → “Layout” (p.122), then select your front presence speaker layout. If you are using the rear presence speakers, also select its layout in “Rear Presence”.

7 To exit from the menu, press SETUP.

10 Optimizing the speaker settings automatically (YPAO)



The Yamaha Parametric room Acoustic Optimizer (YPAO) function detects speaker connections, measures the distances from them to your listening position(s), and then automatically optimizes the speaker settings, such as volume balance and acoustic parameters, to suit your room.



The YPAO function of the unit adopts the YPAO-R.S.C. (Reflected Sound Control) technology that enables to create natural sound fields like a room specifically designed for acoustic perfection.



Note the following regarding YPAO measurement.

- Test tones are output at high volume and may surprise or frighten small children.
- Test tone volume cannot be adjusted.
- Keep the room as quiet as possible.
- Stay in a corner of the room behind the listening position so that you do not become an obstacle between speakers and the YPAO microphone.
- Do not connect headphones.

- 1 Press (receiver power) to turn on the unit.
- 2 Turn on the power amplifier.
- 3 Turn on the TV and switch the TV input to display video from the unit.



If you turn on the unit for the first time, the message regarding the network setup appears. For now, press RETURN and proceed to Step 3.

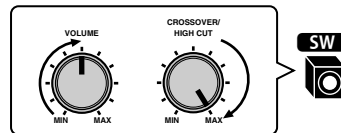

- 5 Place the YPAO microphone at your listening position and connect it to the YPAO MIC jack on the front panel.



Place the YPAO microphone at your listening position (same height as your ears). We recommend the use of a tripod as a microphone stand. You can use the tripod screws to stabilize the microphone.

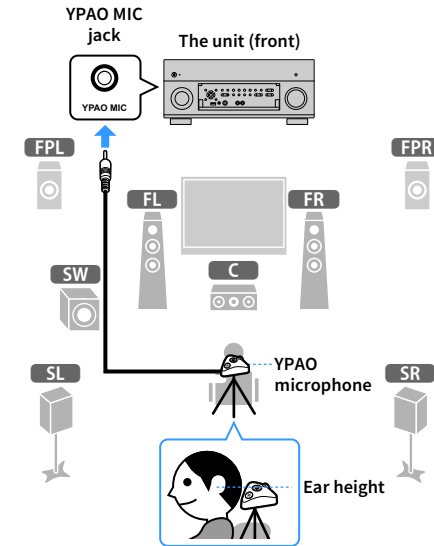

The following screen appears on the TV.

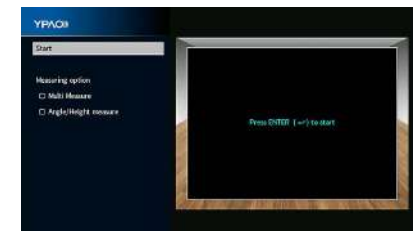

To cancel the operation, disconnect the YPAO microphone before starting the measurement.



6 If desired, select the measuring options.

Use the cursor keys to select “Multi Measure” (p.46) or “Angle/Height Measure” (p.47) and press ENTER.

This completes the preparations. See the following page to start the measurement.

When “Measuring option” is set to “Multi Measure”:

“Measuring at multiple listening positions” (p.50)

When “Measuring option” is not set to “Multi Measure”:

“Measuring at one listening position (single measure)” (p.47)

Multi Measure

Selects multi measure or single measure.

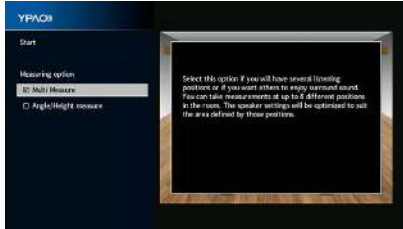

Measuring method

Checked	Select this option if you will have several listening positions or if you want others to enjoy surround sound. You can take measurements at up to 8 different positions in the room. The speaker settings will be optimized to suit the area defined by those positions (multi measure).
Unchecked (default)	Select this option if your listening position will always be fixed. Take the measurements at only one position. The speaker settings will be optimized to suit that position (single measure).



- If you perform the multi measure, the speaker settings will be optimized for you to enjoy surround sound in a wider space.
- If you perform the multi measure, first place the YPAO microphone at the listening position you will be seated most frequently.

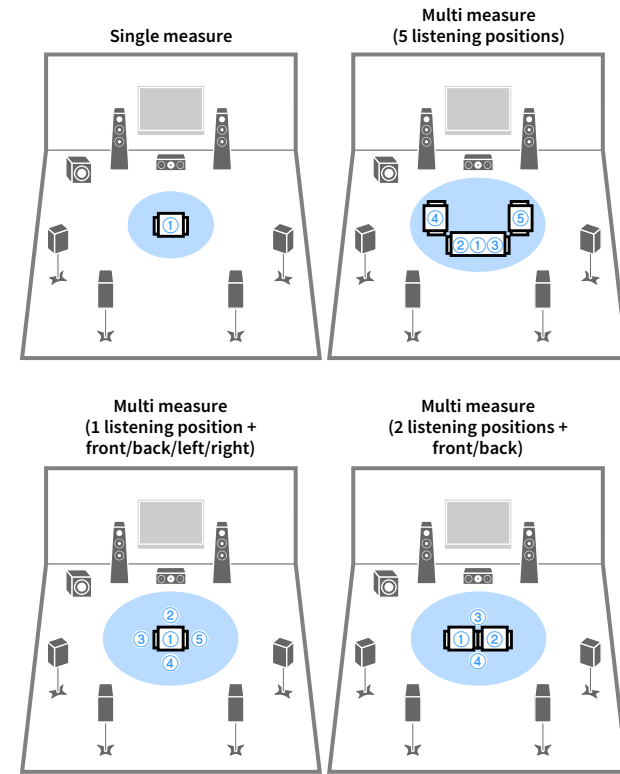

Angle/Height Measure

Enables/disables the angle/height measurement.

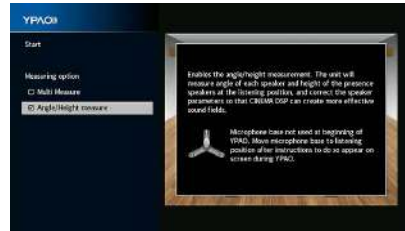

Measuring method

Checked	Enables the angle/height measurement. The unit will measure angle of each speaker and height of the presence speakers at the listening position, and correct the speaker parameters so that CINEMA DSP can create more effective sound fields.
Unchecked (default)	Disables the angle/height measurement.

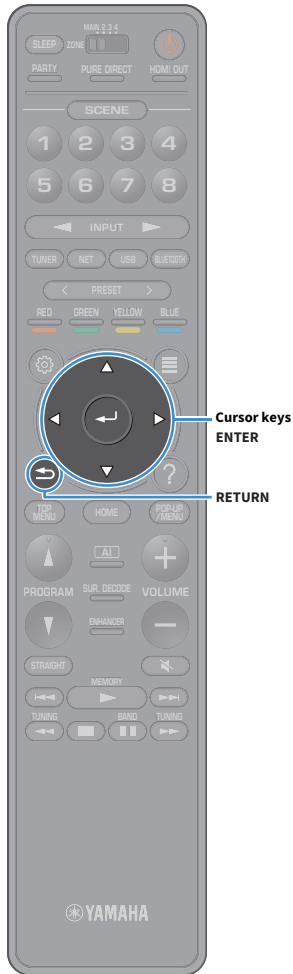

Measuring at one listening position (single measure)

Follow the procedure below to take a measurement when the “Multi Measure” box is unchecked. It takes about 5 minutes to perform the measurement.



- If any error message (such as ERROR 1) or warning message (such as WARNING 1) appears, see “Error messages” (p.54) or “Warning messages” (p.55).
- Do not use the microphone base until the corresponding message appear on the TV.

1 To start the measurement, use the cursor keys to select “Start” and press ENTER.

The measurement will start in 10 seconds. Press ENTER again to start the measurement immediately.



To cancel the measurement temporarily, press RETURN or VOLUME keys.

The following screen appears on the TV when the measurement finishes.

(when angle/height measurement is disabled)

Proceed to Step 3.

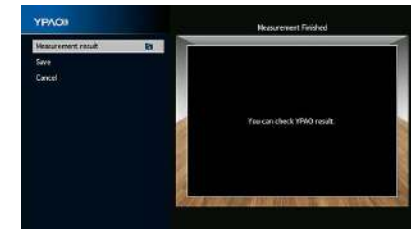



(when angle/height measurement is enabled)

Proceed to Step 2.

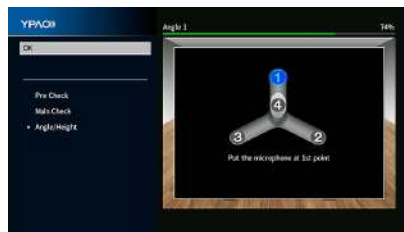

2 Perform the angle/height measurement.

1 Attach the supplied pole to the center of the microphone base.

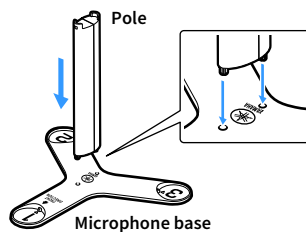

2 Place the microphone base at the listening position and set the YPAO microphone to the position "1".

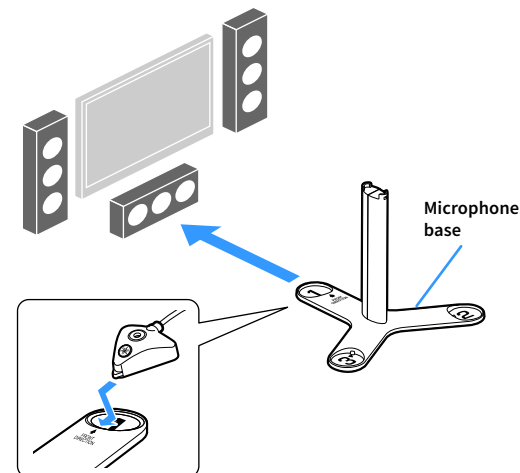

- We recommend using a tripod to place the microphone base at ear height. Use the tripod screws to fix the microphone base in place.
- Do not move the microphone base until the fourth angle measurement finishes.

3 Press ENTER to start the first angle measurement.



4 In the same way, perform the angle measurement for the positions "2" and "3".

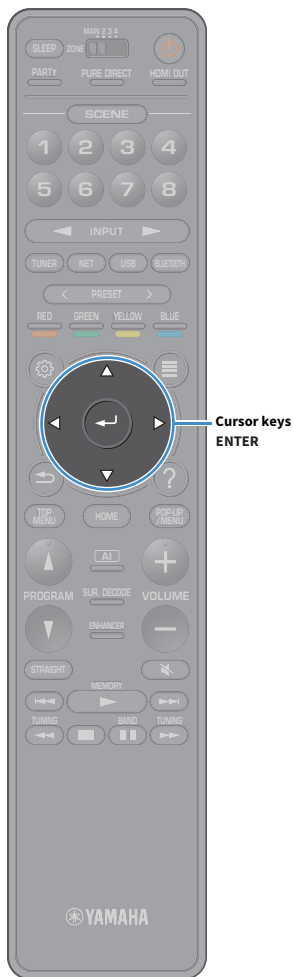

- 5** Set the YPAO microphone at the top of the pole and perform the fourth angle measurement.

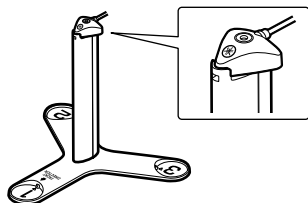

The following screen appears on the TV when the fourth angle measurement finishes.

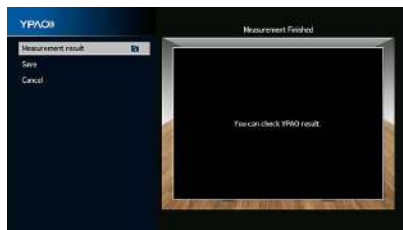

- 3** To check the measurement results, use the cursor keys to select “Measurement result” and press ENTER.

After confirming the result, press RETURN to return to the “Measurement Finished” screen.



For details, see “Checking the measurement results” (p.53).

- 4** To save the measurement results, use the cursor keys to select “Save” and press ENTER.

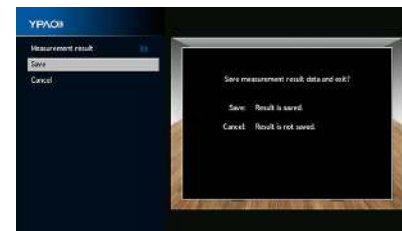

The adjusted speaker settings are applied.



To finish the measurement without saving the result, select “Cancel”.

- 5** Disconnect the YPAO microphone from the unit.

This completes optimization of the speaker settings.

Caution

The YPAO microphone is sensitive to heat, so should not be placed anywhere where it could be exposed to direct sunlight or high temperatures (such as on top of AV equipment).

Measuring at multiple listening positions (multi measure)

Follow the procedure below to take a measurement when the “Multi Measure” box is checked. It takes about 15 minutes to measure 8 listening positions.



- If any error message (such as ERROR 1) or warning message (such as WARNING 1) appears, see “Error messages” (p.54) or “Warning messages” (p.55).
- Do not use the microphone base until the corresponding message appear on the TV.

1 To start the measurement, use the cursor keys to select “Start” and press ENTER.

The measurement will start in 10 seconds. Press ENTER again to start the measurement immediately.



To cancel the measurement temporarily, press RETURN or VOLUME keys.

The following screen appears on the TV when the measurement at the first position finishes.

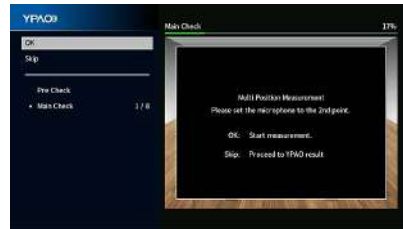

2 Move the YPAO microphone to the next listening position and press ENTER.

Repeat step 2 until measurements at all listening positions (up to 8) have been taken.

3 When the measurements at the positions you want to measure are completed, use the cursor keys to select “Skip” and press ENTER.

When you have taken measurements at 8 listening positions, the following screen appears automatically.

(when angle/height measurement is disabled)

Proceed to Step 5.

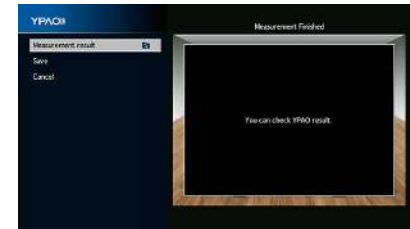

(when angle/height measurement is enabled)

Proceed to Step 4.

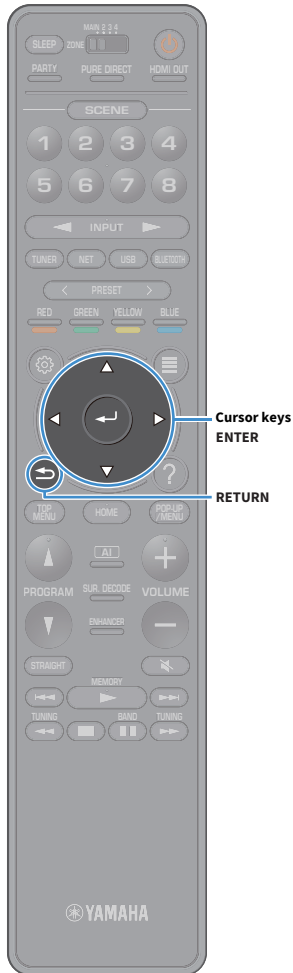
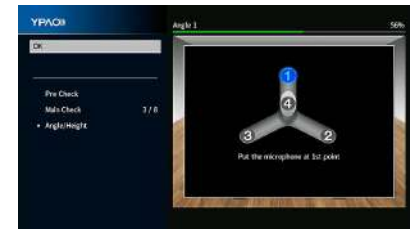



4 Perform the angle/height measurement.

1 Attach the supplied pole to the center of the microphone base.

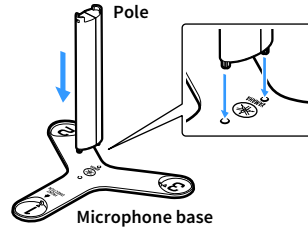

2 Place the microphone base at the listening position you will be seated most frequently and set the YPAO microphone to the position "1".

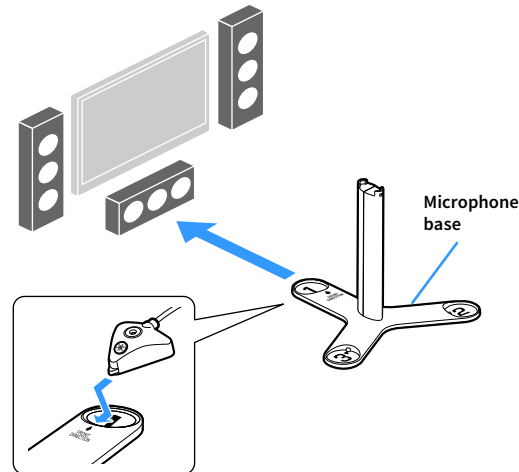

- We recommend using a tripod to place the microphone base at ear height. Use the tripod screws to fix the microphone base in place.
- Do not move the microphone base until the fourth angle measurement finishes.

3 Press ENTER to start the first angle measurement.

The following screen appears on the TV when the first angle measurement finishes.

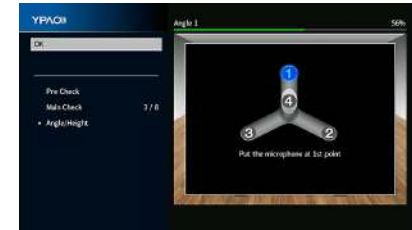

4 In the same way, perform the angle measurement for the positions "2" and "3".

5 Set the YPAO microphone at the top of the pole and perform the fourth angle measurement.

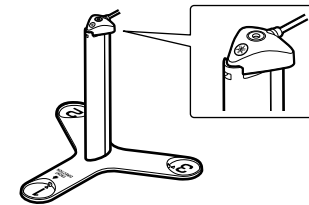

The following screen appears on the TV when the fourth angle measurement finishes.

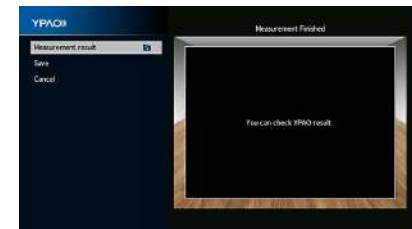

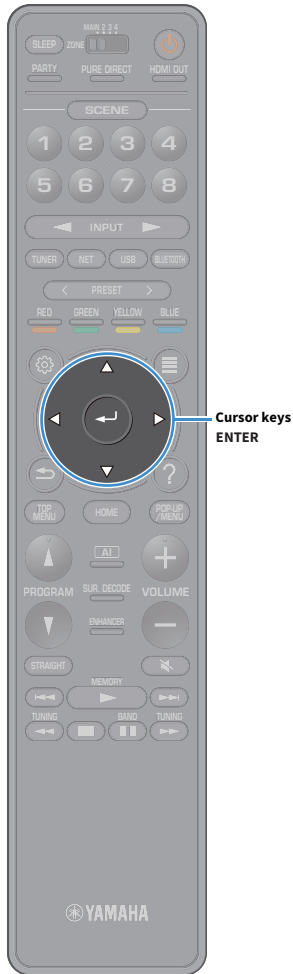

- 5 To check the measurement results, use the cursor keys to select “Measurement result” and press ENTER.



For details, see “Checking the measurement results” (p.53).

- 6 To save the measurement result, use the cursor keys to select “Save” and press ENTER.

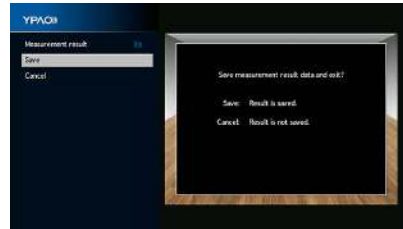

The adjusted speaker settings are applied.



To finish the measurement without saving the result, select “Cancel”.

- 7 Disconnect the YPAO microphone from the unit.

This completes optimization of the speaker settings.

Caution

The YPAO microphone is sensitive to heat, so should not be placed anywhere where it could be exposed to direct sunlight or high temperatures (such as on top of AV equipment).

Checking the measurement results

You can check the YPAO measurement results.

- 1 After the measurement, use the cursor keys to select “Measurement result” and press ENTER.



You can also select “YPAO Result” (p.125) from “Speaker” (p.121) in the “Setup” menu, which displays the previous measurement results.

The following screen appears.

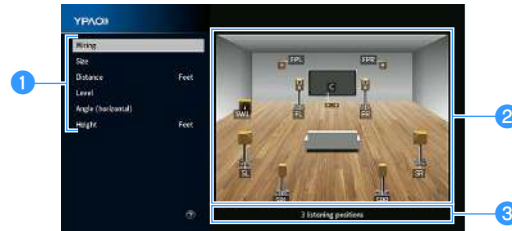

- 1 Measurement result items
- 2 Measurement result details
- 3 The number of measured positions (when multi measure is performed)

- 2 Use the cursor keys to select an item.

Wiring	Polarity of each speaker Reverse: The speaker cable may be connected with the reverse polarity (+/-).
Size	Size of each speaker (cross-over frequency of the subwoofer) Large: The speaker can reproduce low-frequency signals effectively. Small: The speaker cannot reproduce low-frequency signals effectively.
Distance	Distance from the listening position to each speaker
Level	Output level adjustment for each speaker

Angle (horizontal)	Horizontal angle of each speaker at the listening position
Height	Height of the presence speakers above the level of the listening position



- “Angle (horizontal)” and “Height” show the results when angle/height measurement is performed.
- If there are speakers that cannot be detected, check the power amplifier settings and connections.

- 3 To finish checking the results and return to the previous screen, press RETURN.

Reloading the previous YPAO adjustments

When the speaker settings you have configured manually are not suitable, follow the procedure below to discard the manual settings and reload the previous YPAO adjustments.

- 1 In the “Setup” menu, select “Speaker” and then “YPAO Result” (p.125).
- 2 Use the cursor keys to select “Setup Reload” and press ENTER.

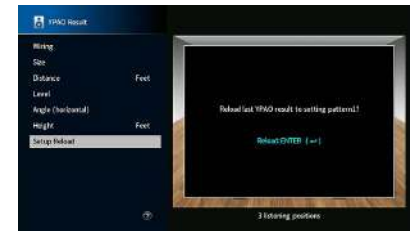

- 3 To exit from the menu, press SETUP.

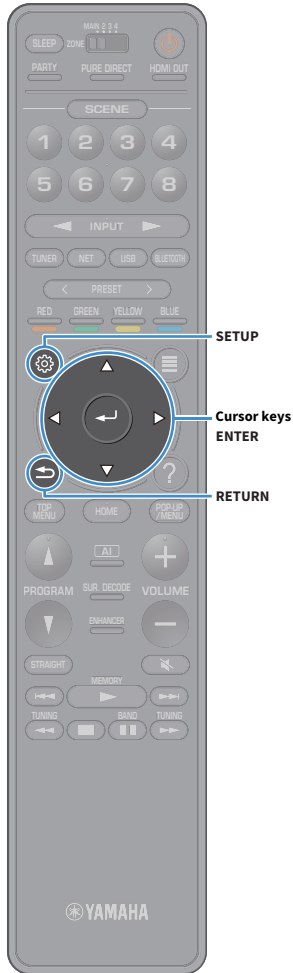

Error messages

If any error message is displayed during the measurement, resolve the problem and perform YPAO again.

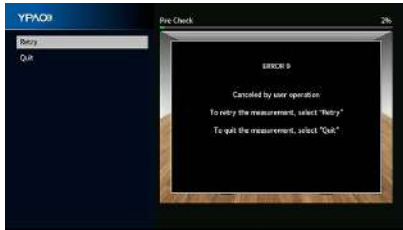

Error message	Remedy
ERROR 1 Front speakers are not detected.	
ERROR 2 One of the surround speakers cannot be detected.	Follow the on-screen instructions to exit YPAO, turn off the unit and power amplifier, and then check the power amplifier connections (to the unit or to the corresponding speakers).
ERROR 3 One of the front presence speakers cannot be detected.	(This error message will be also displayed if you perform YPAO when the power amplifier is turned off.)
ERROR 4 One of the surround back speakers cannot be detected.	
ERROR 5 The noise is too loud.	Keep the room quiet and follow the on-screen instructions to start the measurement again. If you select "Proceed", YPAO takes the measurement again and ignores any noise detected.
ERROR 6 Surround back speakers are connected, but no surround speakers are connected.	Surround speakers need to be connected in order to use surround back speakers. Follow the on-screen instructions to exit YPAO, turn off the unit and power amplifier, and then reconnect the speakers.
ERROR 7 The YPAO microphone has been removed.	Connect the YPAO microphone to the YPAO MIC jack firmly and follow the on-screen instructions to start the measurement again.
ERROR 8 The YPAO microphone cannot detect test tones.	Connect the YPAO microphone to the YPAO MIC jack firmly and follow the on-screen instructions to start the measurement again. If this error occurs repeatedly, contact the nearest authorized Yamaha dealer or service center.
ERROR 9 Canceled by user operation	Follow the on-screen instructions to start the measurement again. To cancel the measurement, select "Quit".
ERROR 10 An internal error has occurred.	Follow the on-screen instructions to exit YPAO, turn off and on the unit. If this error occurs repeatedly, contact the nearest authorized Yamaha dealer or service center.
ERROR 11 One of the rear presence speakers cannot be detected.	Follow the on-screen instructions to exit YPAO, turn off the unit and power amplifier, and then check the power amplifier connections (to the unit or to the rear presence speakers).

Warning messages

If a warning message is displayed after the measurement, you can still save the measurement results by following on-screen instructions.

However, we recommend you perform YPAO again in order to use the unit with the optimal speaker settings.

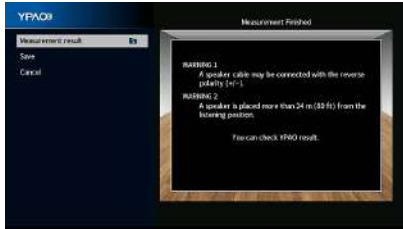

Warning message	Remedy
WARNING 1 A speaker cable may be connected with the reverse polarity (+/-).	Select "Wiring" in "Measurement result" (p.53) and check the cable connections (+/-) of the speaker identified by "Reverse". If the speaker is connected incorrectly: Turn off the unit and power amplifier and then reconnect the speaker cable. If the speaker is connected correctly: Depending on the type of speakers or room environment, this message may appear even if the speakers are connected correctly. In this case, you can ignore the message.
WARNING 2 A speaker is placed more than 24 m (80 ft) from the listening position.	Select "Distance" in "Measurement result" (p.53) and move the speaker identified by ">24.00m (>80.0ft)" within 24 m (80 ft) of the listening position. Turn off the unit and power amplifier, and then install the corresponding speaker within 24 m of the listening position.
WARNING 3 There are significant volume differences between the speakers.	Select "Level" in "Measurement result" (p.53) and check the speaker identified by "Over ±10.0dB", then check the usage environment and cable connections (+/-) of each speaker, and the volume of the subwoofer. If there is a problem, exit YPAO, turn off the unit and power amplifier, and then correct the connections and arrangement of the speakers. We recommend using the same speakers or speakers with specifications that are as similar as possible.

11 Connecting to a network device wirelessly

Connect the unit to a wireless router (access point) or a mobile device by establishing a wireless connection.

Connecting with a wireless router (access point)

Connect the unit to a wireless router (access point).

You can enjoy Internet radio, AirPlay, or music files stored on media servers (PC/NAS) on the unit.

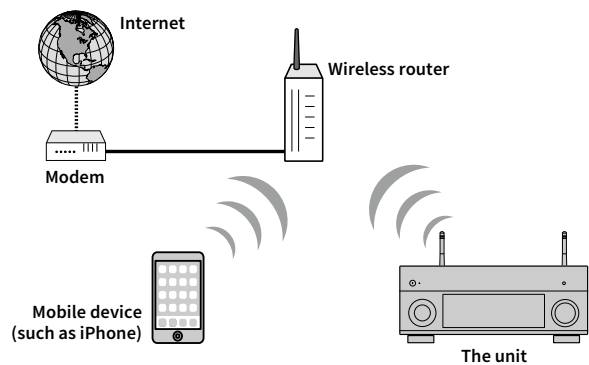

For details on connection, see “Connecting the unit to a wireless network” (p.57).

Connecting the unit to a wireless network

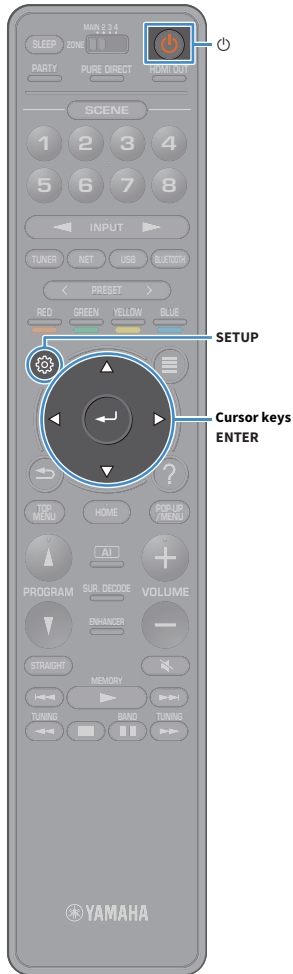

There are several methods to connect the unit to a wireless network. Select a connection method according to your environment.

- Using MusicCast CONTROLLER (p.62)
- Sharing the iOS device setting (p.57)
- Using the WPS push button configuration (p.58)
- Using other connection methods (p.59)

Sharing the iOS device setting

You can easily set up a wireless connection by applying the connection settings on iOS devices (iPhone/iPad/iPod touch).

Before proceeding, confirm that your iOS device is connected to a wireless router.



If you set up a wireless connection with this method, the following settings will be initialized.

- Network settings
- Bluetooth settings
- USB and network items registered as shortcuts
- Internet radio stations register to “Favorites”
- Account information for the network services



- You need iOS device with iOS 7 or later. (The following procedure is a setup example for iOS 8.)
- This configuration does not work if the security method of your wireless router (access point) is WEP. In this case, use other connection method.

- 1 Press (receiver power) to turn on the unit.
- 2 Turn on the TV and switch the TV input to display video from the unit (HDMI OUT jack).



Operations with TV screen are available only when your TV is connected to the unit via HDMI.

- 3 Press SETUP.

- 4 Use the cursor keys to select “Network”.
- 5 Use the cursor keys to select “Network Connection” and press ENTER.
- 6 Use the cursor keys and ENTER to check “Wireless (Wi-Fi)” and select “OK”.

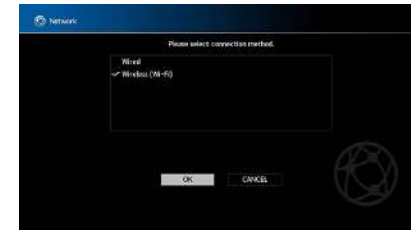

The checkmark indicates the current setting.

- 7 Use the cursor keys and ENTER to check “Share Wi-Fi Settings (iOS)” and select “NEXT”.

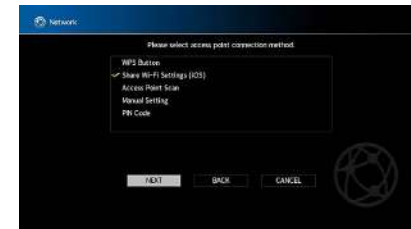

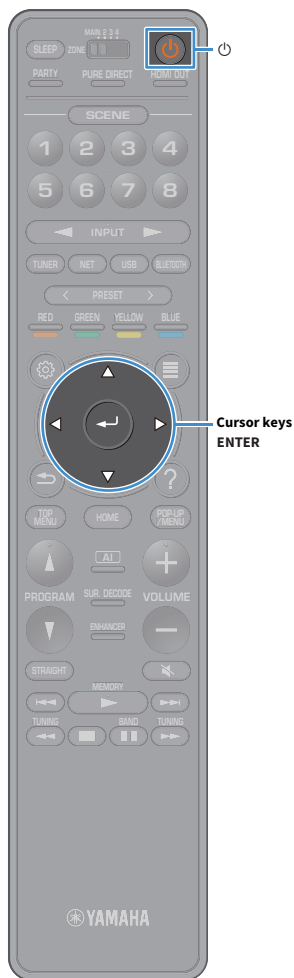

- 8** After checking the on-screen message, use the cursor keys and ENTER to select “NEXT”.



- 9** On the iOS device, select the unit as the AirPlay speaker in the Wi-Fi screen.



- 10** Check the network currently selected and tap “Next”.

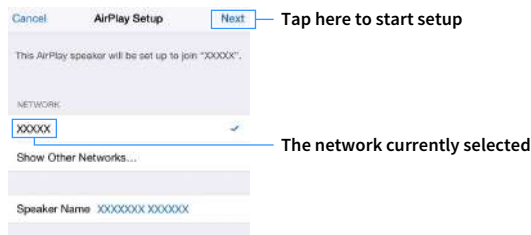

When the sharing process finishes, the unit is automatically connected to the selected network (access point).

Using the WPS push button configuration

You can easily set up a wireless connection with one push of the WPS button.



This configuration does not work if the security method of your wireless router (access point) is WEP. In this case, use other connection method.

- 1** Press  (receiver power) to turn on the unit.
- 2** Hold down INFO (WPS) on the front panel for 3 seconds.
“Press WPS button on Access Point” appears on the front display.
- 3** Push the WPS button on the wireless router (access point).

When the connection process finishes, “Completed” appears on the front display.

If “Not connected” appears, repeat from Step 1 or try another connection method.



About WPS

WPS (Wi-Fi Protected Setup) is a standard established by the Wi-Fi Alliance, which allows easy establishment of a wireless home network.



■ Using other connection methods

If your wireless router (access point) does not support WPS push button configuration method, follow the procedure below to configure the wireless network settings.

- 1 Press  (receiver power) to turn on the unit.
 - 2 Turn on the TV and switch the TV input to display video from the unit (HDMI OUT jack).
-  Operations with TV screen are available only when your TV is connected to the unit via HDMI.
- 3 Press **SETUP**.
 - 4 Use the cursor keys to select “Network” and press **ENTER**.
 - 5 Use the cursor keys to select “Network Connection” and press **ENTER**.
 - 6 Use the cursor keys and **ENTER** to check “Wireless (Wi-Fi)” and select “OK”.

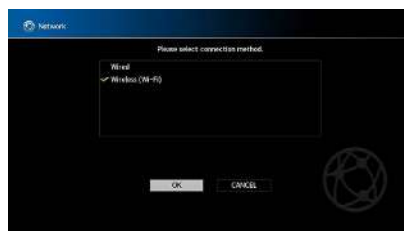

The checkmark indicates the current setting.

- 7 Use the cursor keys and **ENTER** to select the desired connection method and select “NEXT”.

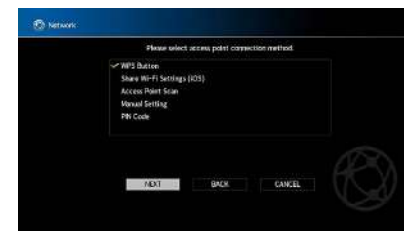

The following connection methods are available.

WPS Button	You can set up a wireless connection with the WPS button while viewing the TV screen. Follow the instructions displayed on the TV screen.
Share Wi-Fi Settings (iOS)	See “Sharing the iOS device setting” (p.57).
Access Point Scan	You can set up a wireless connection by searching for an access point. For details on settings, see “Searching for an access point” (p.60).
Manual Setting	You can set up a wireless connection by entering the required information (such as SSID) manually. For details on settings, see “Setting up the wireless connection manually” (p.60).
PIN Code	You can set up a wireless connection by entering the unit’s PIN code into the wireless router (access point). The method is available if the wireless router (access point) supports the WPS PIN code method. For details on settings, see “Using the PIN code” (p.61).



Searching for an access point

If you select “Access Point Scan” as the connection method, the unit starts searching for access points. After a while, the list of available access points appears on the TV screen.

- 1 Use the cursor keys and ENTER to check the desired access point and select “NEXT”.

The wireless connection setting screen appears on the TV.

- 2 Use the cursor keys and ENTER to enter the security key and select “NEXT”.



- 3 Use the cursor keys to select “CONNECT” and press ENTER to start the connection process.

When the connection process finishes, “Completed” appears on the TV screen.

If “Not connected” appears, repeat from Step 1 or try another connection method.

- 4 To exit from the menu, press SETUP.

Setting up the wireless connection manually

If you select “Manual Setting” as the connection method, the wireless connection setting screen appears on the TV.

You need to setup the SSID (network name), encryption method and security key for your network.

- 1 Use the cursor keys and ENTER to enter the SSID of the access point and select “NEXT”.



- 2 Use the cursor keys and ENTER to check the security method of the access point and select “NEXT”.

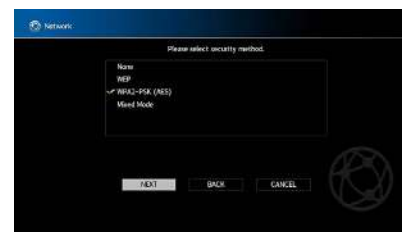

Settings

None, WEP, WPA2-PSK (AES), Mixed Mode



3 Use the cursor keys and ENTER to enter the security key and select “NEXT”.

If you select “None” in Step 2, this setting is not available. Proceed to Step 4.

If you select “WEP”, enter either 5 or 13 character string, or 10 or 26 hexadecimal digits.

If you select other method, enter either 8 to 63 character string, or 64 hexadecimal digits.



4 Use the cursor keys to select “CONNECT” and press ENTER to start the connection process.

When the connection process finishes, “Completed” appears on the TV screen.

If “Not connected” appears, check that all the information is entered correctly, and repeat from Step 1.

5 To exit from the menu, press SETUP.

Using the PIN code

If you select “PIN Code” as the connection method, the list of available access points appears on the TV screen.

1 Use the cursor keys and ENTER to check the desired access point and select “NEXT”.

The PIN code of the unit appears on the TV screen.

2 Enter the unit’s PIN code into the wireless router (access point).

For details on settings, refer to the instruction manual of the wireless router (access point).

3 Use the cursor keys to select “CONNECT” and press ENTER to start the connection process.

When the connection process finishes, “Completed” appears on the TV screen.

If “Not connected” appears, repeat from Step 1 or try another connection method.

4 To exit from the menu, press SETUP.

12 Connecting to the MusicCast network



MusicCast is a brand new wireless musical solution from Yamaha, allowing you to share music among all of your rooms with a variety of devices. You can enjoy music from your smartphone, PC, NAS drive and music streaming service anywhere in your house with one easy-to-use application. For more details and a lineup of MusicCast compatible products, visit the Yamaha website.

- Seamlessly control all MusicCast compatible devices with the dedicated application “MusicCast CONTROLLER”.
- Link a MusicCast compatible device to another device in a different room and play them back simultaneously.
- Play back music from music streaming services. (The compatible music streaming services may differ depending on your region and product.)

MusicCast CONTROLLER



To use the network features on the MusicCast compatible device, you need the dedicated application “MusicCast CONTROLLER” for the operation. Search for the free application “MusicCast CONTROLLER” on the App Store or Google Play and install it to your device.

Adding the unit to the MusicCast network

Follow the procedure below to add the unit to the MusicCast network. You can also configure the unit’s wireless settings at once.



- The SSID and security key for your network will be needed.
- If your router supports multiple SSID’s (network names), connect the mobile device to the first access point (“SSID 1”, etc.).

1 Press  (receiver power) to turn on the unit.

2 Tap the “MusicCast CONTROLLER” application icon on your mobile device and tap “Setup”.



If you have already connected other MusicCast compatible devices to the network, tap “Settings” and then “Add New Device”.

3 Operate the “MusicCast CONTROLLER” application following the on screen instructions, then hold down **CONNECT** on the front panel of the unit for 5 seconds.

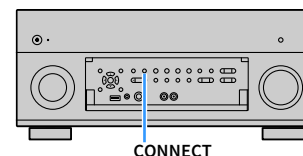

4 Operate the “MusicCast CONTROLLER” application following the onscreen instructions to set up the network.

5 Operate the “MusicCast CONTROLLER” application to playback.



- AirPlay and DSD audio cannot be delivered.
- When Pure Direct is enabled, input sources other than the network sources and USB cannot be delivered.
- If you configure the unit’s wireless settings with this method, the Wireless LAN indicator of the front display lights up when the unit is connecting to a network (even if a wired connection is used).
- You can interlock the power of MusicCast devices with the power of the unit (MusicCast master). For details, see “MusicCast Link Power Interlock” (p.138) in the “Setup” menu.

PLAYBACK



Basic playback procedure

- 1 Turn on the external devices (such as a TV or BD/DVD player) connected to the unit.
- 2 Use the input selection keys to select an input source.
- 3 Start playback on the external device or select a radio station.

Refer to the instruction manual for the external device.

For details on the following operations, see the corresponding pages.

- Listening to FM/AM radio (except Australia, U.K., Europe, Middle East and Russia models) (p.72)
- Listening to DAB radio (Australia, U.K., Europe, Middle East and Russia models only) (p.75)
- Listening to FM radio (Australia, U.K., Europe, Middle East and Russia models only) (p.81)
- Playing back music via Bluetooth (p.85)
- Playing back music stored on a USB storage device (p.86)
- Playing back music stored on media servers (PCs/NAS) (p.90)
- Listening to Internet radio (p.94)
- Playing back iTunes/iPod music with AirPlay (p.97)

- 4 Press VOLUME to adjust the volume.



- To mute the audio output, press MUTE. Press MUTE again to unmute.
- To adjust the treble/bass settings, use the “Option” menu.

Selecting an HDMI output jack

- 1 Press HDMI OUT to select an HDMI OUT jack.

Each time you press the key, the HDMI OUT jack to be used for signal output changes.



OUT 1+2	Outputs the same signal at both the HDMI OUT 1 and HDMI OUT 2 jacks.
OUT 1	Output the signals at the selected HDMI OUT jack.
OUT 2	
Off	Does not output the signals at the HDMI OUT jacks.



- You can also select an HDMI output jack by selecting a scene (p.64).
- When “OUT 1+2” is selected, the unit outputs video signals at the highest resolution supported by both TVs (or projectors) connected to the unit. (For example, if you have connected a 1080p TV to the HDMI OUT 1 jack and a 720p TV to the HDMI OUT 2 jack, the unit outputs 720p video signals.)
- When the MAIN/ZONE switch on the remote control is set to “ZONE2” or “ZONE4”, pressing the HDMI OUT key can enable (OUT 3) or disable (OFF) the HDMI OUT3 jack output.

Selecting the input source and favorite settings with one touch (SCENE)



The SCENE function allows you to select the assigned input source, sound program, HDMI output and various settings with just one touch. You can use up to 8 scenes to register your favorite settings and switch them depending on a playback source.

- 1 Press numbered key (1 to 8), and then the input source and settings registered to the corresponding scene are directly selected. The unit turns on automatically when it is in standby mode.

Alternatively, you can also select a registered scene by pressing SCENE repeatedly.

The SCENE name appears on the front display and on the TV.

- 2 To select a desired SCENE name, press ENTER.



- To cancel the operation of selecting a registered scene, press RETURN.
- The operation is canceled automatically when you have not operated the unit for the 30 seconds.

By default, the following input settings are registered for each scene.

Main Zone, Zone2 and Zone3

SCENE	1	2	3	4
Input	AV1	TUNER	AUDIO2	NET RADIO
SCENE	5	6	7	8
Input	AV2	AV3	AUDIO 1	SERVER

Zone4

SCENE	1	2	3	4
Input	AV1	AV2	AV3	AV4
SCENE	5	6	7	8
Input	AV5	AV6	AV7	AV1



- You can check the detailed settings of each scene from the “Scene Setting” screen (p.131) in the “Setup” menu.
- You can also register and recall SCENE 1-4 with the SCENE key on the unit’s front panel.

Registering a scene

- 1 Set the unit to the condition (such as input source and sound program) that you want to assign to a scene.
- 2 Hold down the desired numbered key (1-8) until “SET Complete (Setting Complete)” appears on the front display and on the TV.



- You can configure more detailed scene assignments in “Scene Setting” in the “Setup” menu. For details, see “Scene Setting” (p.131).
- You can change the SCENE name displayed on the front display or on the TV. For details, see “Scene Rename” (p.132).

Selecting the sound mode

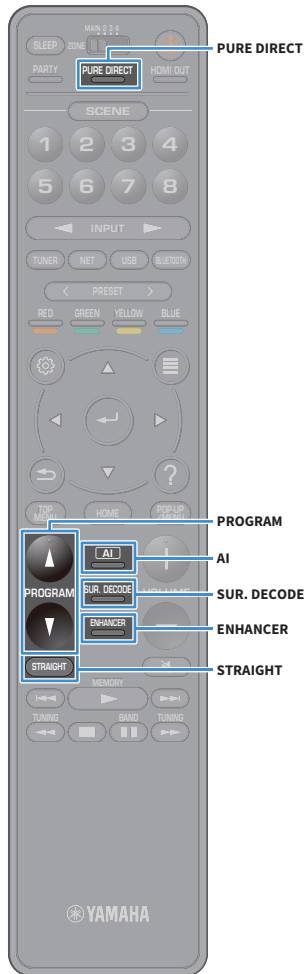

The unit is equipped with a variety of sound programs and surround decoders that allow you to enjoy playback sources with your favorite sound mode (such as sound field effect or stereo playback).

Enabling SURROUND:AI.

- Press AI.

This mode lets you enjoy the optimum surround effect according to AI analysis as well as a compelling sense of realism (p.66).

Selecting a sound program suitable for movies and music

- Press PROGRAM repeatedly.

This mode lets you enjoy sound field effects optimized for viewing video sources, such as movies and games, as well as for listening to music sources or for stereo playback.

Selecting a surround decoder

- Press SUR. DECODE repeatedly.

This mode lets you enjoy unprocessed multichannel playback from 2-channel sources (p.70).

Switching to the straight decode mode

- Press STRAIGHT.

This mode lets you enjoy unprocessed sounds in original channels (p.70).

Enabling Pure Direct

- Press PURE DIRECT.

This mode lets you enjoy pure high fidelity sound by reducing the electrical noise from other circuitry (p.71).

Enabling Compressed Music Enhancer

- Press ENHANCER.

This mode lets you enjoy compressed music with additional depth and breadth (p.71).



- You can change the settings of the surround programs and surround decoders in the “Sound” menu (p.125).
- The sound mode can be applied separately to each input source.
- You can check which channels are currently outputting sound by looking at the Channel indicators on the unit’s front panel (p.15) or at the “Information” screen in the “Sound” menu (p.125).
- A sound program or surround decoder cannot be used with the signal from an analog multichannel input.

Precaution for enjoying Dolby Atmos®

- Dolby Atmos contents are decoded as Dolby TrueHD or Dolby Digital Plus in the following situations. (Dolby Atmos PCM format is always decoded as Dolby Atmos.)
 - Neither surround back nor presence speakers are used.
 - Headphones are used (2-channel playback).
- When the Dolby Atmos decoder is working, virtual surround processing (such as Virtual CINEMA FRONT) (p.69) does not work.

Precaution for enjoying DTS:X™

- When DTS:X contents are played back, you can adjust the volume of dialogue sounds in “DTS Dialogue Control” (p.111) in the “Option” menu.
- When the DTS:X decoder is working, virtual surround processing (such as Virtual CINEMA FRONT) (p.69) does not work.

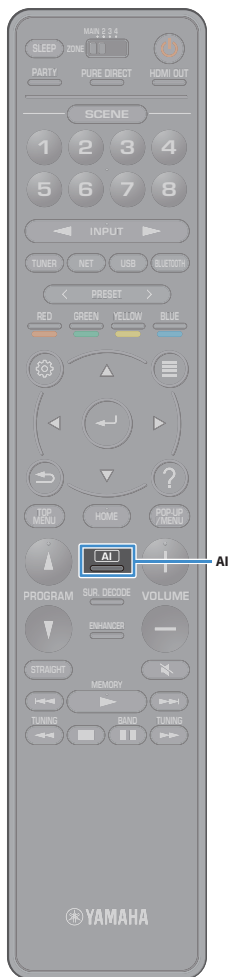

Playing back with surround effects optimized for the scene (SURROUND:AI)

With SURROUND:AI, the AI incorporated in the DSP creates the optimal surround effect for the scene of the content.

Scenes are instantaneously analyzed with a focus on sound elements such as “dialogue”, “background music”, “ambient sounds” and “sound effects” as well as optimized in real time to create a compelling sense of realism.

1 Press AI.

Each time you press the key, SURROUND:AI is enabled or disabled.



- When PURE DIRECT is enabled, SURROUND:AI is not available.
- When SURROUND:AI is enabled, the straight decode mode, PROGRAM key and the surround decoders are not available.
- When “MULTI CH” is selected as the input source, SURROUND:AI is not available.

Enjoying stereoscopic sound fields (CINEMA DSP HD³)



The unit is equipped with a variety of sound programs that utilize Yamaha’s original DSP technology (CINEMA DSP HD³). It allows you to easily create sound fields like actual movie theaters or concert halls in your room and enjoy natural stereoscopic sound fields.

Sound program category



Sound program

“CINEMA DSP HD³” lights up



- The unit creates front Virtual Presence Speaker (VPS) using the front, center, and surround speakers to produce 3-dimensional sound fields even when no front presence speakers are connected. However, we recommend using front presence speakers in order to experience the full effect of the sound fields (and rear presence speakers for further spatial sounds) (p.130).
- The unit creates rear Virtual Presence Speaker (VPS) using the front, center, and surround speakers to produce natural 3-dimensional sound fields when front presence speakers are connected but no rear presence speakers (p.130).
- If a multichannel source (6.1 channels or more) is input when no surround back speakers are connected, the unit creates Virtual Surround Back Speaker (VSBS) using the surround speakers to add a sense of depth to the rear sound field (p.130).
- When VPS or VSBS is working, “VIRTUAL” lights up in the front display.
- When “MULTI CH” is selected as the input source, CINEMA DSP is not available.

Sound programs suitable for movies (MOVIE)

The following sound programs are optimized for viewing video sources, such as movies, TV programs, and games.

MOVIE THEATER

Standard	This program creates a sound field that emphasizes the surround feeling without disturbing the original acoustic positioning of multichannel audio. Its design is based on the concept of the ideal movie theater, in which the audience is surrounded by beautiful reverberations from the left, right, and rear.
Spectacle	This program delivers the scale and grandeur of spectacular movie productions. It delivers an expansive sound space to match the cinemascope wide-screen, and boasts a broad dynamic range, providing everything from small delicate sounds to powerful loud booms.
Sci-Fi	This program clearly reproduces the finely elaborated sound design of the latest Sci-Fi and SFX movies. You can enjoy a variety of cinematographically created virtual spaces reproduced with clear separation between dialogue, sound effects, and background music.
Adventure	This program is ideal for reproducing the sound design of action and adventure movies precisely. The sound field restrains reverberations, but puts emphasis on reproducing a sensation of expansiveness on both sides, powerful space expanded widely to the left and right. The restrained depth creates a clear and powerful space, while also maintaining the articulation of the sounds and the separation of the channels.
Drama	This program features stable reverberations that match a wide range of movie genres, from serious dramas to musicals and comedies. The reverberations are modest, but suitably stereophonic. The sound effects and background music are reproduced with a gentle echo that does not impinge on the articulation of the dialogue. You'll never get tired listening for long periods.
Mono Movie	This program reproduces monaural video sources, such as classic movies, in an atmosphere of a good old movie theater. The program creates a pleasant space with depth, by adding breadth and the appropriate reverberation to the original audio.
Enhanced	This program creates a sound field that emphasizes the dynamic sound transition of 3D object audio. Its design is based on the concept of a movie theater with multi-top speakers, in which the audience is overwhelmed by the natural and powerful sound effects.

ENTERTAINMENT

Sports	This program allows listeners to enjoy the rich vividness of sport broadcasts and light entertainment programs. In sports broadcasts, the commentators' voices are positioned clearly at the center, while the atmosphere inside the stadium is realistically conveyed by the peripheral delivery of the sounds of the fans in a suitable space.
Action Game	This program is suitable for action games, such as car racing and fighting games. The reality of, and emphasis on, various effects makes the player feel like they are right in the middle of the action, allowing for greater concentration. Use this program in combination with Compressed Music Enhancer for a more dynamic and strong sound field.
Roleplaying Game	This program is suitable for role-playing and adventure games. This program adds depth to the sound field for natural and realistic reproduction of background music, special effects, and dialogue from a wide variety of scenes. Use this program in combination with Compressed Music Enhancer for a clearer and more spatial sound field.
Music Video	This program allows you to enjoy videos of pop, rock, and jazz concerts, as if you were there yourself. Immerse yourself in the hot concert atmosphere thanks to the vividness of the singers and solos on stage, a presence sound field that emphasizes the beat of rhythm instruments, and a surround sound field that reproduces the space of a big live hall.
Recital/Opera	This program controls the amount of reverberations at an optimum level and emphasizes the depth and clarity of human voices to offer the reverberations of an orchestra box in front the listener at the same time as providing the acoustic positioning and feeling of presence on the stage. The surround sound field is relatively moderate, but the data for concert hall effects are used to represent the inherent beauty of music. The listener will not be fatigued even after long hours of opera entertainment.
Pavilion	This program reproduces vocals clearly, letting you feel the spaciousness of a pavilion. Reverberation, which is somewhat delayed, reproduces the live acoustics unique to a pavilion, and helps to make concert scenes more exciting.
Disco	This program recreates the acoustic environment of a lively disco in the heart of a big city. The sound is dense and highly concentrated. It is also characterized by high-energy, "immediate" sound.

■ Sound programs suitable for music/stereo playback (MUSIC)

The following sound programs are optimized for listening to music sources.

You can also select stereo playback.

CLASSICAL

Hall in Munich A	This sound field simulates a concert hall with approximately 2,500 seats in Munich, using stylish wood for the interior finishing as normal standards for European concert halls. Fine, beautiful reverberations spread richly, creating a calming atmosphere. The listener's virtual seat is at the center left of the arena.
Hall in Munich B	This hall is frequently used for recording orchestral music, and is a shoe-box type concert hall with around 1,300 seats. The hall is constructed from marble, resulting in relatively flat resonance. Further, the high ceiling causes sound to reverberate for longer than usual.
Hall in Frankfurt	This is a large shoe-box type concert hall with around 2,400 seats located in Frankfurt. This hall has a very solid, powerful sound. The listener's virtual seat is in the center-right section on the first floor.
Hall in Stuttgart	This is a large asymmetrical concert hall with around 2,000 seats located in downtown Stuttgart. Sound reflected off the concrete wall located to the left of listeners has a powerful presence.
Hall in Vienna	This program simulates a 1,700-seat, middle-sized concert hall with a shoebox shape that is traditional in Vienna. Pillars and ornate carvings create extremely complex reverberations from all around the audience, producing a very full, rich sound.
Hall in Amsterdam	The large, shoe box shaped hall seats about 2,200 around the circle stage. Reflections are rich and pleasing while the sound travels freely.
Hall in USA A	This is a large 2,600 seat concert hall in the United States which features a fairly traditional European design. The interior is relatively simple, in the American style. The middle and high frequencies are richly and beautifully reinforced.
Hall in USA B	This spacious arch-shaped hall has a dome ceiling and can seat 2,600. The ample resonance apparent in the sound is a feature brought about by longer than average period of reverberation. In addition to this, the reflector suspended above the stage allows listeners to experience rich sound from the direction of the stage.
Church in Tokyo	The acoustic environment of an ordinary church with moderate reverberations. The reverberation lasts 2.5 seconds. This is ideal for reproducing church organ and choral music.
Church in Freiburg	Located in the south of Germany, this grand, stone-built church has a pointed tower at 120 meters in height. Its long and narrow shape and the high ceiling enable the elongated reverberation time and limited initial reflection time. Thus, the rich reverberation rather than the sound itself reproduces the atmosphere of the church.

Church in Royaumont

This program features the sound field created by the refectory (dining hall) of a beautiful medieval Gothic monastery located in Royaumont on the outskirts of Paris.

Chamber

This program creates a relatively wide space with a high ceiling, like an audience hall in a palace. It offers pleasant reverberations that are suitable for courtly music and chamber music.

LIVE/CLUB

Village Gate

This is the sound field at a jazz club that was in New York. It is in a basement and has a relatively spacious floor area. The listener's virtual seat is at the center left of the hall.

Village Vanguard

The Jazz club is on 7th Avenue, New York. This small club with the low ceiling makes the powerful reflections converge toward the stage located in the center.

Warehouse Loft

The warehouse resembles some lofts in Soho. Sound reflects off the concrete walls clearly with a lot of energy.

Cellar Club

This program simulates an intimate concert venue with a low ceiling and homey atmosphere. A realistic, live sound field delivers powerful sounds that make you feel as if you are sitting in the front row in front of a small stage.

The Roxy Theatre

This program creates the sound field of a 460-seat rock music concert venue in Los Angeles. The listener's virtual seat is at the center left of the hall.

The Bottom Line

This program creates the sound field at stage front in The Bottom Line, a famous New York jazz club once. The floor can seat 300 people to the left and right in a sound field offering real and vibrant sound.

Arena

This program gives you long delays between direct sounds and effect sounds, with the extraordinarily spacious feel of a large arena.

STEREO

2ch Stereo

Use this program to mix down multichannel sources to 2 channels. When multichannel signals are input, they are down mixed to 2 channels and output from the front speakers (this program does not utilize CINEMA DSP).

11ch Stereo

Use this program to output sound from all speakers. When you play back multichannel sources, the unit mixes down the source to 2 channels, and then outputs the sound from all speakers. This program creates a larger sound field and is ideal for background music at parties.



CINEMA DSP HD³ (p.66) and Virtual CINEMA DSP (p.69) do not work when "2ch Stereo" or "11ch Stereo" is selected.

■ Enjoying sound field effects without surround speakers (Virtual CINEMA DSP)

If you select one of the sound programs (except 2ch Stereo and 11ch Stereo) when no surround speakers are connected, the unit utilizes Yamaha's original virtual surround technology to reproduce up to 7-channel surround sound and enable you to enjoy the well-oriented sound field only with the front-side speakers. We recommend using presence speakers in order to enjoy more effective stereoscopic sound field.



When Virtual CINEMA DSP is working, "VIRTUAL" lights up in the front display.

■ Enjoying surround sound with 5 speakers placed in front (Virtual CINEMA FRONT)

If you have surround speakers but there is no space to place them in the rear of your room, you can place them in the front (p.24) and enjoy multichannel surround sound using Virtual CINEMA FRONT.

When "Layout (Surround)" (p.122) in the "Setup" menu is set to "Front", the unit creates the virtual surround speakers in the rear side to allow you to enjoy multichannel surround sound with the 5 speakers placed in the front.



When Virtual CINEMA FRONT is working, "VIRTUAL" lights up in the front display.

■ Enjoying surround sound with headphones (SILENT CINEMA)

SILENT™ CINEMA

You can enjoy surround or sound field effects, like a multichannel speaker system, with stereo headphones by connecting the headphones to the PHONES jack and selecting a sound program or a surround decoder.

Enjoying unprocessed playback

You can play back input sources without any sound field effect processing.

■ Playing back in original channels (straight decode)

When the straight decode mode is enabled, the unit produces stereo sound from the front speakers for 2-channel sources such as CDs, and produces unprocessed multichannel sounds for multichannel sources.

1 Press STRAIGHT.

Each time you press the key, the straight decode mode is enabled or disabled.



- To enable 6.1/7.1-channel playback from 5.1-channel sources when surround back speakers are used, select a surround decoder (p.70).
- If “Layout (Surround)” (p.122) in the “Setup” menu is set to “Front”, Virtual CINEMA FRONT (p.69) works when multichannel source is played back.

■ Playing back in extended multichannel (surround decoder)

The surround decoder enables unprocessed multichannel playback from 2-channel or multichannel sources.



- We recommend Dolby Surround while network streaming is Dolby contents.
- Speakers that produce sounds will change depending on your speaker system and the selected decode type (p.126).
- For details on each decoder, see “Glossary” (p.163).
- When “MULTI CH” is selected as the input source, Surround Decoder is not available.

1 Press SUR. DECODE to select a surround decoder.

Each time you press the key, the surround decoder changes.



Auto

Uses the decoder automatically selected by input source. The DTS Neural:X decoder is selected for DTS sources and the Dolby Surround decoder is selected for other sources.

Dolby Dsur

Dolby Surround decoder. Expands the sound using a method optimized for the layout of the installed speakers. It produces the extended surround sound optimized for your speaker system. A real acoustic space (including overhead) will be created especially when objectbased audio (such as Dolby Atmos content) is played.

Neural:X

DTS Neural:X decoder. Expands the sound using a method optimized for the layout of the installed speakers. It produces the extended surround sound optimized for your speaker system. A real acoustic space (including overhead) will be created especially when objectbased audio (such as DTS:X content) is played.

Neo:6 Cinema

Uses the DTS Neo:6 decoder (or DTS-ES Matrix decoder) suitable for movies. Sounds will be output from the surround/surround back speakers.

Neo:6 Music

Uses the DTS Neo:6 decoder (or DTS-ES Matrix decoder) suitable for music. Sounds will be output from the surround/surround back speakers.



- When the Dolby Surround or Neural:X decoder is selected, virtual surround processing (such as Virtual CINEMA FRONT) (p.69) does not work.
- The Neural:X decoder does not work with Dolby Digital Plus or Dolby TrueHD signals. Select “Auto” or “Dolby Dsur” for these signals.



Enjoying pure high fidelity sound (Pure Direct)

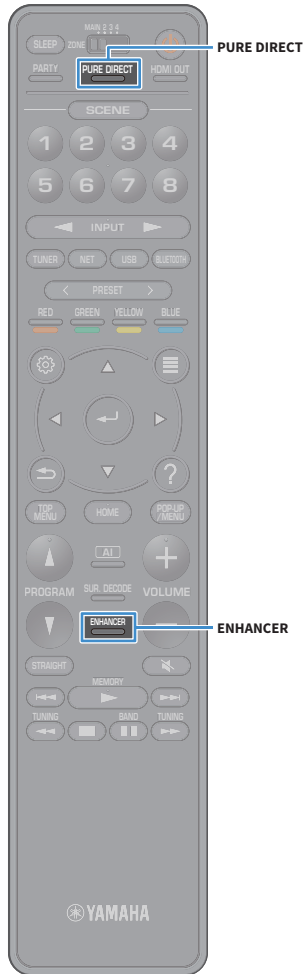

When Pure Direct is enabled, the unit plays back the selected source with the least circuitry in order to reduce the electrical noise from other circuitry (such as the front display). It allows you to enjoy Hi-Fi sound quality.

1 Press PURE DIRECT.

Each time you press the key, Pure Direct is enabled or disabled.



When Pure Direct is enabled, the following functions are not available.

- Selecting sound programs
- Operating the “Setup” menu and “Option” menu
- Using the multi-zone function
- Viewing information on the front display (when not in operation)

Playing back digitally compressed formats (such as MP3, etc.) with enriched sound (Compressed Music Enhancer)

compressed music ENHANCER

Compressed Music Enhancer adds depth and breadth to the sound, allowing you to enjoy a dynamic sound close to the original sound before it was compressed. This function can be used along with any other sound modes.

In addition, Compressed Music Enhancer enhances the quality of uncompressed digital audio (such as 2-channel PCM and FLAC) when “Hi-Res Mode” (p.111) in the “Option” menu is set to “On” (default).

1 Press ENHANCER.

Each time you press the key, Compressed Music Enhancer is enabled or disabled.



“ENHANCER” lights up



Compressed Music Enhancer does not work on the following audio sources.

- Signals whose sampling frequency is over 48 kHz
- DSD audio



- You can also use “Enhancer” (p.111) in the “Option” menu to enable/disable Compressed Music Enhancer.
- When “MULTI CH” is selected as the input source, Compressed Music Enhancer is not available.

Listening to FM/AM radio (except Australia, U.K., Europe, Middle East and Russia models)

You can tune into a radio station by specifying its frequency or selecting from registered radio stations.



- The radio frequencies differ depending on the country or region where the unit is being used.
- If you cannot obtain good reception on the radio, adjust the direction of the FM/AM antennas.

Setting the frequency steps

(Brazil, Asia and General models only)

At the factory, the frequency step setting is set to 50 kHz for FM and 9 kHz for AM. Depending on your country or region, set the frequency steps to 100 kHz for FM and 10 kHz for AM.

- 1 Set the unit to standby mode.
- 2 When holding down STRAIGHT on the front panel, press MAIN ZONE .

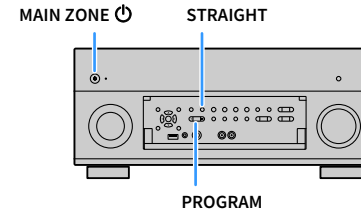

- 3 Press PROGRAM repeatedly to select “TUNER FRQ STEP”.



- 4 Press STRAIGHT to select “FM100/AM10”.
- 5 Press MAIN ZONE  to set the unit to standby mode and turn it on again.

Selecting a frequency for reception

1 Press TUNER to select “TUNER” as the input source.

2 Press BAND to select a band (FM or AM).



3 Press TUNING to set a frequency.

Hold down the key for about a second to search stations automatically.



“TUNED” lights up when a signal is received from a radio station.

“STEREO” also lights up when a stereo signal is received.



- You can switch between “Stereo” and “Monaural” for FM radio reception in “FM Mode” (p.113) in the “Option” menu. When the signal reception for an FM radio station is unstable, switching to monaural may improve it.
- You can watch videos input from external devices while listening to radio. For details see “Video Out” (p.113).



Registering favorite radio stations (presets)

You can register up to 40 radio stations as presets. Once you have registered stations, you can easily tune into them by selecting their preset numbers.



You can automatically register FM radio stations that have strong signals by using “FM Auto Preset” (p.82).

Registering a radio station manually

Select a radio station manually and register it to a preset number.

1 Follow “Selecting a frequency for reception” (p.73) to tune into the desired radio station.

2 Hold down MEMORY for seconds.

The first time that you do register a station, the selected radio station will be registered to the preset number “01”. Thereafter, each radio station you select will be registered to the next empty (unused) preset number after the most recently registered number.

Preset number



To select a preset number for registering, press MEMORY once after tuning into the desired radio station, press PRESET to select a preset number, and then press MEMORY again.

“Empty” (not in use) or the frequency currently registered



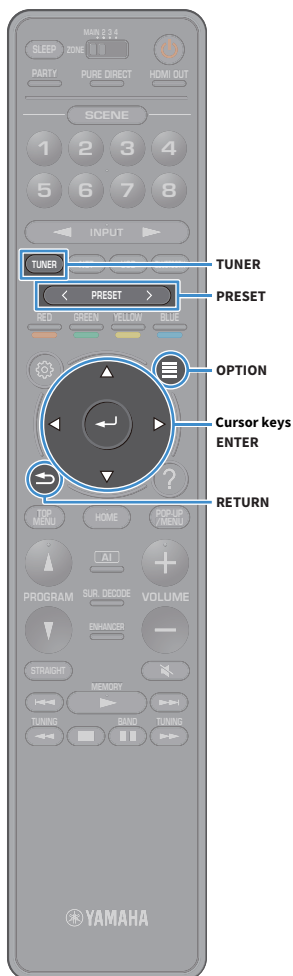

■ Registering radio stations automatically (FM Auto Preset)

Automatically register FM radio stations with strong signals.

- 1 Press TUNER to select “TUNER” as the input source.
- 2 Press OPTION.
- 3 Use the cursor keys to select “Preset” and press ENTER.



To specify the preset number from which to start the registration, press cursor keys or PRESET to select a preset number.

- 4 To start the Auto Preset process, press ENTER.



To cancel the Auto Preset process, press RETURN.

When the Auto Preset process finishes, “Finished” appears at the “Preset” screen and the “Option” menu closes automatically.

■ Selecting a preset station

Tune into a registered radio station by selecting its preset number.

- 1 Press TUNER to select “TUNER” as the input source.
- 2 Press PRESET repeatedly to select the desired radio station.



“No Presets” appears when no radio stations are registered.

■ Clearing preset stations

Clear radio stations registered to the preset numbers.

- 1 Press TUNER to select “TUNER” as the input source.
“TUNER” is selected as the input source and the frequency currently selected is displayed on the front display.
- 2 Press OPTION.
- 3 Use the cursor keys to select “Preset” and press ENTER.
- 4 Use the cursor keys to select “Clear Preset”.
- 5 Use the cursor keys to select a preset station to be cleared and press ENTER.
If the preset station is cleared, “Cleared” appears and then the next in-use preset number is displayed.
- 6 To exit from the menu, press OPTION.

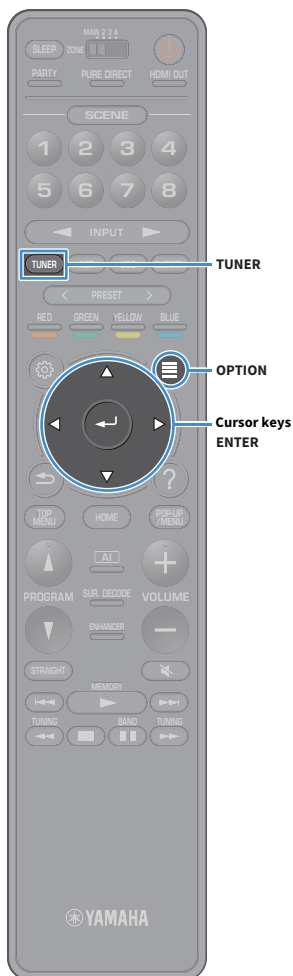

■ Clearing all preset stations

Clear all the radio stations registered to the preset numbers.

- 1** Press **TUNER** to select “TUNER” as the input source.
“TUNER” is selected as the input source and the frequency currently selected is displayed on the front display.
- 2** Press **OPTION**.
- 3** Use the cursor keys to select “Preset” and press **ENTER**.
- 4** Use the cursor keys to select “Clear All Preset”.
- 5** Use the cursor keys to select “Execute” and press **ENTER**.

If all the preset stations are cleared, “CLEAR ALL” appears and the “Option” menu closes automatically.

Listening to DAB radio (Australia, U.K., Europe, Middle East and Russia models only)

DAB (Digital Audio Broadcasting) uses digital signals for clearer sound and more stable reception compared to analog signals. The unit can also receive DAB+ (an upgraded version of DAB) that allows for more stations using MPEG-4 audio codec (AAC+), which has a more efficient transmission method.



- The unit supports Band III (174 to 240 MHz) only.
- Be sure to check the DAB coverage in your area in that not all areas are currently being covered. For a list of nationwide DAB statuses and worldwide DAB frequencies, check WorldDAB online at <http://www.worlddab.org/>.



For details on the antenna connection, see “Connecting the radio antennas” (p.38).

Preparing the DAB tuning

Before tuning into DAB radio stations, follow the procedure below to perform an initial scan.

1 Press TUNER to select “TUNER” as the input source.

2 Press BAND to select the DAB band.

The following message appears on the front panel if you have not performed an initial scan yet.



3 Press ENTER to start an initial scan.



When the initial scan finishes, the unit automatically tunes into the first DAB radio station as stored in station order.



- If no DAB radio stations are found by an initial scan, the message in Step 1 appears again. Press ENTER to start an initial scan again.
- You can check reception strength of each DAB channel label (p.79).
- To perform an initial scan again after some DAB radio stations are stored, select “Init Scan” (p.109) in the “Option” menu. If you perform an initial scan again, the DAB radio stations currently registered to the preset numbers will be cleared.

Selecting a DAB radio station for reception

You can select a DAB radio station from the stations stored by the initial scan.

1 Press TUNER to select “TUNER” as the input source.

2 Press BAND to select the DAB band.

3 Press TUNING repeatedly to select a DAB radio station.



- “Off Air” appears when the selected DAB radio station is currently not available.
- When the unit is receiving a secondary station, “2” appears next to “DAB”.

Secondary station



You can watch videos input from external devices while listening to radio by selecting the video input jack in “Video Out” (p.113) in the “Option” menu.



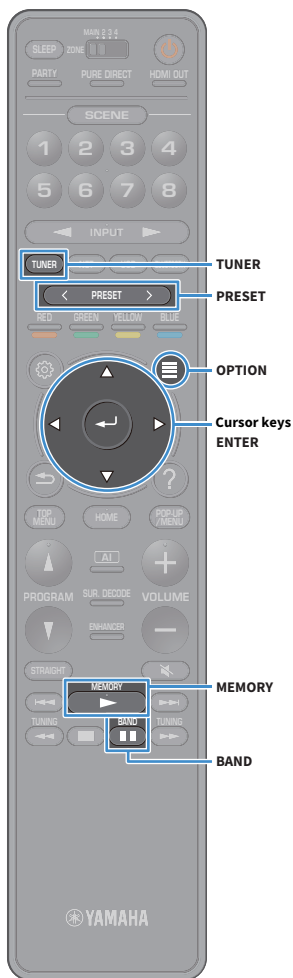

Registering favorite DAB radio stations (presets)

You can register up to 40 DAB radio stations as presets. Once you have registered stations, you can easily tune into them by selecting their preset numbers.



You can register up to 40 favorite radio stations each for DAB and FM bands.

■ Registering a DAB radio station as presets

Select a DAB radio station and register it to a preset number.

- 1 Follow “Selecting a DAB radio station for reception” (p.76) to tune into the desired DAB radio station.
- 2 Hold down MEMORY for seconds.

The first time that you do register a station, the selected radio station will be registered to the preset number “01”. Thereafter, each radio station you select will be registered to the next empty (unused) preset number after the most recently registered number.



To select a preset number for registering, press MEMORY once after tuning into the desired DAB radio station, press PRESET to select a preset number, and then press MEMORY again.

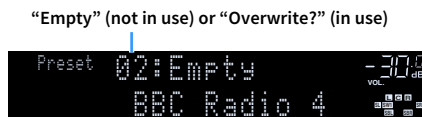

■ Selecting a preset DAB radio station

Tune into a registered DAB radio station by selecting its preset number.

- 1 Press TUNER to select “TUNER” as the input source.
- 2 Press BAND to select the DAB band.
- 3 Press PRESET repeatedly to select the desired DAB radio station.



“No Presets” appears when no DAB radio stations are registered.

■ Clearing preset DAB radio stations

Clear DAB radio stations registered to the preset numbers.

- 1 Press TUNER to select “TUNER” as the input source. “TUNER” is selected as the input source and the frequency currently selected is displayed on the front display.
- 2 Press OPTION.
- 3 Use the cursor keys to select “Preset” and press ENTER.
- 4 Use the cursor keys to select a preset DAB radio station to be cleared and press ENTER. If the preset station is cleared, “Cleared” appears and then the next in-use preset number is displayed.
- 5 To exit from the menu, press OPTION.

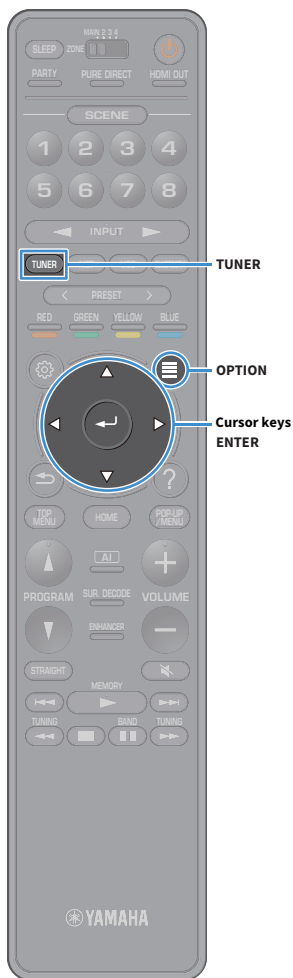

■ Clearing all preset DAB radio stations

Clear all the DAB radio stations registered to the preset numbers.

- 1 Press **TUNER** to select “TUNER” as the input source.
“TUNER” is selected as the input source and the frequency currently selected is displayed on the front display.
- 2 Press **OPTION**.
- 3 Use the cursor keys to select “Preset” and press **ENTER**.
- 4 Use the cursor keys to select “Clear All Preset”.
- 5 Use the cursor keys to select “Execute” and press **ENTER**.
If all the preset stations are cleared, “CLEAR ALL” appears and the “Option” menu closes automatically.

Displaying the DAB information

The unit can receive various types of DAB information when it is tuned into a DAB radio station.

- 1 Tune into the desired DAB radio station.
- 2 Press **INFO** on the front panel.

Each time you press the key, the displayed item changes.



Item name

About 3 seconds later, the corresponding information for the displayed item appears.



Information

DLS (Dynamic Label Segment)	Information on the current station
Ensemble Label	Ensemble name
Program Type	Station genre
Date And Time	Current date and time
Audio Mode	Audio mode (monaural/stereo) and bit rate
CH Label/Freq.	Channel label and frequency
Signal Quality	Signal reception quality (0 [none] to 100 [best])
DSP Program	Sound mode name
Audio Decoder	Decoder name



Some information may not be available depending on the selected DAB radio station.

Checking reception strength of each DAB channel label

You can check reception strength of each DAB channel label (0 [none] to 100 [best]).

- 1 Press TUNER to select “TUNER” as the input source.
- 2 Press BAND to select the DAB band.
- 3 Press OPTION.
- 4 Use the cursor keys to select “Tune AID” and press ENTER.
- 5 Use the cursor keys to select the desired DAB channel label.



- 6 To exit from the menu, press RETURN.

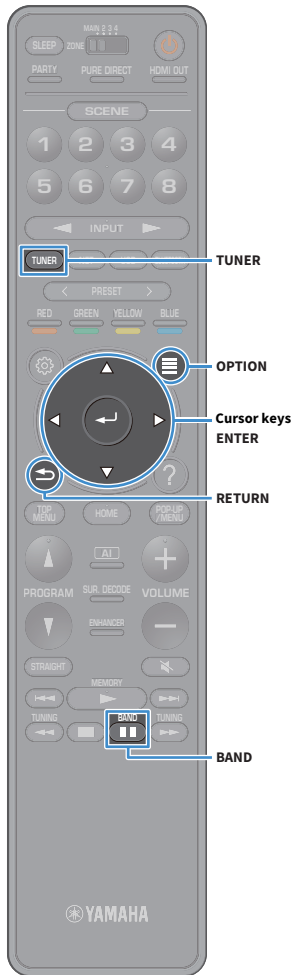

DAB frequency information

The unit supports Band III (174 to 240 MHz) only.

Frequency	Channel label
174.928 MHz	5A
176.640 MHz	5B
178.352 MHz	5C
180.064 MHz	5D
181.936 MHz	6A
183.648 MHz	6B
185.360 MHz	6C
187.072 MHz	6D
188.928 MHz	7A
190.640 MHz	7B
192.352 MHz	7C
194.064 MHz	7D
195.936 MHz	8A
197.648 MHz	8B
199.360 MHz	8C
201.072 MHz	8D
202.928 MHz	9A
204.640 MHz	9B
206.352 MHz	9C
208.064 MHz	9D
209.936 MHz	10A
211.648 MHz	10B
213.360 MHz	10C
215.072 MHz	10D
216.928 MHz	11A
218.640 MHz	11B
220.352 MHz	11C
222.064 MHz	11D
223.936 MHz	12A

Frequency	Channel label
225.648 MHz	12B
227.360 MHz	12C
229.072 MHz	12D
230.784 MHz	13A
232.496 MHz	13B
234.208 MHz	13C
235.776 MHz	13D
237.488 MHz	13E
239.200 MHz	13F

Listening to FM radio (Australia, U.K., Europe, Middle East and Russia models only)

You can tune into a radio station by specifying its frequency or selecting from registered radio stations.



If you cannot obtain good reception on the radio, adjust the direction of the DAB/FM antennas.



Selecting a frequency for reception

- 1 Press TUNER to select “TUNER” as the input source.
- 2 Press BAND to select the FM band.



- 3 Press TUNING to set a frequency.

Hold down the key for about a second to search stations automatically.



“TUNED” lights up when a signal is received from a radio station.

“STEREO” also lights up when a stereo signal is received.



- You can switch between “Stereo” and “Monaural” for FM radio reception in “FM Mode” (p.113) in the “Option” menu. When the signal reception for an FM radio station is unstable, switching to monaural may improve it.
- You can watch videos input from external devices while listening to radio. For details see “Video Out” (p.113).

Registering favorite FM radio stations (presets)

You can register up to 40 FM radio stations as presets. Once you have registered stations, you can easily tune into them by selecting their preset numbers.



You can automatically register FM radio stations that have strong signals by using “FM Auto Preset” (p.74).

Registering a radio station manually

Select a radio station manually and register it to a preset number.

1 Follow “Selecting a frequency for reception” (p.81) to tune into the desired radio station.

2 Hold down MEMORY for seconds.

The first time that you do register a station, the selected radio station will be registered to the preset number “01”. Thereafter, each radio station you select will be registered to the next empty (unused) preset number after the most recently registered number.

Preset number



To select a preset number for registering, press MEMORY once after tuning into the desired radio station, press PRESET to select a preset number, and then press MEMORY again.

“Empty” (not in use) or the frequency currently registered

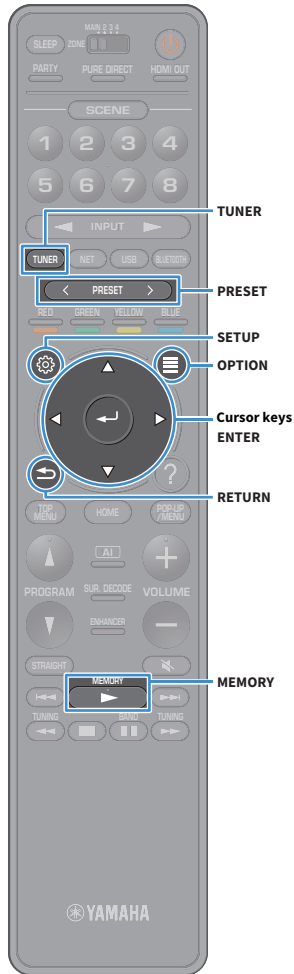

Registering radio stations automatically (FM Auto Preset)

Automatically register FM radio stations with strong signals.



(U.K., Europe, Russia and Middle East models only)

Only Radio Data System broadcasting stations are stored automatically by “FM Auto Preset”.

- 1** Press TUNER to select “TUNER” as the input source.
- 2** Press OPTION.
- 3** Use the cursor keys to select “Preset” and press ENTER.



To specify the preset number from which to start the registration, press cursor keys or PRESET to select a preset number.

- 4** To start the Auto Preset process, press ENTER.



To cancel the Auto Preset process, press RETURN.

When the Auto Preset process finishes, “Finished” appears at the “Preset” screen and the “Option” menu closes automatically.

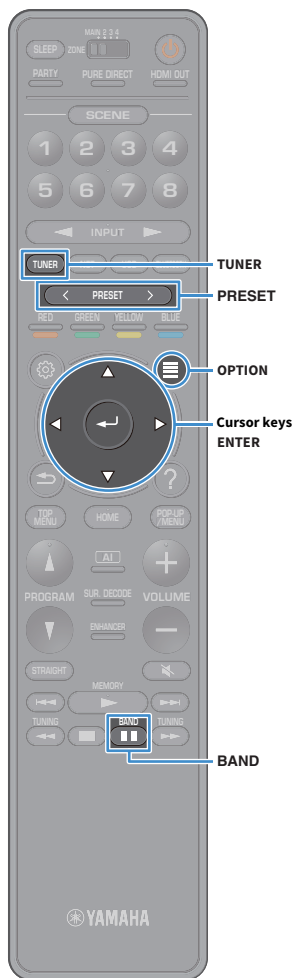

■ Selecting a preset station

Tune into a registered radio station by selecting its preset number.

- 1 Press **TUNER** to select “TUNER” as the input source.
- 2 Press **BAND** to select the FM band
- 3 Press **PRESET** repeatedly to select the desired radio station.



“No Presets” appears when no radio stations are registered.

■ Clearing preset stations

Clear radio stations registered to the preset numbers.

- 1 Press **TUNER** to select “TUNER” as the input source.
“TUNER” is selected as the input source and the frequency currently selected is displayed on the front display.
- 2 Press **OPTION**.
- 3 Use the cursor keys to select “Preset” and press **ENTER**.
- 4 Use the cursor keys to select “Clear Preset”.
- 5 Use the cursor keys to select a preset station to be cleared and press **ENTER**.

If the preset station is cleared, “Cleared” appears and then the next in-use preset number is displayed.

- 6 To exit from the menu, press **OPTION**.

■ Clearing all preset stations

Clear all the radio stations registered to the preset numbers.

- 1 Press **TUNER** to select “TUNER” as the input source.
“TUNER” is selected as the input source and the frequency currently selected is displayed on the front display.
- 2 Press **OPTION**.
- 3 Use the cursor keys to select “Preset” and press **ENTER**.
- 4 Use the cursor keys to select “Clear All Preset”.
- 5 Use the cursor keys to select “Execute” and press **ENTER**.

If all the preset stations are cleared, “CLEAR ALL” appears and the “Option” menu closes automatically.

Radio Data System tuning

(U.K., Europe, Middle East and Russia models only)

Radio Data System is a data transmission system used by FM stations in many countries. The unit can receive various types of Radio Data System data, such as “Program Service”, “Program Type”, “Radio Text” and “Clock Time”, when it is tuned into a Radio Data System broadcasting station.

■ Displaying the Radio Data System information

1 Tune into the desired Radio Data System broadcasting station.



We recommend using “FM Auto Preset” to tune into the Radio Data System broadcasting stations (p.82).

2 Press INFO on the front panel.

Each time you press the key, the displayed item changes.



Item name

About 3 seconds later, the corresponding information for the displayed item appears.

Frequency (always displayed)



Information

Program Service	Program service name
Program Type	Current program type
Radio Text	Information on the current program
Clock Time	Current time
DSP Program	Sound mode name
Audio Decoder	Decoder name



“Program Service”, “Program Type”, “Radio Text”, and “Clock Time” are not displayed if the radio station does not provide the Radio Data System service.

Playing back music via Bluetooth

You can play back music files stored on a Bluetooth device (such as smartphones) on the unit.

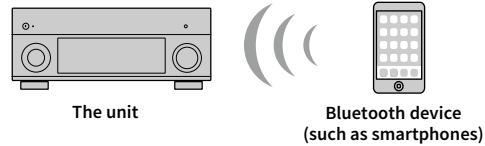

- To use the Bluetooth function, set “Bluetooth” (p.138) in the “Setup” menu to “On”.
- Stand the wireless antenna upright for connecting to a Bluetooth device wirelessly. For details, see “Preparing the wireless antenna” (p.39).



For details on supported Bluetooth devices, see “Supported devices and file formats” (p.167).



Playing back Bluetooth device music on the unit

Follow the procedure below to establish a Bluetooth connection between a Bluetooth device (such as smartphones) and the unit, and play back music stored the Bluetooth device on the unit.



The unit does not support video playback via Bluetooth.

- 1** Press **BLUETOOTH** to select “Bluetooth” as the input source.
- 2** On the Bluetooth device, select the unit (network name of the unit) from the available device list.

A connection between the Bluetooth device and the unit will be made.

If the pass key is required, enter the number “0000”.
- 3** On the Bluetooth device, select a song and start playback.

The playback screen (artist name, album name and song title) is displayed on the TV.



- If the unit detects the Bluetooth device previously connected, the unit automatically connects to the Bluetooth device after Step 1. To establish another Bluetooth connection, first terminate the current Bluetooth connection.
- To terminate the Bluetooth connection, perform one of the following operations.
 - Perform the disconnect operation on the Bluetooth device.
 - Select an input source other than “Bluetooth” on the unit.
 - Select “Disconnect” in “Bluetooth” (p.138) in the “Setup” menu.
- You can use the playback operation keys (▶, ■, ■■, ◀, ▶▶) on the remote control to control playback.

Playing back music stored on a USB storage device

You can play back music files stored on a USB storage device on the unit.

The unit supports USB mass storage class devices (FAT16 or FAT32 format).



For details on playable file formats, see “Supported devices and file formats” (p.167).

Connecting a USB storage device

1 Connect the USB storage device to the USB jack.

The unit (front)

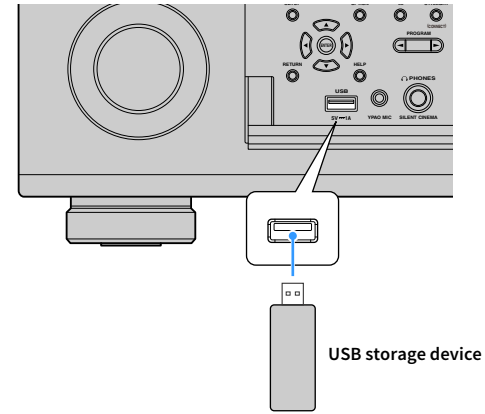

If the USB storage device contains many files, it may take time to load them. In this case, “Loading...” appears in the front display.



- Stop playback of the USB storage device before disconnect it from the USB jack.
- Connect a USB memory device directly to the USB jack of the unit. Do not use extension cables.
- The unit cannot charge USB devices while it is in standby mode.

Playback of USB storage device contents

Follow the procedure below to operate the USB storage device contents and start playback.

You can control the USB memory device with the menu displayed on the TV screen.

1 Press USB to select “USB” as the input source.

The browse screen is displayed on the TV.



If playback is ongoing on your USB storage device, the playback screen is displayed.

2 Use the cursor keys to select an item and press ENTER.

If a song is selected, playback starts and the playback screen is displayed.

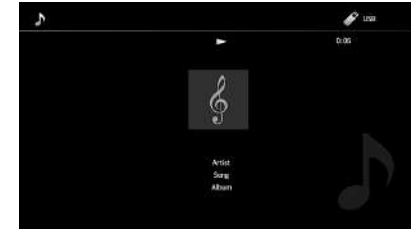

- To return to the previous screen, press RETURN.
- To return to the top screen during menu operations on the browse screen, hold down RETURN.
- Files not supported by the unit cannot be selected.
- If the unit detects a series of unsupported files (such as images and hidden files) during playback, playback stops automatically.
- You can register your favorite items as shortcuts and access them directly by selecting the shortcut numbers (p.105).

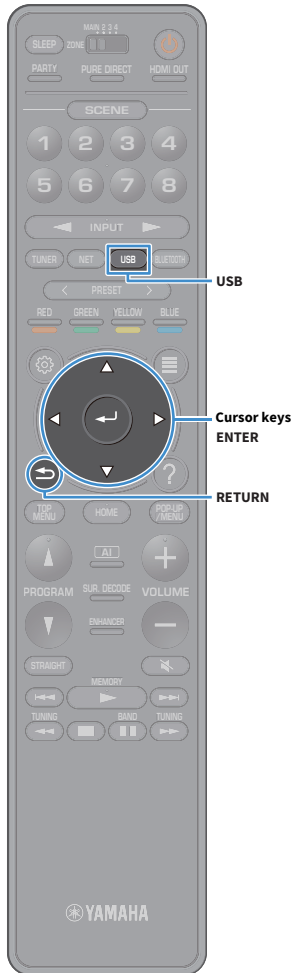



Browse screen



1 Status indicators

Display the current shuffle/repeat settings (p.89).

2 Contents list

Displays the list of USB storage device contents. Use the cursor keys to select an item and press ENTER to confirm the selection.

3 Item number/total

4 Operation menu

Use the cursor keys to select an item. Press ENTER to confirm the selection.

Menu	Function
1 Page Up	Moves to the previous/next page of the list.
1 Page Down	
Now Playing	Moves to the playback screen.
10 Pages Up	Moves 10 pages forward/backward.
10 Pages Down	



When "Video Out" in the "Option" menu is set to except "Off", you can close the browse screen by pressing the left cursor key. To display the browse screen again, press any cursor key. For details on see "Video Out" (p.113).

Playback screen



1 Status indicators

Display the current shuffle/repeat settings (p.89), playback status (such as play/pause) and elapsed time.

2 Playback information

Displays the artist name, album name and song title.



You can use the playback operation keys (▶, ■, ■■, ◀◀, ▶▶) on the remote control to control playback.

■ Shuffle/repeat settings

You can configure the shuffle/repeat settings for playback of USB storage device contents.

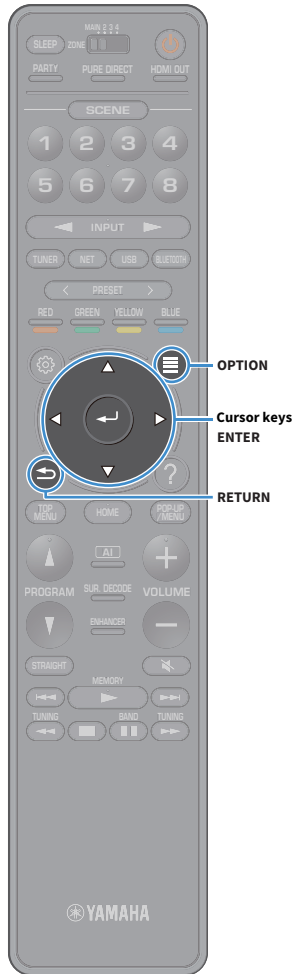



- 1 When “USB” is selected as the input source, press **OPTION**.
- 2 Use the cursor keys to select “Shuffle/Repeat” and press **ENTER**.



- To return to the previous screen during menu operations, press **RETURN**.
- Texts in parentheses denote indicators on the front display.

- 3 Use the cursor keys to select “Shuffle” (Shuffle) or “Repeat” (Repeat) and select a setting.

Item	Setting	Function
Shuffle (Shuffle)	Off (Off)	Turns off the shuffle function.
	On (On)	Plays back songs in the current album (folder) in random order. “  ” appears on the TV screen.
Repeat (Repeat)	Off (Off)	Turns off the repeat function.
	One (One)	Plays back the current song repeatedly. “  ” appears on the TV screen.
	All (All)	Plays back all songs in the current album (folder) repeatedly. “  ” appears on the TV screen.

- 4 To exit from the menu, press **OPTION**.

Playing back music stored on media servers (PCs/NAS)

You can play back music files stored on your media servers on the unit.



- To use this function, the unit and your PC must be connected to the same router (p.39). You can check whether the network parameters (such as the IP address) are properly assigned to the unit in “Network” (p.135) in the “Setup” menu.
- The audio may be interrupted while using the wireless network connection. In this case, use the wired network connection.



For details on playable file formats, see “Supported devices and file formats” (p.167).

Media sharing setup

To play back music files stored on your PC or media servers, first you need to configure the media sharing setting on each music server.

■ For a PC with Windows Media Player installed

The setting procedure may vary depending on the PC and Windows Media Player version (The following procedure is a setup example for Windows Media Player 12).

- 1 Start Windows Media Player 12 on your PC.
- 2 Select “Stream”, then “Turn on media streaming”.
- 3 Click “Turn on media streaming”.
- 4 Select “Allowed” from the drop-down list next to the unit’s model name.
- 5 Click “OK” to exit.



For details on media sharing settings, refer to Windows Media Player help.

■ For a PC or a NAS with other media server software installed

Refer to the instruction manual for the device or software and configure the media sharing settings.

Playback of PC music contents

Follow the procedure below to operate the PC music contents and start playback.

You can control the PC/NAS with the menu displayed on the TV screen.

- 1 Press NET repeatedly to select “SERVER” as the input source.

The browse screen is displayed on the TV.



If playback of a music file selected from the unit is ongoing on your PC, the playback screen is displayed.

- 2 Use the cursor keys to select a music server and press ENTER.

- 3 Use the cursor keys to select an item and press ENTER.

If a song is selected, playback starts and the playback screen is displayed.

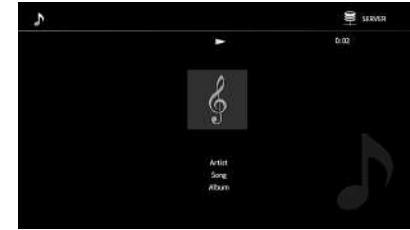

- To return to the previous screen, press RETURN.
- To return to the top screen during menu operations on the browse screen, hold down RETURN.
- Files not supported by the unit cannot be selected.
- If the unit detects a series of unsupported files (such as images and hidden files) during playback, playback stops automatically.
- You can register your favorite items as shortcuts and access them directly by selecting the shortcut numbers (p.105).

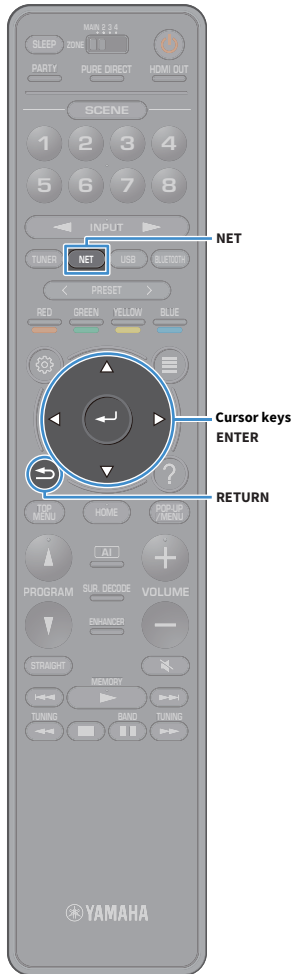



■ Browse screen



1 Status indicators

Display the current shuffle/repeat settings (p.93).

2 Contents list

Displays the list of PC content. Use the cursor keys to select an item and press ENTER to confirm the selection.

3 Item number/total

4 Operation menu

Use the cursor keys to select an item. Press ENTER to confirm the selection.

Menu	Function
1 Page Up	Moves to the previous/next page of the list.
1 Page Down	
Now Playing	Moves to the playback screen.
10 Pages Up	Moves 10 pages forward/backward.
10 Pages Down	



When “Video Out” in the “Option” menu is set to except “Off”, you can close the browse screen by pressing the left cursor key. To display the browse screen again, press any cursor key. For details on see “Video Out” (p.113).

■ Playback screen



1 Status indicators

Display the current shuffle/repeat settings (p.93), playback status (such as play/pause) and elapsed time.

2 Playback information

Displays the artist name, album name and song title.





You can use the playback operation keys (▶, ■, ■■, ◀◀, ▶▶) on the remote control to control playback.

■ Shuffle/repeat settings

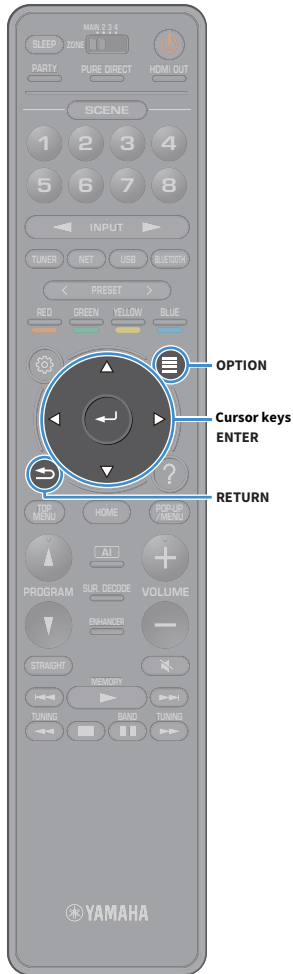
You can configure the shuffle/repeat settings for the playback of PC music content.



- 1 When “SERVER” is selected as the input source, press **OPTION**.
- 2 Use the cursor keys to select “Shuffle/Repeat” and press **ENTER**.
 - To return to the previous screen during menu operations, press **RETURN**.
 - Text in parentheses denotes indicators on the front display.
- 3 Use the cursor keys to select “Shuffle” (Shuffle) or “Repeat” (Repeat) and select a setting.

Item	Setting	Function
Shuffle (Shuffle)	Off (Off)	Turns off the shuffle function.
	On (On)	Plays back songs in the current album (folder) in random order. “  ” appears on the TV screen.
Repeat (Repeat)	Off (Off)	Turns off the repeat function.
	One (One)	Plays back the current song repeatedly. “  ” appears on the TV screen.
	All (All)	Plays back all songs in the current album (folder) repeatedly. “  ” appears on the TV screen.

- 4 To exit from the menu, press **OPTION**.

Listening to Internet radio

You can listen to Internet radio stations from all over the world.



- To use this function, the unit must be connected to the Internet (p.39). You can check whether the network parameters (such as the IP address) are properly assigned to the unit in “Information” (p.135) in the “Network” menu.
- You may not be able to receive some Internet radio stations.
- The unit uses the airable.Radio service. airable is a service of Tune In GmbH.
- This service may be discontinued without notice.
- Folder names are different depending on the language.

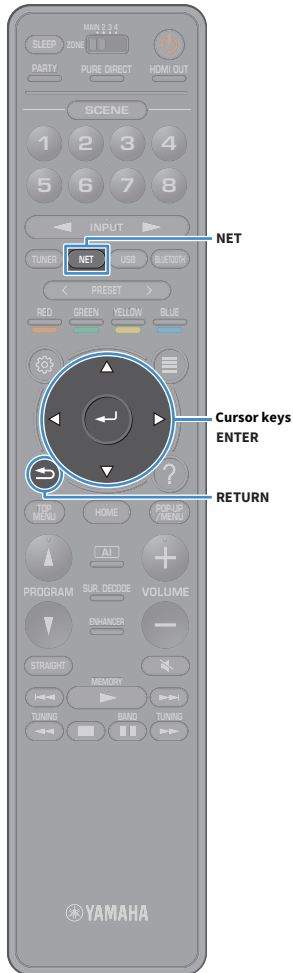

Playback of Internet radio

- 1 Press NET repeatedly to select “NET RADIO” as the input source.

The browse screen is displayed on the TV.



- 2 Use the cursor keys to select an item and press ENTER.

If an Internet radio station is selected, playback starts and the playback screen is displayed.

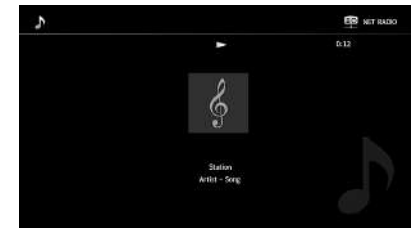

- To return to the previous screen, press RETURN.
- You can register your favorite items as shortcuts and access them directly by selecting the shortcut numbers (p.105).



■ Browse screen



1 Contents list

Displays the list of Internet radio content. Use the cursor keys to select an item and press ENTER to confirm the selection.

2 Item number/total

3 Operation menu

Use the cursor keys to select an item. Press ENTER to confirm the selection.

Menu	Function
1 Page Up	Moves to the previous/next page of the list.
1 Page Down	
Now Playing	Moves to the playback screen.
10 Pages Up	Moves 10 pages forward/backward.
10 Pages Down	



When "Video Out" in the "Option" menu is set to except "Off", you can close the browse screen by pressing the left cursor key. To display the browse screen again, press any cursor key. For details on see "Video Out" (p.113).

■ Playback screen



1 Playback indicator

Displays the elapsed time.

2 Playback information

Displays the station name, album name and song title.



- You can use the playback operation key (■) on the remote control to stop playback.
- Some information may not be available depending on the station.

Registering favorite Internet radio stations (Favorites)

By registering your favorite Internet radio stations to “Favorites”, you can quickly access to them from the “Favorites” folder in the browse screen.



You can also register up to 40 favorite USB and network contents or Bluetooth input source as shortcuts (p.105).

■ Registering the station on the browse/playback screen

- 1 Select the desired Internet radio station in the browse screen or start playback of it to display the playback screen.
- 2 Press OPTION.
- 3 Use the cursor key to select “Add to favorites” and press ENTER.

The selected station is added to the “Favorites” folder.

Radio stations registered to favorites are displayed with “★”.

Browse screen



To remove a station that is registered to favorites, select the station and then select “Remove from favorites”.

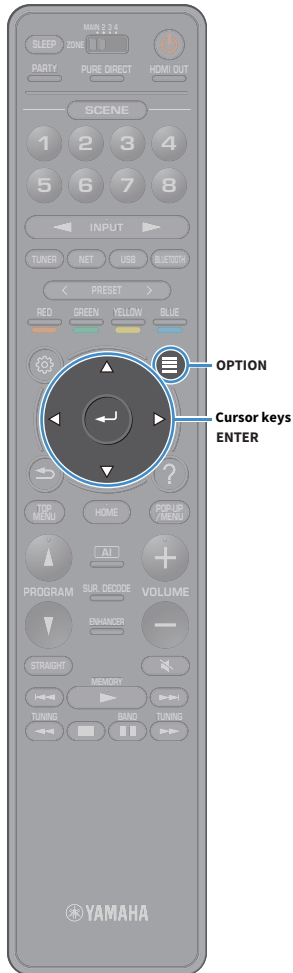

Playing back iTunes/iPod music with AirPlay

The AirPlay function allows you to play back iTunes/iPod music on the unit via network.

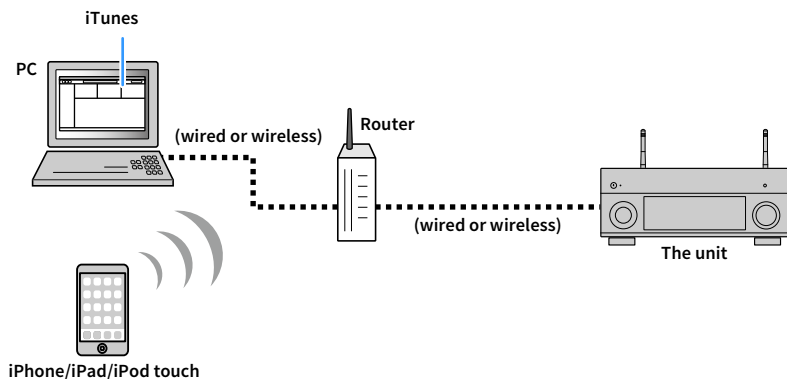

- To use this function, the unit and your PC or iPod must be connected to the same router. You can check whether the network parameters (such as the IP address) are properly assigned to the unit in “Information” (p.135) in the “Setup” menu.
- When using a multiple SSID router, access to the unit might be restricted depending on the SSID to connect. Connect the iPod to the SSID which can access the unit.



For details on supported iPod devices, see “Supported devices and file formats” (p.167).

Playback of iTunes/iPod music contents

Follow the procedure below to play back iTunes/iPod music contents on the unit.

1 Turn on the unit, and start iTunes on the PC or display the playback screen on the iPod.

If the iTunes/iPod recognizes the unit, the AirPlay icon appears.

iTunes (example)



iOS (example)

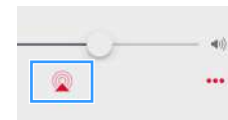

If the icon does not appear, check whether the unit and PC/iPod are connected to the router properly.

2 On the iTunes/iPod, click (tap) the AirPlay icon and select the unit (network name of the unit) as the audio output device.

3 Select a song and start playback.

The unit automatically selects “AirPlay” as the input source and starts playback.

The playback screen is displayed on the TV.



- You can turn on the unit automatically when starting playback on iTunes or iPod by setting “Network Standby” (p.136) in the “Setup” menu to “On”.
- You can edit the network name (the unit’s name on the network) displayed on iTunes/iPod in “Network Name” (p.138) in the “Setup” menu.
- You can adjust the unit’s volume from the iTunes/iPod during playback. To disable volume controls from iTunes/iPod, set “AirPlay Volume Interlock” (p.137) in the “Network” menu to “Off”.

Caution

When you use iTunes/iPod controls to adjust volume, the volume may be unexpectedly loud. This could result in damage to the power amplifier or speakers. If the volume suddenly increases during playback, stop playback on the iTunes/iPod immediately.

■ Playback screen



Playback operation keys

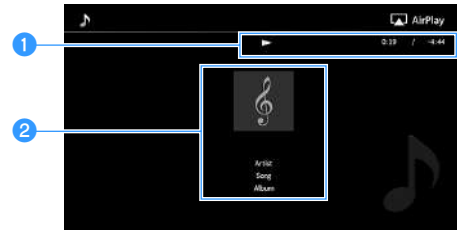

1 Playback indicator

Displays the elapsed/remaining time.

2 Playback information

Displays the artist name, album name and song title.



You can use the playback operation keys (▶, ■, ■, ◀, ▶▶) on the remote control to control playback.

Playing back videos/audio in multiple rooms (multi-zone)

The multi-zone function allows you to play back different input sources in the room where the unit is installed (main zone) and in other rooms (Zone2, Zone3 and Zone4).

For example, while you are watching TV in the living room (main zone), another person can listen to PC music in the study room (Zone2), and another can listen to radio in the guest room (Zone3) and play DVD in the kitchen (Zone4).

- Audio signals that can be output to each zone vary depending on how you connect the device in each zone to the unit's output jacks. For details, see "Multi-zone output" (p.169).

Multi-zone configuration examples

Since there are many possible ways to use the unit in a multi-zone configuration, we recommend that you consult with your nearest authorized Yamaha dealer or service center about the multi-zone connections that best meet your requirements.

Enjoying music in other rooms

You can enjoy music using speakers placed in other rooms.

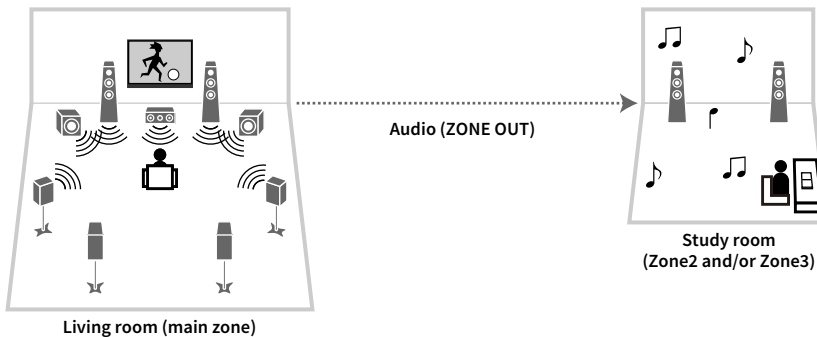

Connections

Speakers (using an external amplifier): p.100

Enjoying videos/music in other rooms

You can enjoy videos/music using TVs placed in other rooms.

Enjoying videos/music using a TV and speakers

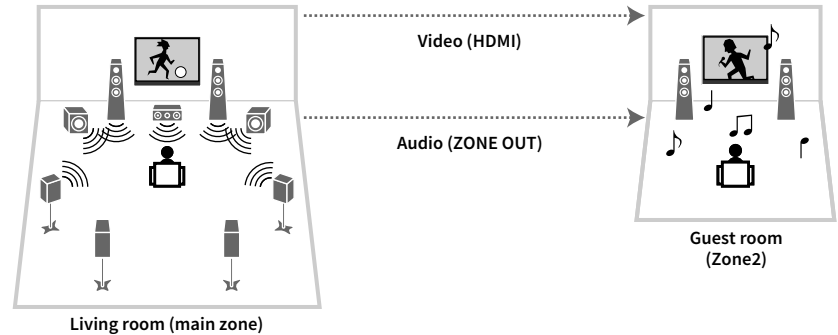

Connections

TV: p.101

Speakers (using an external amplifier): p.100

Enjoying videos/music using only a TV

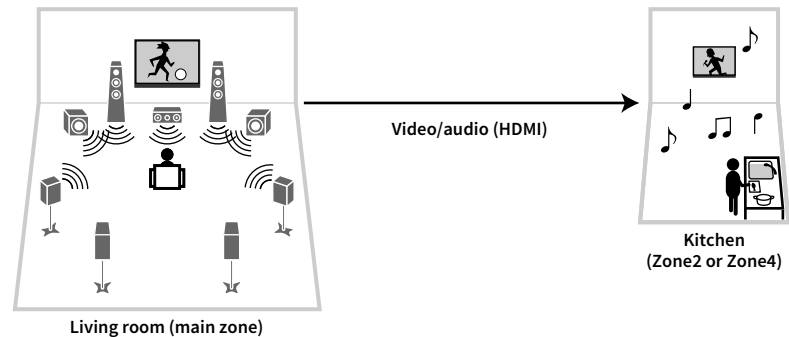

Connection

TV: p.101

Preparing the multi zone system

Connect the device that will be used in other rooms to the unit.

Caution

- Remove the unit's power cable from the AC wall outlet before connecting an external amplifier.

■ Connecting speakers to play back audio

Connect the external amplifier placed in Zone2 or Zone3 to the unit with a stereo pin cable and connect speakers to the external amplifier.

The unit (rear)

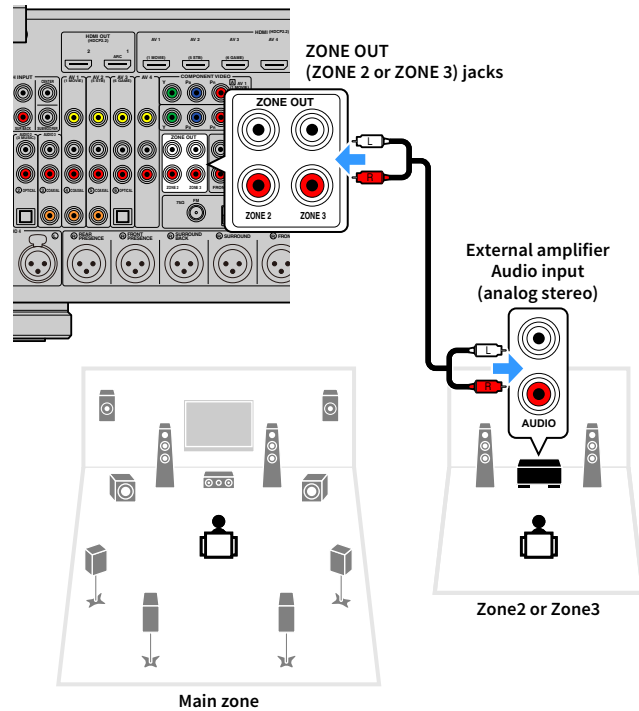

You can adjust the volume for Zone2 and Zone3 output with the unit. When using an external amplifier with volume control, set "Volume" (p.139) in the "Setup" menu to "Fixed".

■ Connecting an HDMI-compatible device to play back videos/audio

Connect an HDMI-compatible device (such as a TV) to play back videos/audio at Zone2 or Zone4. If you connect an AV amplifier, you can enjoy multichannel playback in another room (Zone4).



- To watch videos played back on a video device at Zone2 or Zone4, you need to connect the video device to the unit with an HDMI cable (p.34).
- We recommend that you disable HDMI Control on the playback devices connected to the unit.
- The “Setup” menu and “Option” menu cannot be used with Zone2 or Zone4, but browsing or play back are possible with a network, USB or Bluetooth connection in Zone2.

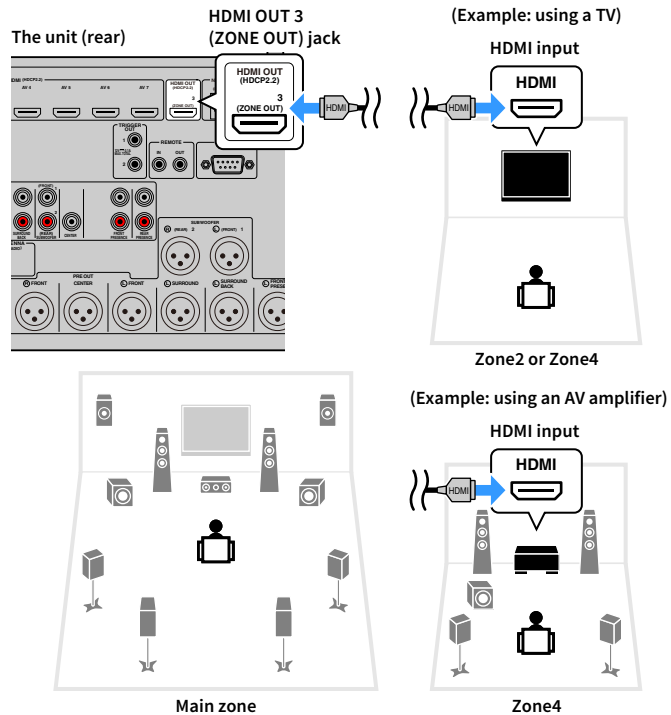

- Videos/audio interruptions may happen in another zone when any of the following operations is performed.
 - Tuning on/off a TV connected to the unit via HDMI or switching the TV input
 - Enabling/disabling a zone output or selecting its input source
 - Changing the sound mode or audio settings

To assign the HDMI OUT 3 (ZONE OUT) jack to Zone2 or Zone4, set “HDMI ZONE OUT Assign” (p.135) in the “Setup” menu to “Zone2” or “Zone4”.

Operating the unit from another room (remote connection)

You can operate the unit and external devices from Zone2, Zone3 or Zone4 using the supplied remote control if you connect an infrared signal receiver/emitter to the unit's REMOTE IN/OUT jacks.

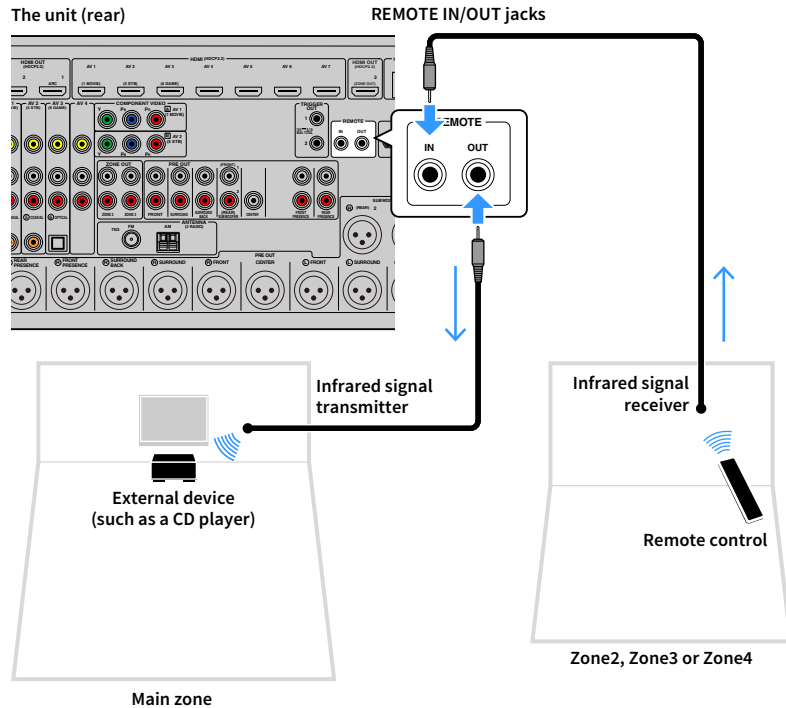

Remote connections between Yamaha products

An infrared signal transmitter is not required if you are using Yamaha products that support remote connections, as the unit does. You can transmit remote control signals by connecting the REMOTE IN/OUT jacks with monaural mini-jack cables and an infrared signal receiver.

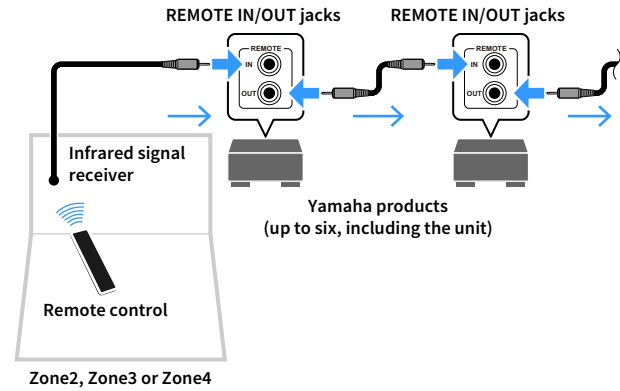

Controlling Zone2, Zone3 or Zone4



1 Use the ZONE switch to select a zone.

2 Press (receiver power).

Each time you press the key, the selected zone is enabled or disabled.

When zone audio output is enabled, the corresponding zone indicator lights up in the front display.

3 Use the input selection keys to select an input source.



- Audio signals that can be output to each zone vary depending on how you connect the device in each zone to the unit's output jacks. For details, see "Multi-zone output" (p.169).
- You cannot select Bluetooth, USB and network sources exclusively for each zone. For example, if you select "SERVER" for Zone2 when "USB" is selected for the main zone, the input source for the main zone also switches to "SERVER".

4 Start playback on the external device or select a radio station.

Refer to the instruction manual for the external device.

For details on the following operations, see the corresponding pages.

- Listening to FM/AM radio (except Australia, U.K., Europe, Middle East and Russia models) (p.72)
- Listening to DAB radio (Australia, U.K., Europe, Middle East and Russia models only) (p.75)
- Listening to FM radio (Australia, U.K., Europe, Middle East and Russia models only) (p.81)
- Playing back music via Bluetooth (p.85)
- Playing back music stored on a USB storage device (p.86)
- Playing back music stored on media servers (PCs/NAS) (p.90)
- Listening to Internet radio (p.94)
- Playing back iTunes/iPod music with AirPlay (p.97)



AirPlay is available in Zone2 and Zone3 only when AirPlay playback is ongoing in the main zone.



- The Zone2/Zone3 input automatically switches in conjunction with the input source selected in the main zone when "Main Zone Sync" is selected as the Zone3/Zone3 input.
- To play back DSD audio or signals with a sampling frequency of 352.8 kHz or 384 kHz in Zone2, select "Main Zone Sync" as the Zone2 input, or use the party mode (p.104).
- Depending on the "Remote Key" (p.143) setting in the "System" menu, the PROGRAM key may be also available in Zone2.

Caution

To avoid unexpected noise, never play back DTS-CDs in Zone2, Zone3 or Zone4.



■ Other operations for Zone2, Zone3 or Zone4

The following functions are also available when the zone you want to operate is enabled.

Adjusting the volume (for Zone2 and Zone3 only)

Press VOLUME or MUTE.

Selecting the input source and settings at once (SCENE)

Press SCENE 1-8.



To register the current settings (input source, volume and tone control) to a scene, hold down the desired SCENE1-8 key until “SET Complete” appears on the front display. (Only an input source can be registered for Zone4.)

Setting the sleep timer

Press SLEEP repeatedly to set the time (120 min, 90 min, 60 min, 30 min, off).

Playing back digitally compressed formats (such as MP3, etc.) with enriched sound (Compressed Music Enhancer)

Press ENHANCER.



Depending on the “Remote Key” (p.143) setting, the PROGRAM Key may be also available in Zone2 and Zone3.

■ Enjoying the same source in multiple rooms (party mode)

The party mode allows you to play back in all zones the same music that is being played back in the main zone. During the party mode, stereo playback is automatically selected for all zones. Utilize this function when you want to use main zone music as background music for a house party.

1 Press PARTY.

Each time you press the key, the party mode is turned on or off.

When the party mode is turned on, “PARTY” lights up in the front display.



You can select the zones to be included in the party mode in “Party Mode Set” (p.141) in the “Setup” menu.



Zone4 output is available only when an HDMI input is selected in the main zone.

Registering favorite items (shortcut)

You can register up to 40 favorite USB and network contents or Bluetooth input source as shortcuts and access them directly by selecting the shortcut numbers.



- You can also use the “Favorites” feature to register Internet radio stations (p.96).
- Only the input source will be registered for Bluetooth and AirPlay. Individual contents cannot be registered.

Registering an item

Select a desired item and register it to a shortcut number.

- 1 Play back a song or a radio station to be registered.
- 2 Hold down MEMORY for a few seconds.



Shortcut number (flashes)



To change a shortcut number to which the item will be registered, use PRESET keys to select the shortcut number after Step 2.



“Empty” (not in use) or item currently registered

- 3 To confirm the registration, press MEMORY.



Recalling a registered item

Recall a registered item by selecting the shortcut number.

- 1 Press BLUETOOTH, USB or NET.
- 2 Press PRESET to select a desired content.



- “No Presets” appears when no items are registered.
- The registered item cannot be recalled in the following cases.
 - The USB storage device which contains the registered item is not connected to the unit.
 - The PC/NAS which contains the registered item is turned off or not connected to the network.
 - The registered network content is temporarily unavailable or out of service.
 - The registered item (file) has been deleted or moved to another location.
 - A Bluetooth connection cannot be established.
- When you register music files stored on a USB storage device or a PC/NAS, the unit memorizes the relative position of the music files in the folder. If you have added or deleted any music files to or from the folder, the unit may not recall the music file correctly. In such cases, register the items again.
- The registered content (songs and Internet radio stations) can be displayed as a list and easily recalled by using MusicCast CONTROLLER (p.62) on your mobile device.

Viewing the current status

You can view the current status (input or DSP program currently selected) on the front panel display or TV.

Switching information on the front display

- 1 Press INFO on the front panel to select between the various display items.



Item name

About 3 seconds after a display item is selected, its corresponding information appears.



Information



Available items vary depending on the selected input source. The displayed item can also be applied separately to each input source group.

Currently input source	Item
AV 1-7	
AUX	DSP Program (sound mode name), Audio Decoder (decoder name ^{*1})
AUDIO 1-4	
PHONO	
	(AM radio feature is not available on the Australia, U.K., Europe, Middle East and Russia models)
TUNER (FM/AM)	DSP Program (sound mode name), Audio Decoder (decoder name ^{*1}) * (U.K., Europe, Middle East and Russia models) Radio Data System data is also available when the unit is tuned into a Radio Data System broadcasting station (p.84).
TUNER (DAB)	(Australia, U.K., Europe, Middle East and Russia models only) See "Displaying the DAB information" (p.78) for details.
Bluetooth	Song (song title), Artist (artist name), Album (album name), DSP Program (sound mode name), Audio Decoder (decoder name ^{*1})
USB	
SERVER	Song (song title), Artist (artist name), Album (album name), DSP Program (sound mode name), Audio Decoder (decoder name ^{*1}), IP Address (IP address), Ethernet MAC (Ethernet MAC address), Wi-Fi MAC (Wi-Fi MAC address)
AirPlay	
NET RADIO	Song (song title), Album (album name), Station (station name), DSP Program (sound mode name), Audio Decoder (decoder name ^{*1}), IP Address (IP address), Ethernet MAC (Ethernet MAC address), Wi-Fi MAC (Wi-Fi MAC address)
MusicCast Link	DSP Program (sound mode name), Audio Decoder (decoder name ^{*1}), IP Address (IP address), Ethernet MAC (Ethernet MAC address), Wi-Fi MAC (Wi-Fi MAC address)

^{*1} The name of the audio decoder currently activated is displayed. If no audio decoder is activated, "Decoder Off" appears.

Viewing the status information on the TV

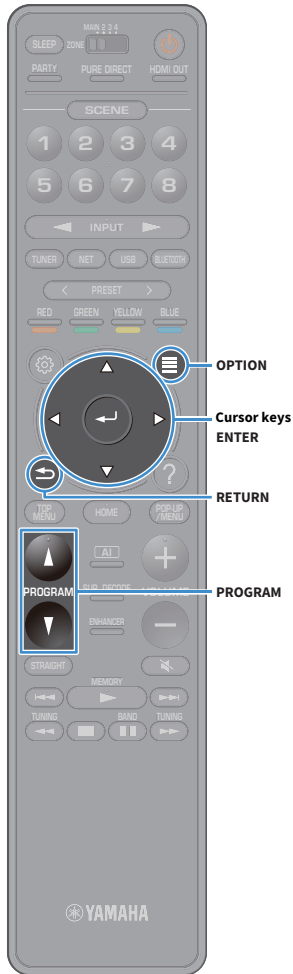

- 1 Press **OPTION**.
- 2 Use the cursor keys to select “On-screen Information” and press **ENTER**.
The following information is displayed on the TV.



When **SURROUND:AI** is enabled, the status information for **SURROUND:AI** is also displayed.

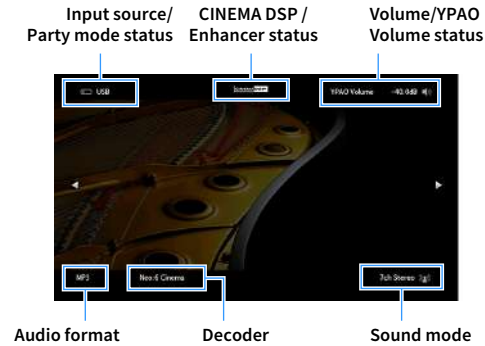

- 3 To close the information display, press **RETURN**.



- You can use the **PROGRAM** key on the remote control for displaying the status information on the TV. For details, see “PROGRAM Key” (p.143).
- Use the left/right cursor keys to display other informations in the “Setup” menu on the TV.

Configuring playback settings for different playback sources (Option menu)

You can configure separate playback settings for different playback sources. This menu is available on the front panel (or on the TV screen), allowing you to easily configure settings during playback.

- 1 Press **OPTION**.

Front display



TV screen



- 2 Use the cursor keys to select an item and press **ENTER**.



To return to the previous screen during menu operations, press **RETURN**.

- 3 Use the cursor keys to select a setting.

- 4 To exit from the menu, press **OPTION**.

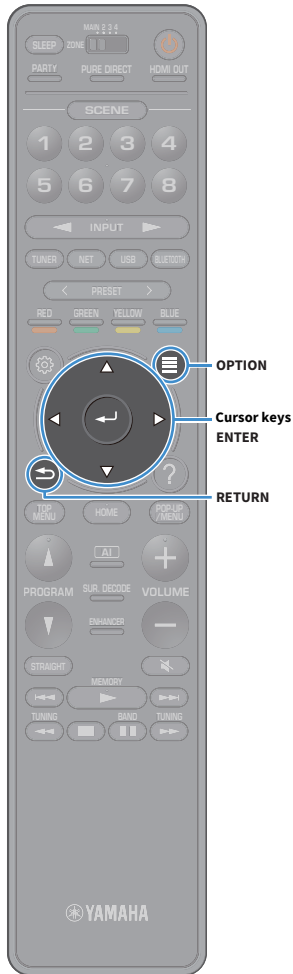

Option menu items



- Available items vary depending on the selected input source.
- When the input icon is displayed on the upper right of the “Option” menu, the setting is applied to the currently selected input source. Otherwise, the setting is applied to all of the input sources.
- Text in parentheses denotes indicators on the front display.
- Default settings are underlined.

Item	Function	Page
Tone Control (Tone Control)	Adjusts the level of high-frequency range and low-frequency range individually.	110
YPAO Volume (YPAO Volume)	YPAO Volume (YPAO Vol.)	Enables/disables YPAO Volume. 110
	Adaptive DRC (A.DRC)	Sets whether the dynamic range (from maximum to minimum) is automatically adjusted when the volume is adjusted. 110
Dialogue (Dialog)	Dialogue Level (Dialog Lvl)	Adjusts the volume of dialogue sounds. 110
	DTS Dialogue Control (DTS Dialog)	Adjusts the volume of dialogue sounds for DTS:X contents. 111
	Dialogue Lift (Dialog Lift)	Adjusts the perceived height of dialogue sounds. 111
Lipsync (Lipsync)	Adjusts the delay between video and audio output. 111	
Enhancer (Enhancer)	Enhancer (Enhancer)	Enables/disables Compressed Music Enhancer. 111
	Hi-Res Mode (HiRes Mode)	Enables/disables the high-resolution mode (for enhancing the quality of uncompressed digital audio). 111
Volume Trim (Volume Trim)	Input Trim (In. Trim)	Corrects volume differences between input sources. 112
	Subwoofer Trim (SW. Trim)	Fine-adjusts the subwoofer volume. 112
Extra Bass (Extra Bass)	Enables/disables Extra Bass. 112	
Audio Select (Audio Select)	Audio Select (A.Sel) Selects the audio signal to be played back. 112	

Item	Function	Page
Video Processing (Video Process.)	Video Mode (V.M)	Enables/disables the video signal processing settings configured in the “Setup” menu. 112
	Video Adjustment (Video Adjust)	Selects a video adjustment setting from presets. 113
Video Out (Video Out)	Video Out (V. Out)	Selects a video to be output with the selected audio source. 113
Shuffle / Repeat (Shuffle/Repeat)	Shuffle (Shuffle)	Configure the shuffle setting for playback. -
	Repeat (Repeat)	Configure the repeat setting for playback. -
FM Mode (FM Mode)	FM Mode (Mode)	Switches between the reception settings for FM radio. 113
Preset (Preset)	FM Auto Preset (FM Auto Preset)	Automatically registers FM radio stations with strong signals as presets. 113
	Clear Preset (Clear Preset)	Clears radio stations registered to preset numbers. 113
	Clear All Preset (ClearAllPreset)	Clears all the radio stations registered to preset numbers. 113
Add to favorites (Add to Fav.)		Adds your favorite Internet radio station to the “Favorites” folder. 114
Remove from favorites (RemovefromFav.)		Removes it from the “Favorites” folder. 114
Init Scan (Init Scan)		(Australia, U.K., Europe, Middle East and Russia models only) Performs an initial scan for DAB radio reception. 76
Tune AID (Tune AID)		(Australia, U.K., Europe, Middle East and Russia models only) Checks reception strength of each DAB channel label. 79
On-screen Information (On-screen Info)		Displays the current status information. 114

Tone Control (Tone Control)

Adjusts the level of high-frequency range (Treble) and low-frequency range (Bass) individually.

Choices

Treble (Treble), Bass (Bass)

Setting range

-6.0 dB to 0.0 dB to +6.0 dB, 0.5 dB increments



- When both “Treble” and “Bass” are 0.0 dB, “Bypass” appears.
- If you set an extreme value, sounds may not match those from other channels.

YPAO Volume (YPAO Volume)

Enables/disables YPAO Volume or Adaptive DRC.

YPAO Volume (YPAO Vol.)

Enables/disables YPAO Volume. When YPAO Volume is enabled, the high- and low-frequency levels are automatically adjusted according to the volume so that you can enjoy natural sounds even at low volume.

Settings

<u>Off (Off)</u>	Disables YPAO Volume.
On (On)	Enables YPAO Volume.



- YPAO Volume works effectively after the measurement results of “YPAO” have been already saved (p.44).
- We recommend enabling both YPAO Volume and Adaptive DRC when you are listening at lower volumes or at night.

Adaptive DRC (A.DRC)

Sets whether the dynamic range (from maximum to minimum) is automatically adjusted when the volume level is adjusted. When it is set to “On”, it is useful for listening to playback at a low volume at night.

Settings

<u>Off (Off)</u>	The dynamic range is not automatically adjusted.
On (On)	Automatically adjusts the dynamic range when YPAO Volume is enabled.

If “On” is selected, the dynamic range becomes narrow at a low volume and wide at a high volume.

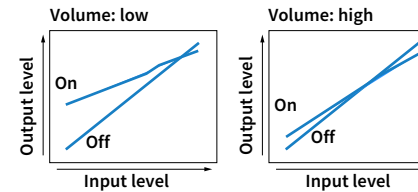

Dialogue (Dialog)

Adjusts the volume or perceive height of dialogue sounds.

Dialogue Level (Dialog Lvl)

Adjusts the volume of dialogue sounds. If dialogue sounds cannot be heard clearly, you can turn up its volume by increasing this setting.

Setting range

0 to 3



This setting is not available when DTS:X content is played back, or when the Dolby Surround or Neural:X decoder is working.

DTS Dialogue Control (DTS Dialog)

Adjusts the volume of dialogue sounds for DTS:X contents.

Setting range

0 to 6



This setting is available only when DTS:X content which supports the DTS Dialogue Control feature is played back.

Dialogue Lift (Dialog Lift)

Adjusts the perceived height of dialogue sounds. If the dialogue sounds as if it is coming from below the TV screen, you can raise its perceived height by increasing this setting.



This setting is available only when one of the following conditions is met.

- One of the sound programs (except for 2ch Stereo and 11ch Stereo) is selected when front presence speakers are used.
- Virtual Presence Speaker (VPS) (p.66) is working.
(You may hear dialogue sounds from the surround speakers depending on the listening position.)

Setting range

0 to 5 (The bigger the value the higher the position)

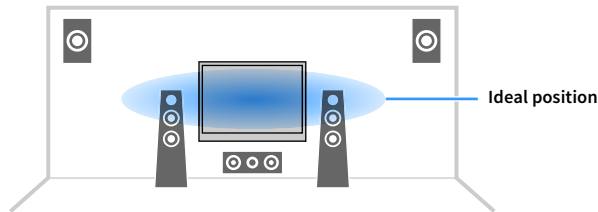

Lipsync (Lipsync)

Adjusts the delay between video and audio output.

Setting range

0 ms to 500 ms (1 ms increments)



This setting is available only when “Delay Enable” (p.126) in the “Setup” menu is set to “Enable” (default).

Enhancer (Enhancer)

Enables/disables Compressed Music Enhancer and the high-resolution mode.

Enhancer (Enhancer)

Enables/disables Compressed Music Enhancer (p.71).



- This setting is applied separately to each input source.
- You can also use ENHANCER on the remote control to enable/disable Compressed Music Enhancer (p.71).

Settings

Off (Off)	Disables Compressed Music Enhancer.
On (On)	Enables Compressed Music Enhancer.

Default

TUNER, Bluetooth, USB, (network sources): On (On)

Others: Off (Off)



Compressed Music Enhancer does not work on the following audio sources.

- Signals whose sampling frequency is over 48 kHz
- DSD audio

Hi-Res Mode (HiRes Mode)

Enables/disables the high-resolution mode when “Enhancer” is set to “On”. If this function is set to “On”, you can enhance the quality of uncompressed digital audio (such as 2-channel PCM and FLAC) using Compressed Music Enhancer.

Settings

On (On)	Enables the high-resolution mode. (The high-resolution mode may not work depending on the audio signal processing condition.)
Off (Off)	Disables the high-resolution mode.

■ Volume Trim (Volume Trim)

Configures the input settings.

Input Trim (In.Trim)

Corrects volume differences between input sources. If you are bothered by volume differences when switching between input sources, use this function to correct it.

Setting range

-6.0 dB to 0.0 dB to +6.0 dB (0.5 dB increments)

Subwoofer Trim (SW.Trim)

Fine-adjusts the subwoofer volume.

Setting range

-6.0 dB to 0.0 dB to +6.0 dB (0.5 dB increments)

■ Extra Bass (Extra Bass)

Enables/disables Extra Bass. When Extra Bass is enabled, you can enjoy enhanced bass sounds, regardless of the size of the front speakers and the presence or absence of the subwoofer.

Settings

<u>Off (Off)</u>	Disables Extra Bass.
On (On)	Enables Extra Bass.

■ Audio Select (Audio Select)

Selects the audio signal to be played back.

Audio Select (A.Sel)

Selects the audio input jack to use when more than one audio connection is made for one input source.

Settings

	Automatically selects the audio input jack in the following priority order. 1. HDMI input 2. Digital input (COAXIAL or OPTICAL) 3. Analog input (AUDIO)
<u>Auto (Auto)</u>	
HDMI (HDMI)	Always selects HDMI input. No sounds are produced when no signals are input through the HDMI jack.
COAX/OPT (COAX/OPT)	Always selects digital input (COAXIAL or OPTICAL). No sounds are produced when no signals are input through the COAXIAL or OPTICAL jack.
Analog (Analog)	Always selects analog input (AUDIO). No sounds are produced when no signals are input through the AUDIO jacks.

■ Video Processing (Video Process.)

Enables/disables the video signal processing (resolution and aspect ratio) settings configured in “Resolution” and “Aspect” (p.133) in the “Setup” menu.

Configures the video signal processing settings.

Video Mode (V.M)

Enables/disables the video signal processing (resolution, aspect ratio and video adjustments) settings configured in “Processing” (p.132) in the “Setup” menu.

Settings

<u>Direct (Direct)</u>	Disables the video signal processing.
Processing (Processing)	Enables the video signal processing.

Video Adjustment (Video Adjust)

Selects a video adjustment setting from presets you have configured in “Adjustment” (p.133) in the “Setup” menu.



This setting is applied separately to each input source.

Settings

1 to 6

Video Out (V.Out)

Selects a video to be output with the audio input source.

Settings

<u>Off (Off)</u>	Does not output video.
AV 1-7 (AV1-7)	Outputs video input through the corresponding video input jacks.

Shuffle / Repeat (Shuffle/Repeat)

Configures the Shuffle settings or repeat settings.

Shuffle (Shuffle)

Configures the shuffle setting for the USB storage device (p.86) or media server (p.90).

Settings

<u>Off (Off)</u>	Turns off the shuffle function.
On (On)	Plays back songs in the current album (folder) in random order.

Repeat (Repeat)

Configures the repeat setting for the USB storage device (p.86) or media server (p.90).

Settings

<u>Off (Off)</u>	Turns off the repeat function.
One (One)	Plays back the current song repeatedly.
All (All)	Plays back all songs in the current album (folder) repeatedly.

FM Mode (FM Mode)

Switches between the reception settings for FM radio.

FM Mode (Mode)

Switches between stereo and monaural for FM radio reception.

Settings

<u>Stereo (Stereo)</u>	Receives FM radio in stereo sounds.
Monaural (Monaural)	Receives FM radio in monaural sounds.

Preset (Preset)

Registers radio stations or clears preset stations.

FM Auto Preset (FM Auto Preset)

Automatically registers FM radio stations with strong signals as presets.



- You can register up to 40 radio stations as presets.
- (U.K., Europe, Russia and Middle East models only)
Only Radio Data System broadcasting stations are stored automatically by “FM Auto Preset”.

Clear Preset (Clear Preset)

Clears radio stations registered to preset numbers.

Clear All Preset (ClearAllPreset)

Clears all the radio stations registered to preset numbers.

Settings

<u>Cancel</u>	Cancel the unregistering of a radio station.
Execute	Removes all registered radio stations.

■ **Add to favorites (Add to Fav.)**

Register the currently playing Internet radio station to the “Favorites” folder.



You can also register up to 40 favorite USB and network contents or Bluetooth input source as shortcuts (p.105).

■ **Remove from favorites (RemovefromFav.)**

Remove an Internet radio station from the “Favorites” folder.

■ **Init Scan (Init Scan)**

Initiate Scan specifies the initial settings in order to receive DAB radio. If this operation is not performed, not all DAB-related functions can be used.

■ **Tune AID (Tune AID)**

From the “Tune Aid” menu , you can check the reception level of each channel.

■ **On-screen Information (On-screen Info)**

Displays the current status information.

CONFIGURATIONS

Configuring various functions (Setup menu)

Perform the following basic procedure to operate the “Setup” menu. You can configure the unit’s various functions with the “Setup” menu.



- If new firmware is available, the message screen appears.
- If new firmware is available, the envelope icon (✉) appears at the lower of the “Setup” menu.

1 Press SETUP.

2 Use the cursor keys to select a menu and press ENTER.

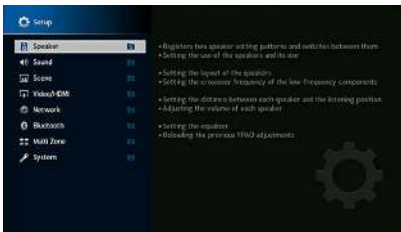

3 Use the cursor keys to select an item and press ENTER.

4 Use the cursor keys to select a setting.

5 Press SETUP.

This completes the settings.

Setup menu items

Use the following table to configure various functions of the unit.

Menu	Item	Function	Page	
Speaker	Setting Pattern	Registers two speaker setting patterns and switches between them.	121	
	Setting Data Copy	Copies the “Setting Pattern” parameters in the specified direction.	121	
	Configuration	Front	Selects the size of the front speakers.	121
		Center	Selects whether or not a center speaker is connected and its size.	122
		Surround	Selects whether or not surround speakers are connected and their size.	122
		Surround Back	Selects whether or not surround back speakers are connected and their size.	122
		Front Presence	Selects whether or not front presence speakers are connected and their size.	122
		Rear Presence	Selects whether or not rear presence speakers are connected and their size.	123
		Subwoofer	Selects whether or not a subwoofer is connected.	123
	Distance	Sets the distance between each speaker and listening position.	123	
	Level	Adjusts the volume of each speaker.	123	
	Parametric EQ	Adjusts the tone with an equalizer.	124	
	Test Tone	Enables/disables the test tone output.	125	
	YPAO Result	Checks and Reloads the previous YPAO adjustments.	125	

Menu	Item	Function	Page	
Sound	Information	Displays information about the current audio signal.	125	
	Lipsync	Delay Enable	Enables/disables the “Lipsync” adjustment configured in “Auto/Manual Select” in the “Setup” menu.	126
		Auto/Manual Select	Selects the method to adjust the delay between video and audio output.	126
	DSP Parameter	Adjustment	Adjusts the delay between video and audio output manually.	126
		DSP Level	Adjusts the sound field effect level.	126
		Initial Delay	Adjusts the delay between the direct sound and presence sound field generation.	127
		Room Size	Adjusts the broadening effect of the presence sound field.	127
		Liveness	Adjusts the loss of the presence sound field.	127
		Reverb Time	Adjusts the decay time of the rear reverberant sound.	127
		Reverb Delay	Adjusts the delay between the direct sound and reverberant sound generation.	127
		Reverb Level	Adjusts the volume of the reverberant sound.	127
		Surround Initial Delay	Adjusts the delay between the direct sound and surround sound field generation.	127
		Surround Room Size	Adjusts the broadening effect of the surround sound field.	128
		Surround Liveness	Adjusts the loss of the surround sound field.	128
		Surround Back Initial Delay	Adjusts the delay between the direct sound and surround back sound field generation.	128
		Surround Back Room Size	Adjusts the broadening effect of the surround back sound field.	128
		Surround Back Liveness	Adjusts the loss of the surround back sound field.	128
		Surround Decoder	Decode Type	Selects a surround decoder to be used in combination with the selected sound program.
	Center Spread		Selects whether to spread the center channel signals to left and right when 2-channel source is played.	128
	Center Image		Adjusts the center localization (broadening effect) of the front sound field.	128
	11ch Stereo	Level	Adjusts the entire volume.	129
		Front / Rear Balance	Adjusts the front and rear volume balance.	129
		Left / Right Balance	Adjusts the left and right volume balance.	129
		Height Balance	Adjusts the height volume balance using the presence speakers.	129
		Monaural Mix	Enables/disables monaural sound output.	129
		Reset	Restores all default settings.	129
	Dynamic Range	Selects the dynamic range adjustment method for bitstream audio (Dolby Digital and DTS signals) playback.	129	
	Volume	Max Volume	Sets the limit value of the volume.	130
		Initial Volume	Sets the initial volume for when this receiver is turned on.	130
	Pure Direct Mode	Selects whether to output video signals during the Pure Direct mode.	130	
	Adaptive DSP Level	Selects whether to automatically adjust the CINEMA DSP 3D effect level when the volume is adjusted.	130	
	Virtual Speaker	VPS	Selects whether to create Virtual Presence Speaker (VPS) using the front, center, and surround speakers.	130
VSBS		Selects whether to create Virtual Surround Back Speaker (VSBS) using the surround speakers.	130	
Ultra Low Jitter PLL Mode	Enables/disables the jitter elimination function.	131		
DAC Digital Filter	Selects the digital filter type of the audio DAC (digital-to-analog converter).	131		
Balance Input Attenuator	Selects whether to activate the attenuator for the balance input to avoid sound distortion.	131		

Menu	Item	Function	Page	
Scene	Scene Setting	Selects items to be included as the scene assignments.	131	
	Scene Rename	Renames the scene name displayed on the front display or TV screen.	132	
Video/HDMI	Information	Displays information about the current video signal and the TVs connected to the HDMI OUT jacks.	132	
	Video Mode	Video Mode	Enables/disables the video signal processing.	132
		Resolution	Selects a resolution to output HDMI video signals.	133
		Aspect	Selects an aspect ratio to output HDMI video signals.	133
		Adjustment	Configures the video adjustments.	133
	HDMI Control	HDMI Control	Enables/disables HDMI Control.	134
		TV Audio Input	Selects an audio input jack of the unit to be used for TV audio input.	134
		ARC	Enables/disables ARC.	134
		Standby Sync	Selects whether to use HDMI control to link the standby behavior of the TV and the unit.	134
	HDMI Audio Output	Enables/disables the audio output from a TV.	134	
	HDMI ZONE OUT Assign	Select the zone for which the HDMI OUT 3 (ZONE OUT) jack is used.	134	
	HDCP Version	Selects the version of HDCP used on the HDMI input jacks.	135	
	HDMI Standby Through	Selects whether to output videos/audio (input through HDMI jacks) to the TV when the unit is in standby mode.	135	
	Network	Information	Displays the network information on the unit.	135
Network Connection		Selects the network connection method.	136	
IP Address		Configures the network parameters (such as IP address).	136	
Network Standby		Selects whether to enable/disable the function that turns on the unit from other network devices.	136	
MAC Address Filter		Sets the MAC address filter to limit access to the unit from other network devices.	137	
DMC Control		Selects whether to allow a Digital Media Controller (DMC) to control playback.	137	
AirPlay Volume Interlock		Enables/disables volume controls from iTunes/iPhone via AirPlay.	137	
Network Name		Edits the network name (the unit's name on the network) displayed on other network devices.	138	
MusicCast Link Power Interlock		Selects whether turning on the power of the master device of the MusicCast network (this unit) also turns on the power of other devices of the network.	138	
Bluetooth		Bluetooth	Enables/disables the Bluetooth functions.	138
	Audio Receive	Disconnect	Terminates the Bluetooth connection between the Bluetooth device (such as smartphones) and the unit.	139
		Bluetooth Standby	Selects whether to enable/disable the function that turns on the unit from Bluetooth devices (Bluetooth standby).	139

Menu	Item	Function	Page	
Multi Zone	Information	Displays information about Zone2, Zone3 and Zone4	139	
	Zone2	Volume	Enables/disables volume adjustments for Zone2 output.	139
		Max Volume	Sets the Zone2 limit value of the volumes.	140
		Initial Volume	Sets the Zone2 initial volume for when the unit is turned on.	140
		Audio Delay	Adjusts the audio output timing for Zone2.	140
		Monaural	Switches between stereo and monaural for Zone2 output.	140
		Enhancer	Enables/disables Compressed Music Enhancer for Zone2 output.	140
		Tone Control	Adjusts the level of high-frequency range and low-frequency range for Zone2 output.	140
		Extra Bass	Enables/disables Extra Bass for Zone2 output.	140
	Left / Right Balance	Adjusts the volume balance for Zone2 output.	140	
	Zone3	Volume	Enables/disables volume adjustments for Zone3 output.	139
		Max Volume	Sets the Zone3 limit value of the volumes.	140
		Initial Volume	Sets the Zone3 initial volume for when the unit is turned on.	140
		Audio Delay	Adjusts the audio output timing for Zone3.	140
		Monaural	Switches between stereo and monaural for Zone3 output.	140
Enhancer		Enables/disables Compressed Music Enhancer for Zone3 output.	140	
Tone Control		Adjusts the level of high-frequency range and low-frequency range for Zone3 output.	140	
Extra Bass		Enables/disables Extra Bass for Zone3 output.	140	
Left / Right Balance	Adjusts the volume balance for Zone3 output.	140		
Zone Rename	Changes the zone name displayed on the TV screen.	141		
Party Mode Set	Enables/disables switching to the party mode.	141		

Menu	Item	Function	Page	
System	Information	Displays the system information on the unit.	141	
	Language	Selects an on-screen menu language.	141	
	Input Assignment	Assigns the COMPONENT VIDEO, COAXIAL and OPTICAL jacks to another input source.	142	
	Input Skip	Sets which input source is skipped when operating the INPUT key.	142	
	Input Rename	Changes the input source name displayed on the front display.	142	
	Auto Play	Enables/disables Auto Play function in Internet radio services.	143	
	DSP Skip	Sets which sound programs are skipped when operating the PROGRAM key.	143	
	Remote Key	PROGRAM Key	Sets the function for the PROGRAM key on the remote control.	143
		Color Key	Set the unit's functions for the RED/GREEN/YELLOW/BLUE key of the remote control.	144
	Display Set	Dimmer (Front Display)	Adjusts the brightness of the front display.	144
		Volume	Switches the scale of the volume display.	144
		Short Message	Selects whether to display short messages on the TV screen when the unit is operated.	144
		Wallpaper	Selects the image to be used as wallpaper on the TV screen.	144
		Trigger Output1	Trigger Mode	Specifies the condition for the TRIGGER OUT 1 jack to function.
	Target Zone		Specifies the zone with which the TRIGGER OUT 1 jack functions are synchronized.	145
	Trigger Output2	Trigger Mode	Specifies the condition for the TRIGGER OUT 2 jack to function.	145
		Target Zone	Specifies the zone with which the TRIGGER OUT 2 jack functions are synchronized.	145
	ECO	Auto Power Standby	Sets the amount of time for the auto-standby function.	146
	Memory Guard		Prevents accidental changes to the settings.	146
	Firmware Update		Updates the firmware via the network.	147

Speaker

Configures the speaker settings manually.



Default settings are underlined.



Setting Pattern

Registers two speaker setting patterns and switches between them.

When you configure the following speaker settings, the settings will be memorized in the selected pattern.

- Configuration
- Distance
- Level
- Parametric EQ
- YPAO Result

Settings

Pattern1, Pattern2



- The setting pattern currently selected is shown at the center of the diagram on the right side of the screen.
- This function is useful when you want to save certain settings according to the varying conditions of your listening environment. For example, if you want to switch the settings when curtains are open or closed, you can save the settings suited for each condition and switch between them.

Setting Data Copy

Copies the “Setting Pattern” parameters in the specified direction.

Choices

Pattern1 ▶ 2	Copies the “Pattern1” parameters to “Pattern2”.
Pattern2 ▶ 1	Copies the “Pattern2” parameters to “Pattern1”.

Configuration

Configures the output characteristics of the speakers.



- When you configure the speaker size, select “Large” if the woofer diameter of your speaker is 16 cm (6-1/4”) or larger or “Small” if it is smaller than 16 cm (6-1/4”) as a guide.
- When the speaker size is set to “Small”, you can configure the “Crossover”. Frequency sounds lower than the specified value will be output from the subwoofer and higher will be output from the corresponding speakers.

Front

Selects the size of the front speakers.

Settings

<u>Large</u>	Select this option for large speakers. The front speakers will produce all of the front channel frequency components.
<u>Small</u>	Select this option for small speakers. The subwoofer will produce front channel low-frequency components lower than the specified crossover frequency (default: 80 Hz).



“Front” is automatically set to “Large” when both “Subwoofer 1” and “Subwoofer 2” are set to “None”.

Center

Selects whether or not a center speaker is connected and its size.

Settings

Large	Select this option for large speakers. The center speaker will produce all of the center channel frequency components.
<u>Small</u>	Select this option for small speakers. The subwoofer or front speakers will produce center channel low-frequency components lower than the specified crossover frequency (default: 80 Hz).
None	Select this option when no center speaker is connected. The front speakers will produce center channel audio.

Surround

Selects whether or not surround speakers are connected and their sizes and layout.

Settings

Large	Select this option for large speakers. The surround speakers will produce all of the surround channel frequency components.
<u>Small</u>	Select this option for small speakers. The subwoofer or front speakers will produce surround channel low-frequency components lower than the specified crossover frequency (default: 80 Hz).
None	Select this option when no surround speakers are connected. The front speakers will produce surround channel audio. Virtual CINEMA DSP works when you select a sound program.

Layout Settings

<u>Rear</u>	Select this option when surround speakers are placed on the rear side of the room.
Front	Select this option when surround speakers are placed on the front side of the room. Virtual CINEMA FRONT works in this case.



This setting is not available when “Configuration (Surround)” is set to “None”.

Surround Back

Selects whether or not surround back speakers are connected and their sizes.

Settings

Large	Select this option when large speakers are connected. The surround back speakers will produce all of the surround back channel frequency components.
<u>Small</u>	Select this option when small speakers are connected. The subwoofer or front speakers will produce surround back channel low-frequency components lower than the specified crossover frequency (default: 80 Hz).
None	Select this option when no surround back speakers are connected. The surround speakers will produce surround back channel audio.



This setting is not available when “Surround” is set to “None”, or when “Layout (Surround)” is set to “Front”.

Front Presence

Selects whether or not front presence speakers are connected and their size and layout.

Settings

Large	Select this option for large speakers.
<u>Small</u>	Select this option for small speakers. The subwoofer or front speakers will produce front presence channel low-frequency components lower than the specified crossover frequency (default: 80 Hz).
None	Select this option when no front presence speakers are connected.

Layout Settings

<u>Front Height</u>	Select this option when front presence speakers are installed on the front side wall.
Overhead	Select this option when front presence speakers are installed to the ceiling.
Dolby Enabled SP	Select this option when using the Dolby Enabled speakers as the front presence speakers.



- This setting is not available when “Configuration (Front Presence)” is set to “None”.
- To play Dolby Atmos contents using the presence speakers, see “Presence speaker layout” (p.26).

Rear Presence

Selects whether or not rear presence speakers are connected and their size.

Settings

Large	Select this option for large speakers.
	Select this option for small speakers.
Small	The subwoofer or front speakers will produce rear presence channel low-frequency components lower than the specified crossover frequency (default: 80 Hz).
None	Select this option when no rear presence speakers are connected.

Layout Settings

Rear Height	Select this option when rear presence speakers are installed on the rear side wall.
Overhead	Select this option when rear presence speakers are installed to the ceiling.
Dolby Enabled SP	Select this option when using the Dolby Enabled speakers as the rear presence speakers.



This setting is not available when “Surround” or “Front Presence” is set to “None”.

Subwoofer

Selects whether or not a subwoofer is connected to the SUBWOOFER 1 or SUBWOOFER 2 jack and its phase.

Settings

	<u>Normal</u>	Select this option when a subwoofer is connected to the SUBWOOFER 1 or SUBWOOFER 2 jack (phase not reversed). The subwoofer will produce LFE (low-frequency effect) channel audio and low-frequency components from other channels.
Use	Reverse	Select this option when a subwoofer is connected to the SUBWOOFER 1 or SUBWOOFER 2 jack (phase reversed). The subwoofer will produce LFE (low-frequency effect) channel audio and low-frequency components from other channels.
None		Select this option when no subwoofer is connected to the SUBWOOFER 1 or SUBWOOFER 2 jack. The front speakers will produce LFE (low-frequency effect) channel audio and low-frequency components from other channels when both “Subwoofer 1” and “Subwoofer 2” are set to “None”.



When the bass sound is lacking or unclear, switch the subwoofer phase.

Layout settings

Left + Right	Select this option when 2 subwoofers are placed on the left and right sides of the room.
Front + Rear	Select this option when 2 subwoofers are placed on the front and rear sides of the room.
<u>Monaural x2</u>	Select this option when 2 subwoofers are placed freely.



This setting is not available when “Subwoofer 1” or “Subwoofer 2” is set to “None”.

Distance

Sets the distance between each speaker and listening position so that sounds from the speakers reach the listening position at the same time. First, select the unit of distance from “Meter” or “Feet”.

Choices

Front L, Front R, Center, Surround L, Surround R, Surround Back L, Surround Back R, Front Presence L, Front Presence R, Rear Presence L, Rear Presence R, Subwoofer 1, Subwoofer 2

Setting range

0.30 m to 3.00 m to 24.00 m (1.0 ft to 10.0 ft to 80.0 ft), 0.05 m (0.2 ft) increments

Level

Adjusts the volume of each speaker.

Choices

Front L, Front R, Center, Surround L, Surround R, Surround Back L, Surround Back R, Front Presence L, Front Presence R, Rear Presence L, Rear Presence R, Subwoofer 1, Subwoofer 2

Setting range

-10.0 dB to 0.0 dB to +10.0 dB (0.5 dB increments)

Parametric EQ

Adjusts the tone with an equalizer.

Settings

Manual	Select this option when you want to adjust the equalizer manually. For details, see “Manual equalizer adjustment”.
YPAO:Flat	Adjusts individual speakers to achieve the same characteristics.
YPAO:Front	Adjusts individual speakers to achieve the same characteristics as the front speakers.
YPAO:Natural	Adjusts all speakers to achieve a natural sound.
Through	Does not use the equalizer.



“YPAO:Flat”, “YPAO:Front”, and “YPAO:Natural” are available only when the measurement results of “YPAO” have already been saved (p.44). Press ENTER again to view the measurement results.

Manual equalizer adjustment

- 1 Set “Parametric EQ” to “Manual” and press ENTER.
- 2 Press ENTER again to enter the edit screen.
- 3 Use the cursor keys to select a speaker and press ENTER.



- To restore the default settings for all speakers, use the cursor keys to select “PEQ Data Clear”, press ENTER, and then select “OK”.
- To copy the parametric equalizer values acquired with “YPAO” (p.44) to the “Manual” fields for fine adjustment, select “PEQ Data Copy” and then an equalizer type.

- 4 Use the cursor keys to select a center frequency from the 7 preset bands (4 for subwoofer).



- 5 To fine-adjust the center frequency, Q factor (bandwidth) or gain, use the cursor keys to select an item.

Freq.: Use the cursor keys to adjust the center frequency of the selected band.

Q: Use the cursor keys to adjust the Q factor (bandwidth) of the selected band.

Gain: Use the cursor keys to adjust the gain of the selected band.

Setting range

Center frequency: 15.6 Hz to 16.0 kHz (15.6 Hz to 250.0 Hz for subwoofer)

Q factor: 0.500 to 10.080

Gain: -20.0 dB to +6.0 dB

- 6 To exit from the menu, press SETUP.

Test Tone

Enables/disables the test tone output. Test tone output helps you to adjust the speaker balance or equalizer while confirming its effect.

Settings

Off	Does not output test tones.
On	Outputs test tones automatically when you adjust the speaker balance or equalizer.

YPAO Result

You can check the previous YPAO adjustments (“Wiring”, “Size”, “Distance”, “Level”, “Angle (horizontal)” and “Height”) in “YPAO Result”.

When the speaker settings you have configured manually are not suitable, you can discard the manual settings and reload the previous YPAO adjustments.

Reloading the previous YPAO adjustments

- 1 Use the cursor keys to select “Setup Reload”.
- 2 Press ENTER.
- 3 Press SETUP.

Sound

Configures the audio output settings.

Information

Displays information about the current audio signal.

Choices

	Format	Audio format of the input signal
	Channel	The number of source channels in the input signal (front/surround/LFE) For example, “5.1 (3/2/0.1)” means 5.1ch in total (3 front channels, 2 surround channels, and LFE).
Input	Channel	(When DTS:X content is played back) For example, “7.1.4” denotes “standard 7.1-channel plus 4 for overhead speaker channels”.
	Sampling	The number of samples per second of the input digital signal
	Dialogue	The dialogue normalization level of the input bitstream signal
Output	Channel	The number of signal output channels (for example, “5.1.2” denotes “standard 5.1-channel plus 2 for overhead speaker channels”) and the Speaker channels from which signals are output



Even when the unit is set to output bitstream signals directly, the signal may be converted depending on the specifications and settings of the playback device.



Lipsync

Adjusts the delay between video and audio by holding up the audio output.

Delay Enable

Enables/disables the Lipsync adjustment for each input source.

Choices

AV 1-7, AUX, AUDIO 1-4

Settings

Disable	Disable the Lipsync adjustment for the selected input source.
Enable	Enables the Lipsync adjustment for the selected input source.

Auto/Manual Select

Selects the method to adjust the delay between video and audio output.

Setting range

Auto	Adjusts the delay between video and audio output automatically when a TV that supports an automatic lipsync function is connected to the unit via HDMI. If necessary, you can fine-adjust the audio output timing in "Adjustment".
Manual	Select this option when you want to adjust the delay between video and audio output manually. Adjust the audio output timing in "Adjustment".



Even if "Auto/Manual Select" is set to "Auto", the automatic adjustment does not work depending on the TV connected to the unit. In this case, adjust the delay manually in "Adjustment".

Adjustment

Adjusts the delay between video and audio output manually when "Auto/Manual Select" is set to "Manual". You can fine-adjust the audio output timing when "Auto/Manual Select" is set to "Auto".



Setting range

0 ms to 500 ms (1 ms increments)



- When "Auto/Manual Select" is set to "Auto", "Offset" shows the difference between automatic adjustment and fine adjustment.
- This setting is also available in "Lipsync" (p.111) in the "Option" menu.

DSP Parameter

Selects the sound program to change the settings of the sound program.

DSP Level

Adjusts the sound field effect level. Higher to enhance the sound field effect, and lower to reduce it.

Setting range

-6 dB to +3 dB



- Available items vary depending on the selected sound program.
- To restore the default settings for the selected sound program, select "Reset".

Initial Delay

Adjusts the delay between the direct sound and presence sound field generation. Higher to enhance the delay effect, and lower to reduce it.

Setting range

1 ms to 99 ms



- Available items vary depending on the selected sound program.
- To restore the default settings for the selected sound program, select “Reset”.

Room Size

Adjusts the broadening effect of the presence sound field.

Setting range

0.1 to 2.0 (higher to enhance the broadening effect)



- Available items vary depending on the selected sound program.
- To restore the default settings for the selected sound program, select “Reset”.

Liveness

Adjusts the loss of the presence sound field.

Setting range

0 to 10 (higher to enhance the reflectivity)



- Available items vary depending on the selected sound program.
- To restore the default settings for the selected sound program, select “Reset”.

Reverb Time

Adjusts the decay time of the rear reverberant sound. Higher to enrich the reverberant sound and lower to have clear sound.

Setting range

1.0 s to 5.0 s



- Available items vary depending on the selected sound program.
- To restore the default settings for the selected sound program, select “Reset”.

Reverb Delay

Adjusts the delay between the direct sound and reverberant sound generation. Higher to enhance the delay effect, and lower to reduce it.

Setting range

0 ms to 250 ms



- Available items vary depending on the selected sound program.
- To restore the default settings for the selected sound program, select “Reset”.

Reverb Level

Adjusts the volume of the reverberant sound. Higher to strengthen the reverberant sound, and lower to weaken it.

Setting range

0 % to 100 %



- Available items vary depending on the selected sound program.
- To restore the default settings for the selected sound program, select “Reset”.

Surround Initial Delay

Adjusts the delay between the direct sound and surround sound field generation. Higher to enhance the delay effect, and lower to reduce it.

Setting range

1 ms to 49 ms



- Available items vary depending on the selected sound program.
- To restore the default settings for the selected sound program, select “Reset”.

Surround Room Size

Adjusts the broadening effect of the surround sound field.

Setting range

0.1 to 2.0 (higher to enhance the broadening effect)



- Available items vary depending on the selected sound program.
- To restore the default settings for the selected sound program, select “Reset”.

Surround Liveness

Adjusts the loss of the surround sound field.

Setting range

0 to 10 (higher to enhance the reflectivity)



- Available items vary depending on the selected sound program.
- To restore the default settings for the selected sound program, select “Reset”.

Surround Back Initial Delay

Adjusts the delay between the direct sound and surround back sound field generation.

Higher to enhance the delay effect, and lower to reduce it.

Setting range

1 ms to 49 ms



- Available items vary depending on the selected sound program.
- To restore the default settings for the selected sound program, select “Reset”.

Surround Back Room Size

Adjusts the broadening effect of the surround back sound field.

Setting range

0.1 to 2.0 (higher to enhance the broadening effect)



- Available items vary depending on the selected sound program.
- To restore the default settings for the selected sound program, select “Reset”.

Surround Back Liveness

Adjusts the loss of the surround back sound field.

Setting range

0 to 10 (higher to enhance the reflectivity)



- Available items vary depending on the selected sound program.
- To restore the default settings for the selected sound program, select “Reset”.

Surround Decoder

Configures the surround decoders settings.

Decode Type

Selects a surround decoder to be used in combination with the selected sound program.

Choices

Auto, Dsur, Neural:X, Neo:6 Cinema, Neo:6 Music

Center Spread

Selects whether to spread the center channel signals to left and right when a 2channel source is played. This setting is effective when “ Dsur” is selected.

Settings

<u>Off</u>	Disables Center Spread.
On	Enables Center Spread.



If you feel the center sound is too strong, set this function to “On”.

Center Image

Adjusts the center localization (broadening effect) of the front sound field. Adjust this higher to strengthen the center localization (less broadening effect) or lower to weaken it (more broadening effect). This setting is effective when “Neo:6 Music” is selected.

Setting range

0.0 to 0,3 to 1.0

11ch Stereo

Adjusting the volume settings.

Level

Adjusts the entire volume. This setting is effective when “11ch Stereo” is selected.

Setting range

-5 to 0 to 5

Front / Rear Balance

Adjusts the front and rear volume balance. Higher to enhance the front side, and lower to enhance the rear side. This setting is effective when “11ch Stereo” is selected.

Setting range

-5 to 0 to 5

Left / Right Balance

Adjusts the left and right volume balance. Higher to enhance the right side, and lower to enhance the left side. This setting is effective when “11ch Stereo” is selected.

Setting range

-5 to 0 to 5

Height Balance

Adjusts the height volume balance using the presence speakers. Higher to enhance the upside, and lower to enhance the downside. This setting is effective when “11ch Stereo” is selected.

Setting range

0 to 5 to 10



The presence speakers do not produce sounds when “Height Balance” is set to “0”.

Monaural Mix

Enables/disables monaural sound output. This setting is effective when “11ch Stereo” is selected.

Settings

<u>Off</u>	Disables monaural sound output.
On	Enables monaural sound output.

Reset

Restores all default settings.

Dynamic Range

Selects the dynamic range adjustment method for bitstream audio (Dolby Digital and DTS signals) playback.

Settings

<u>Maximum</u>	Produces audio without adjusting the dynamic range.
Standard	Optimizes the dynamic range for regular home use.
Minimum/Auto	Sets the dynamic range for clear sound even at night or at low volumes. When playing back Dolby TrueHD signals, the dynamic range is automatically adjusted based on the input signal information.

Volume

Setting the volume.

Max Volume

Sets the limit value of the volume.

Setting range

-60.0 dB to +15.0 dB (5.0 dB increments), +16.5 dB [20.5 to 95.5 (5.0 increments), 97.0]

Initial Volume

Sets the initial volume when the receiver is turned on.

Settings

<u>Off</u>	Sets the level to the volume level of the unit when it last entered standby mode.
On	Sets at Mute or the specified volume level (-80.0 dB to +16.5 dB, 0.5 dB increments) [0.5 to 97.0 (0.5 increments)]. (Specify a volume level which is lower than the “Max Volume” setting.)

Pure Direct Mode

Selects whether to output video signals during the Pure Direct mode (p.71).

Settings

<u>Auto</u>	Automatically outputs video signals when any videos are input from the selected input source or an input source that can be operated with the on-screen display is selected. When no video signals are input, the wall paper is displayed.
Video Off	Does not output video signals including the wall paper.

Adaptive DSP Level

Selects whether to automatically adjust the CINEMA DSP effect level.

Settings

Off	Does not adjust the effect level automatically.
<u>On</u>	Adjusts the effect level automatically according to the YPAO measurement results and the volume level.

Virtual Speaker

Setting Virtual Speaker.

VPS

Selects whether to create Virtual Presence Speaker (VPS) using the front, center, and surround speakers. When VPS is enabled, the unit creates front VPS when no front presence speakers are connected, and creates rear VPS when front presence speakers are connected but no rear presence speakers (p.66).

Settings

Off	Disables Virtual Presence Speaker (VPS).
<u>On</u>	Enables Virtual Presence Speaker (VPS).



Depending on the installation height of the surround speakers, VPS may not be effective. In this case, set “Virtual Presence Speaker” to “Off”.

VSBS

Selects whether to create Virtual Surround Back Speaker (VSBS) using the surround speakers. When VSBS is enabled, the unit creates VSBS when no surround back speakers are connected.

Settings

Off	Disables Virtual Surround Back Speaker (VSBS).
<u>On</u>	Enables Virtual Surround Back Speaker (VSBS).



VSBS is effective only when 6.1- or 7.1-channel content is played back.

Ultra Low Jitter PLL Mode

Enables/disables the jitter elimination function.

Input source

AV 1-7, AUDIO 1-4 (available only when any audio digital input jack is assigned), (network sources), Bluetooth, USB

Settings

Off	Disables the jitter elimination function.
	Enables the jitter elimination function.
<u>Level 1</u> , Level 2, Level 3	The higher level enhances the DAC accuracy, but may cause audio interruptions on some playback devices depending on the audio clock conditions. In this case, select lower level.

DAC Digital Filter

Selects the digital filter type of the audio DAC (digital-to-analog converter) to have favorite sounds.

Settings

Sharp Roll-off Type	Removes out-of-band noises by the filter with steep attenuation characteristics. It has a tendency to produce clear sounds.
Slow Roll-off Type	Removes out-of-band noises by the filter with gentle attenuation characteristics. It has a tendency to produce soft sounds.
<u>Short Latency Type</u>	Reduces the audio delay caused by the DAC internal digital filter. It has a tendency to produce responsive and rhythmical sounds.

Balance Input Attenuator

Selects whether to activate the attenuator for the balance input (AUDIO 4) so that you can avoid sound distortion when high-level signals are input.

Activate the attenuator when connecting an audio device which outputs signals of 3 V (RMS) or higher to the AUDIO 4 (XLR balanced input) jacks (p.36).

Input source

AUDIO 4

Settings

<u>Bypass</u>	Does not activate the attenuator for the balance input.
ATT.(-6dB)	Activates the attenuator for the balance input to reduce the signal level (-6dB).

Scene

Configures the scene settings.

Scene Setting

Selects items to be included as the scene assignments. You can also view the settings currently assigned to the selected scene.



The scene assignments can include radio stations, or the content on a selected USB storage device, Bluetooth device, and network device.

Procedure

- 1 Use the cursor keys to select the SCENE name and press ENTER.
- 2 To include items as the scene assignments, use the cursor keys to select an item and press ENTER to check the box (or uncheck the box to exclude).



Choices

HDMI Control	Control Sync (HDMI Control (p.134))
Input	Input (p.63), Audio Select (p.112)
	[Input sources: TUNER, (network sources), SERVER, NET RADIO, Bluetooth, USB]
Registered Content	Station, Music Content [Input sources: others] ---
HDMI Output	HDMI Output (p.63)
Mode	DSP Program (p.67), Pure Direct Mode (p.130), Enhancer (p.140), Hi-Res Mode (p.111), SURROUND:AI (p.66)
Sound	Tone Control (p.110), YPAO Volume (p.110), Adaptive DRC (p.110), Extra Bass (p.112)
Surround	Dialogue Lift (p.111), Dialogue Level (p.110), Subwoofer Trim (p.112)

Video	Video Mode (p.132), Video Adjustment (p.113)
Volume	Master Volume (p.63)
Lipsync	Lipsync (p.111), Delay (p.126)
Speaker Setup	Setting Pattern (p.121), Parametric EQ (p.124)
Zone Interlock	Power (p.103), Input (p.103), Volume (p.103) *1, 2

*1 The “Volume” setting is not available with Zone4.

*2 For “Volume”, the “Initial Volume” setting in the “Multi Zone” menu has priority.



To restore the default settings for the selected scene, select “Reset”.

Scene Rename

Changes the SCENE name displayed on the front display or on the TV.

Procedure

- 1 Use the cursor keys to select the SCENE name and press ENTER to enter the name edit screen.
- 2 Use the cursor keys and ENTER to rename.

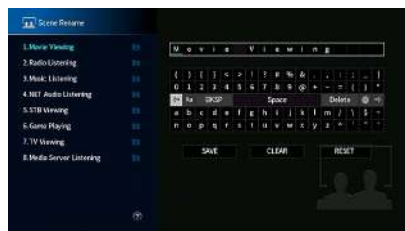

To clear the entry, select “CLEAR”.

- 3 Use the cursor keys to select “SAVE” and press ENTER.



To restore the default setting, select “RESET”.

- 4 To exit from the menu, Press SETUP.

Video/HDMI

Configures the video/HDMI settings.

Information

Displays information about the current video signal and the TVs connected to the HDMI OUT jacks.

Choices

HDMI Signal	Presence or absence of HDMI signal input/output
HDMI Resolution	Resolutions of input signal (analog or HDMI) and output signal (HDMI)
HDMI Monitor Video Resolution	Resolutions supported by the TV

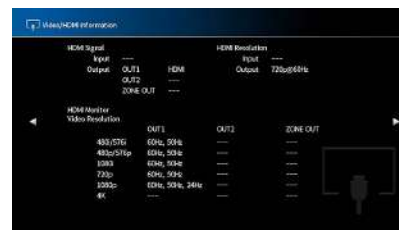

Video Mode

Configures the video signal processing settings.

Video Mode

Enables/disables the video signal processing (resolution, aspect ratio and video adjustments).

Settings

Direct	Disables the video signal processing.
Processing	Enables the video signal processing. Configure the settings in “Resolution”, “Aspect” and “Adjustment”.



When “Video Mode” is set to “Direct”, the unit transmits video signals with the least circuitry in order to reduce video output delay.

Resolution

Selects a resolution to output HDMI video signals when “Video Mode” is set to “Processing”.

Settings

Through	Does not convert the resolution.
Auto	Selects a resolution automatically in accordance with TV resolution.
480p/576p, 720p, 1080i, 1080p, 4K	Output video signals with a selected resolution. (Only the resolutions supported by your TV are selectable.)



If you need to select a resolution that is not supported by your TV, set “MONITOR CHECK” (p.149) in the “ADVANCED SETUP” menu to “SKIP” and try again. (Note that the output video may not be displayed on your TV normally.)

Aspect

Selects an aspect ratio to output HDMI video signals when “Video Mode” is set to “Processing”.

Settings

Through	Does not convert the aspect ratio.
16:9 Normal	Outputs 4:3 video signals to a 16:9 TV with black bands on either side of the screen.



This setting functions only when 480i/576i or 480p/576p signals are converted into 720p, 1080i, 1080p, or 2160p (4K) signals.

Adjustment

Configures the video adjustments when “Video Mode” is set to “Processing”. You can register the video adjustments as presets (up to 6).



The video adjustments work on the video signals with 1080p or lower resolution.

Setup procedure

- 1 Use the ENTER to select a preset number.
- 2 Use the cursor keys to select an item.



- 3 Use the cursor keys to select a setting.
- 4 To exit from the menu, press SETUP.

Detail Enhancement

Adjusts the enhancement effect of video details.

Setting range

0 to 50

Edge Enhancement

Adjusts the enhancement effect of video edges.

Setting range

0 to 50

Brightness

Adjusts the video brightness.

Setting range

-100 to 0 to +100

Contrast

Adjusts the video contrast.

Setting range

-100 to 0 to +100

Saturation

Adjusts the video saturation.

Setting range

-100 to 0 to +100

HDMI Control

Configures the HDMI control settings.

HDMI Control

Enables/disables HDMI Control (p.169).

Settings

<u>Off</u>	Disables HDMI Control.
On	Enables HDMI Control. Configure the settings in “TV Audio Input”, “ARC” and “Standby Sync”.



To use HDMI control, you need to perform the HDMI Control link setup (p.169) after connecting HDMI Control-compatible devices.

TV Audio Input

Selects an audio input jack of the unit to be used for TV audio input when “HDMI Control” is set to “On”. The unit’s input source automatically switches to TV audio when the TV input is switched to its built-in tuner.

Settings

AUDIO 1-3



When using ARC to input TV audio to the unit, you cannot use the input jacks selected here for connecting an external device because the input will be used for TV audio input.

ARC

Enables/disables ARC (p.171) when “HDMI Control” is set to “On”.

Settings

Off	Disables ARC.
<u>On</u>	Enables ARC.



You do not need to change this setting normally. In case noises are produced from the speakers connected to the unit because TV audio signals input to the unit via ARC are not supported by the unit, set “ARC” to “Off” and use the TV’s speakers.

Standby Sync

Select whether to use HDMI control to link the standby behavior of the TV and the unit when “HDMI Control” is set to “On”.

Settings

Off	Does not set the unit to standby mode when the TV is turned off.
On	Sets the unit to standby mode when the TV is turned off.
<u>Auto</u>	Sets the unit to standby mode when the TV is turned off only when the unit is receiving TV audio or HDMI signals.

HDMI Audio Output

Selects whether the HDMI sound is output from the TV speakers.



The “HDMI OUT1” setting is available only when “HDMI Control” is set to “Off”.

HDMI OUT1, HDMI OUT2, HDMI ZONE OUT

Enables/disables the audio output from a TV connected to the HDMI OUT 1 jack, HDMI OUT 2 jack or HDMI ZONE OUT.

Settings

<u>Off</u>	Disables the audio output from the TV.
On	Enables the audio output from the TV.



The HDMI OUT 1-2 jacks output 2-channel audio signals when the unit is turned on.

HDMI ZONE OUT Assign

Select the zone for which the HDMI OUT 3 (ZONE OUT) jack is used.

Settings

Zone2, Zone4



For details on audio signals that can be output to each zone, see “Multi-zone output” (p.169).

HDCP Version

Selects the HDCP version of the HDMI input jacks for watching 4K video content.

Input sources

AV 1-7

Settings

<u>Auto</u>	Automatically sets the version of HDCP according to content.
1.4	Sets the version of HDCP to always be 1.4.

HDMI Standby Through

Select whether to output videos/audio (input through HDMI jacks) to the TV when the unit is in stand by mode. If this function is set to “On” or “Auto”, you can use the input selection keys to select an HDMI input even when the unit is in standby mode (the standby indicator on the unit blinks).

Settings

<u>Off</u>	(This setting is available only when “HDMI Control” is set to “Off”.) Does not output videos/audio to the TV.
On	Outputs videos/audio to the TV. (The unit consumes more power than when “Off” is selected.)
Auto	Outputs videos/audio to the TV. If no signals are detected, the unit is set to the power saving mode.

Network

Configures the network settings.

Information

Displays the network information on the unit.

Choices

IP Address	IP address
Subnet Mask	Subnet mask
Default Gateway	The IP address of the default gateway
DNS Server (P)	The IP address of the primary DNS server
DNS Server (S)	The IP address of the secondary DNS server
MAC Address (Ethernet)	MAC address
MAC Address (Wi-Fi)	
Network Name	Network name (the unit's name on the network)
MusicCast Network	The status of the MusicCast network connection.
Wired/Wireless (Wi-Fi)	The status of the wired or wireless connection
SSID	(When using wireless [Wi-Fi] network connection) The SSID of the wireless network



Network Connection

Selects the network connection method.

Settings

<u>Wired</u>	Select this option when you want to connect the unit to a network with a commercially-available network cable (p.39).
Wireless (Wi-Fi)	Select this option when you want to connect the unit to a network via the wireless router (access point). For details on settings, see “Connecting the unit to a wireless network” (p.57).

IP Address

Configures the network parameters (such as IP address).

DHCP

Select whether to use a DHCP server.

Settings

Off	Does not use a DHCP server. Configure the network parameters manually. For details, see “Manual network settings”.
<u>On</u>	Uses a DHCP server to automatically obtain the unit’s network parameters (such as IP address).

IP Address

Set the network parameters (such as IP address, Subnet Mask, and Default Gateway) manually.

Manual network settings

- 1 Set “DHCP” to “Off”.
- 2 Use the cursor keys to select “IP Address” and press ENTER.

- 3 Use the cursor keys to select a parameter type and press ENTER.

IP Address	Specifies an IP address.
Subnet Mask	Specifies a subnet mask.
Default Gateway	Specifies the IP address of the default gateway.
DNS Server (P)	Specifies the IP address of the primary DNS server.
DNS Server (S)	Specifies the IP address of the secondary DNS server.

- 4 Use the cursor keys to move the edit position and to select a value.

- 5 To confirm the setting, press ENTER.

- 6 To configure another network parameter, repeat steps 2 to 4.

- 7 To exit from the menu, press SETUP.

Network Standby

Selects whether the unit can be turned on from other network devices (network standby).

Settings

Off	Disables the network standby function.
On	Enables the network standby function. (The unit consumes more power than when “Off” is selected.)
<u>Auto</u>	Enables the network standby function. (If “Network Connection” is set to “Wired”, the unit is set to the power saving mode when the network cable is disconnected.)



With an advanced energy saving design, this product achieves a low power consumption of not more than two watts when in Network Standby mode.

MAC Address Filter

Sets the MAC address filter to limit access to the unit from other network devices.

Filter

Enables/disables the MAC address filter.

Settings

<u>Off</u>	Disables the MAC address filter.
On	Enables the MAC address filter. In “MAC Address 1-10”, specify the MAC addresses of the network devices that will be permitted access to the unit.



AirPlay (p.97) and DMC (p.137) operations are not subject to the MAC address filter.

MAC Address 1-10

Specifies the MAC addresses (up to 10) of the network devices that will be permitted access to the unit when “Filter” is set to “On”.

Procedure

- 1 Use the cursor keys to select an MAC address number and press ENTER.
- 2 Use the cursor keys to move the edit position and to select a value.
- 3 To confirm the setting, press ENTER.
- 4 To exit from the menu, press SETUP.

DMC Control

Selects whether to allow a Digital Media Controller (DMC) to control playback. A Digital Media Controller (DMC) is a device that can control other network devices through the network. When this function is enabled, you can control playback of the unit from DMCs (such as Windows Media Player 12) on the same network.

Input source

SERVER

Settings

Disable	Does not allow DMCs to control playback.
<u>Enable</u>	Allows DMCs to control playback.

AirPlay Volume Interlock

Enables/disables volume control from iTunes/iPhone via AirPlay. When other than “Off” is set, you can adjust the unit’s volume from the iTunes/iPhone during playback.

Interlock

Settings

Off	Disables volume control from iTunes/iPhone
<u>Limited</u>	Enables volume control from iTunes/iPhone within the limited range (-80 dB to -20 dB and mute).
Full	Enables volume control from iTunes/iPhone in the full range (-80 dB to +16.5 dB and mute).

Network Name

Edits the network name (the unit's name on the network) displayed on other network devices.

Network Name

Setup procedure

- 1 Press ENTER to enter the name edit screen.
- 2 Use the cursor keys and ENTER to rename.

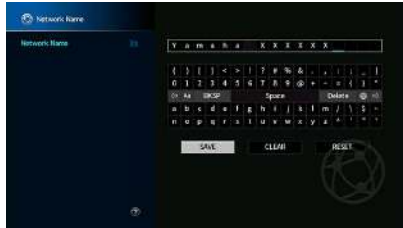

To clear the entry, select "CLEAR".

- 3 Use the cursor keys to select "SAVE" and press ENTER.



To restore the default setting, select "RESET".

- 4 To exit from the menu, press SETUP.

MusicCast Link Power Interlock

Selects whether turning on the power of the master device of the MusicCast network (the unit) also turns on the power of other devices of the network.

Settings

<u>Off</u>	Disables the power interlock from the unit (MusicCast master).
On	Enables the power interlock from the unit (MusicCast master).

Bluetooth

Configures the Bluetooth settings.

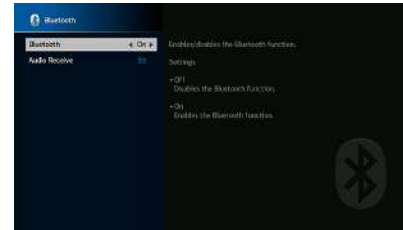

Bluetooth

Enables/disables the Bluetooth function (p.85).

Settings

<u>Off</u>	Disables the Bluetooth function.
On	Enables the Bluetooth function.

Audio Receive

Configures the Bluetooth settings when the unit is used as the Bluetooth audio receiver.

Disconnect

Terminates the Bluetooth connection between a Bluetooth device (such as a smartphone) and the unit.

Procedure

- 1 Select “Disconnect” and press ENTER to terminate the Bluetooth connection.



This setting is not available when no Bluetooth devices are connected.

Bluetooth Standby

Selects whether to enable/disable the function that turns on the unit from Bluetooth devices (Bluetooth standby). If this function is set to “On”, the unit automatically turns on when a connect operation is performed on the Bluetooth device.

Settings

Off	Disables the Bluetooth standby function.
On	Enables the Bluetooth standby function. (The unit consumes more power than when “Off” is selected.)



This setting is not available when “Network Standby” (p.136) is set to “Off”.

Multi Zone

Configures the multi zone settings.

Information

Displays information about Zone2, Zone3 and Zone4.

Choices

On/Off	Displays the status of each zone.
Input	The input source selected for Zone2, Zone3 and Zone4.
Volume	The volume setting for Zone2 and Zone3.
Tone Control	The tone control setting (the level of Treble and Bass) for Zone2 and Zone3.



Zone2, Zone3 Set

Configures the Zone2 or Zone3 settings.

Volume

Enables/disables volume adjustments for Zone2 or Zone3 output.

If you have connected an external amplifier with volume control to the unit, disable the volume adjustment for the corresponding zone.

Settings

Fixed	Disables volume adjustments for Zone2 or Zone3 output.
Variable	Enables volume adjustments for Zone2 or Zone3 output.

Max Volume

Sets the Zone2 or Zone3 limit value of the volumes.

Setting range

-60.0 dB to +15.0 dB (5.0 dB increments), +16.5 dB [20.5 to 90.5 (5.0 increments), 97.0]



This setting is available only when "Volume" is set to "Variable".

Initial Volume

Sets the Zone2 or Zone3 initial volume for when the unit is turned on.

Settings

<u>Off</u>	Sets the level at the volume level of the unit when it last entered standby mode.
On	Sets at Mute or the specified volume level (-80.0 dB to +16.5 dB, 0.5 dB increments) [0.5 to 97.0 (0.5 increments)]. (Specify a volume level which is lower than the "Max Volume" setting.)



This setting is available only when "Volume" is set to "Variable".

Audio Delay

Adjusts the audio output timing for Zone2 or Zone3 so that the audio is synchronized with the video.

Setting range

0 ms to 100 ms (1 ms increments)

Monaural

Switches between stereo and monaural for Zone2 or Zone3 output.

Settings

<u>Off</u>	Produces stereo sounds in Zone2 or Zone3.
On	Produces monaural sounds in Zone2 or Zone3.

Enhancer

Enables/disables Compressed Music Enhancer (p.71) for Zone2 or Zone3 output.

Settings

<u>Off</u>	Disables Compressed Music Enhancer.
On	Enables Compressed Music Enhancer.

Tone Control

Adjusts the level of high-frequency range (Treble) and low-frequency range (Bass) for Zone2 or Zone3 output.

Settings

<u>Auto</u>	Adjusts the levels of the high-frequency range (Treble) and low-frequency range (Bass) automatically in synchronization with the main volume, with correction for the auditory response of the human ear.
Manual	Adjusts the level of high-frequency range (Treble) and low-frequency range (Bass) manually (-6.0 to +6.0 dB, 0.5 dB increments).
Bypass	Does not adjust the level of high-frequency range (Treble) and low-frequency range (Bass).

Extra Bass

Enables/disables Extra Bass for Zone2 or Zone3 output. When Extra Bass is enabled, you can enjoy enhanced bass sounds, regardless of the size of speakers.

Settings

<u>Off</u>	Disables Extra Bass.
On	Enables Extra Bass.

Left / Right Balance

Adjusts the front speaker balance for Zone2 or Zone3 output.

Setting range

-20 to 0 to +20 (negative to the left and positive to the right)

Zone Rename

Changes the zone name displayed on the front display or TV screen.

Setup procedure

- 1 Use the cursor keys to select Zone, and then press ENTER.
- 2 Use the cursor keys and ENTER to rename.

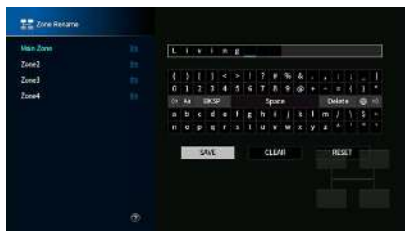

To clear the entry, select "CLEAR".

- 3 Use the cursor keys to select "SAVE" and press ENTER.



To restore the default setting, select "RESET".

- 4 To exit from the menu, press SETUP.

Party Mode Set

Enables/disables switching to the party mode (p.104) for each zone.

Choice

Target: Zone2, Target: Zone3, Target: Zone4

Settings

Disable	Disables switching to the party mode.
Enable	Enables switching to the party mode. You can turn on/off the party mode by pressing PARTY on the remote control.



When party mode is being used, the Disable/Enable setting cannot be changed.

System

Configures the system settings.

Information

Displays the system information on the unit.

Choices

Remote ID	The unit's remote control ID setting
TV Format	The unit's video signal type
Tuner Frequency Step	(Asia and General models only) The FM/AM tuning frequency setting of the unit
System ID	System ID number
Firmware Version	The version of firmware installed on the unit

Language

Select an on-screen menu language.

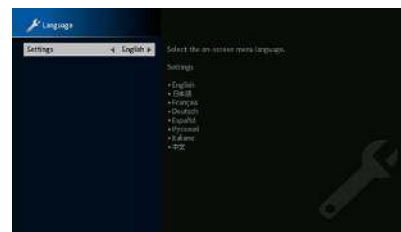

Settings

English, Japanese, French, German, Spanish, Russian, Italian, Chinese



The information on the front display is provided in English only.

Input Assignment

Assigns the COMPONENT VIDEO, COAXIAL and OPTICAL jacks to another input source.

Input Assignment

Procedure

Example: assigning the OPTICAL (②) jack to the input source “AV 2”

- 1 Use the cursor keys to select the cell at the intersection of “AV 2” and “OPTICAL”, and press ENTER.



- 2 Use the cursor keys to select “②” and press ENTER.

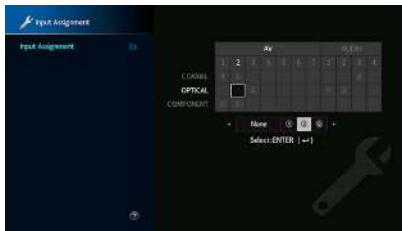

- 3 To exit from the menu, press SETUP.



You cannot assign both COAXIAL and OPTICAL jacks to the same input source.

Input Skip

Set which input sources are skipped when operating the INPUT key or AV CONTROLLER. You can select the desired input source quickly by using this function.



When using AV CONTROLLER, you cannot select the input sources set to “On” in this function.

Input sources

AV 1-7, AUX, AUDIO 1-4, PHONO, TUNER, (network sources), Bluetooth, USB, MULTI CH

Settings

Off	Does not skip the selected input source.
On	Skips the selected input source.

Input Rename (Auto)

Automatically changes the input source names displayed on the front display. You can select a name created by the Auto Rename function.

Input sources

AV 1-7, AUDIO 1-4

Procedure

- 1 Use the cursor keys to select an input source to be renamed.
- 2 Use the cursor keys to select “Auto”.
- 3 To change another input source name, repeat steps 1 to 2.
- 4 Press SETUP.



- When “Auto” is selected, the created name is saved even after the external device is disconnected. To reset to the default setting, switch the setting to “Manual” and then back to “Auto”.
- “Auto” can be selected for AUDIO 1-4 only if a digital “Input Assignment” setting is selected.

Input Rename (Manual)

Allows the input source names displayed on the front display to be set manually.

Input sources

AV 1-7, AUX, AUDIO 1-4, PHONO, TUNER, MusicCast Link, SERVER, NET RADIO, Bluetooth, USB, MULTI CH

Procedure

- 1 Use the cursor keys to select an input source to be renamed.
- 2 Press ENTER.
The cursor moves to the name edit screen.
- 3 Use the cursor keys and ENTER key to edit the name, and then select “SAVE” and press ENTER.



- To cancel the entry, select “CLEAR”.
- If you select “RESET”, the default input name will be inserted into the editing area.

- 4 To change another input source name, repeat steps 1 to 3.

- 5 Press SETUP.

Auto Play

Enables/disables Auto Play function in Internet streaming services and following input sources.

Input sources

(network sources), SERVER, NET RADIO, Bluetooth, USB

Settings

Off	Disables Auto Play function.
<u>On</u>	Starts automatically to play back the last content which you played back.
Auto	Starts automatically to play back the content which only you played back at setting the unit to standby mode.



In some input sources or content, you might not enable Auto Play function.



With some input sources, “Auto” cannot be selected.

DSP Skip

Set which sound programs are skipped when operating the PROGRAM key. You can select the desired sound program quickly by using this function.

Settings

<u>Off</u>	Does not skip the selected sound program.
On	Skips the selected sound program.

Remote Key

Configures the Remote Key settings.

PROGRAM Key

Sets the function that is assigned to the PROGRAM key on the remote control. You can use the PROGRAM key for other than DSP program selection.

Settings

<u>Assign 1</u>	Enables selecting the DSP Programs.
Assign 2	Enables selecting just the DSP Movie/Music Programs. The up key of the PROGRAM keys: toggle between the Movie Programs. The down key of the PROGRAM keys: toggle between the Music Programs
Assign 3	Enables selecting the NETWORK sources.
Assign 4	Enables moving to the previous/next page of the Browse Screen.
Assign 5	Enables fine-adjusting the subwoofer volume.
Assign 6	Enables adjusting the volume of dialogue sounds.
Assign 7	Enables selecting shuffle/repeat settings. The up key of the PROGRAM keys: repeat The down key of the PROGRAM keys: shuffle
Assign 8	Displays the front/on-screen display information. The up key of the PROGRAM keys: front display information The down key of the PROGRAM keys: on-screen display information



This setting does not change the function of the PROGRAM key on the front panel.

Color Key

Set the function to operate the external device with the RED / GREEN / YELLOW / BLUE key on the remote control.

Settings

<u>Default</u>	Assigns the functions of devices connected to the unit with an HDMI cable. This setting is effective when “HDMI Control” is set to “On”.
TV Control	Assigns the functions of TV Control to each key. RED: EXIT (closes the menu on the TV) GREEN: INFO (displays information about the TV such as the resolution) YELLOW: BROADCAST (switches the TV broadcast type) BLUE: INPUT (switches the TV input) This setting is effective when “HDMI Control” is set to “On”.



- For details on “HDMI Control” in the “Setup” menu, see “HDMI Control” (p.134)
- To use HDMI control, you need to perform the HDMI Control link setup after connecting HDMI Control compatible devices (p.169).
- HDMI Control might not work properly.

Display Set

Configures the settings related to the front display and TV screen display.

Dimmer (Front Display)

Adjusts the brightness of the front display.

Setting range

-4 to 0 (higher to brighten)

Volume

Switches the scale of the volume display.

Settings

<u>dB</u>	Displays the volume in the “dB” unit.
0-97	Displays the volume in the numeric value (0 to 97).

Short Message

Selects whether to display short messages on the TV screen when the unit is operated (such as input selection and volume adjustment).

Settings

<u>On</u>	Displays short messages on the TV screen.
Off	Does not display short messages on the TV screen.

Wallpaper

Selects the image to be used as wallpaper on the TV.

Settings

<u>Piano</u>	Displays the piano image on the TV screen when there is no video signal.
Gray	Displays a gray background on the TV screen when there is no video signal.

Trigger Output1, Trigger Output2

Sets the TRIGGER OUT 1-2 jacks to function in sync with the power status of each zone or input switching.

Trigger Mode

Specifies the condition for the TRIGGER OUT jack to function.

Settings

<u>Power</u>	The TRIGGER OUT jack functions in sync with the power status of the zone specified with "Target Zone".
Source	The TRIGGER OUT jack functions in sync with the input switching in the zone specified with "Target Zone". An electronic signal is transmitted according to the setting made in "Source."
Manual	Select this to manually switch the output level for electronic signal transmission with "Manual".

Source

Specifies the output level of the electronic signal transmitted with each input, switching when "Trigger Mode" is set to "Source".

Choices

AV 1-7, AUX, AUDIO 1-4, PHONO, TUNER, (network sources), Bluetooth, USB, MULTI CH

Settings

Low	Stops the electronic signal transmission when you switch to the input source specified in this option.
<u>High</u>	Transmits the electronic signal when you switch to the input source specified in this option.

Manual

Switches the output level for electronic signal transmission manually when "Trigger Mode" is set to "Manual". This setting can also be used to confirm proper function of the external device connected via the TRIGGER OUT jack.

Choices

Low	Stops the electronic signal transmission.
<u>High</u>	Transmits the electronic signal.

Target Zone

Specifies the zone with which the TRIGGER OUT jack functions are synchronized.

Settings

Main	When "Trigger Mode" is set to "Power", electronic signal transmission is synchronized with the power status of the main zone. When "Trigger Mode" is set to "Source", electronic signal transmission is synchronized with the input switching in the main zone.
Zone2	When "Trigger Mode" is set to "Power", electronic signal transmission is synchronized with the power status of Zone2. When "Trigger Mode" is set to "Source", electronic signal transmission is synchronized with the input switching in Zone2.
Zone3	When "Trigger Mode" is set to "Power", electronic signal transmission is synchronized with power status of Zone3. When "Trigger Mode" is set to "Source", electronic signal transmission is synchronized with input switching in Zone3.
Zone4	When "Trigger Mode" is set to "Power", electronic signal transmission is synchronized with power status of Zone4. When "Trigger Mode" is set to "Source", electronic signal transmission is synchronized with input switching in Zone4.
<u>All</u>	When "Trigger Mode" is set to "Power", electronic signal transmission is synchronized with the power status of any zone. When "Trigger Mode" is set to "Source", electronic signal transmission is synchronized with the input switching in any zone.

ECO

Changes the setting for the auto-standby function.

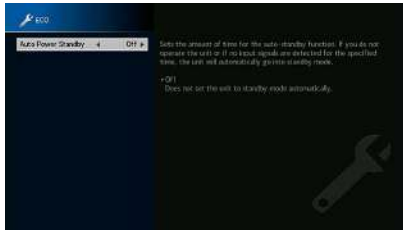

Auto Power Standby

Sets the amount of time for the auto-standby function. If you do not operate the unit or if no input signals are detected for the specified time, the unit will automatically go into standby mode.

Settings

Off	Does not set the unit to standby mode automatically.
5 minutes, 20 minutes	Sets the unit to standby mode when you have not operated the unit and the unit has not detected any input signal for the specified time.
2 hours, 4 hours, 8 hours, 12 hours	Sets the unit to standby mode when you have not operated the unit for the specified time.

Default

U.K., Europe and Russia models: 20 minutes

Other models: Off



Just before the unit enters standby mode, “AutoPowerStdby” appears and then countdown starts in the front display.

Memory Guard

Prevents accidental changes to the settings.

Memory Guard

Settings

Off	Does not protect the settings.
On	Protects the settings until “Off” is selected.



When “Memory Guard” is set to “On”, the lock icon (🔒) is displayed on the menu screen.

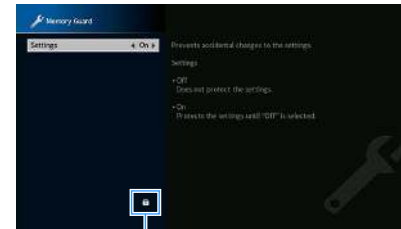

Icon

Firmware Update

Update the firmware.

Firmware Update

Updates the firmware via the network. You can also check the firmware version and system ID.

Item

Firmware Version	The version of the firmware installed on the unit.
System ID	The system ID number.



- Firmware update takes about 20 minutes or more (depending on your Internet connection speed).
- If the Internet connection speed is slow, or the unit is connected to the wireless network, network update may not be possible depending on the condition of the wireless connection. In this case, wait a while before updating the firmware again, or update the firmware using the USB memory device. For details on using the USB memory device, see “Updating the firmware (FIRM. UPDATE)” (p.151).

USB Update

Perform a firmware update using a USB memory device from the “ADVANCED SETUP” menu.





For information about updating the firmware using a USB memory device, see “Updating the firmware (FIRM. UPDATE)” (p.151) in “Configuring the system settings (ADVANCED SETUP menu)”.

Configuring the system settings (ADVANCED SETUP menu)

Configure the system settings of the unit while viewing the front display.

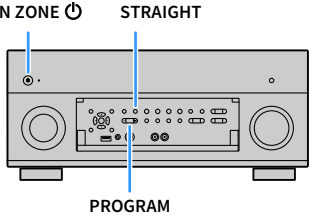
Perform the following basic procedure to operate the “ADVANCED SETUP” menu.

- 1 Set the unit to standby mode.
 - 2 While holding down STRAIGHT on the front panel, press MAIN ZONE .
- 
- MAIN ZONE  STRAIGHT
- PROGRAM
- 3 Press PROGRAM to select an item.
 - 4 Press STRAIGHT to select a setting.
 - 5 Press MAIN ZONE  to set the unit to standby mode and turn it on again.

The new settings take effect.

ADVANCED SETUP menu items



Default settings are underlined.

Item	Function	Page
REMOTE SENSOR	Turns on/off of the remote control sensor on the main unit.	148
REMOTE ID	Selects the unit's remote control ID.	148
TUNER FRQ STEP	(Brazil, Asia and General models only) Changes the FM/AM tuning frequency setting.	148
TV FORMAT	Switches the video signal type.	149
MONITOR CHECK	Removes the limitation on HDMI video output.	149
4K MODE	Selects the HDMI 4K (60 Hz/50 Hz) signal format.	149
DTS MODE	Switches the DTS format notification setting.	150
BACKUP/RESTORE	Creates backup of the settings of the unit, or recovers the settings from the backup.	150
INITIALIZE	Restores the default settings.	150
FIRM. UPDATE	Updates the firmware.	151
VERSION	Checks the version of firmware currently installed on the unit.	151

Turning on/off the remote control sensor (REMOTE SENSOR)



Turn on/off the remote control sensor on the main unit. While the remote control sensor is turned off, you cannot control the unit from the remote control.

Settings

<u>ON</u>	Turns on the remote control sensor.
OFF	Turns off the remote control sensor.

Selecting the remote control ID (REMOTE ID)



Change the unit's remote control ID so that it matches the remote control's ID (default: ID1). When using multiple Yamaha AV receivers, you can set each remote control with a unique remote control ID for its corresponding receiver.

Settings

ID1, ID2

■ Changing the remote control ID of the remote control

- 1 To select ID1, hold down the cursor key (◀) and SCENE1 together for 5 seconds.
To select ID2, hold down the cursor key (◀) and SCENE2 together for 5 seconds.



If the remote control ID does not match that of the unit, "RemID Mismatch" appears on the unit's front display when the remote control is operated.

Changing the FM/AM tuning frequency setting (TUNER FRQ STEP)

(Brazil, Asia and General models only)



Change the FM/AM tuning frequency setting of the unit depending on your country or region.

Settings

<u>FM100/AM10</u>	Select this when you want to adjust the FM frequency by 100-kHz steps and AM by 10-kHz steps.
<u>FM50/AM9</u>	Select this when you want to adjust the FM frequency by 50-kHz steps and AM by 9-kHz steps.

Switching the video signal type (TV FORMAT)



Switch the video signal type of the unit so that it matches to the format of your TV.

Settings

NTSC, PAL

Default

U.S.A., Canada, Korea, Brazil and General models: NTSC

Other models: PAL

Removing the limitation on HDMI video output (MONITOR CHECK)



The unit automatically detects resolutions supported by a TV connected to the HDMI OUT jack.

Disable the monitor check function if you want to specify a resolution in “Resolution” (p.133) when the unit cannot detect the TV’s resolution or when you want to specify a different resolution than the detected resolution.

Settings

<u>YES</u>	Enables the monitor check function. (Outputs video signals with a resolution supported by the TV only.)
SKIP	Disables the monitor check function. (Outputs video signals with a specified resolution regardless of compatibility with the TV.)



Reset to “YES” if the unit becomes inoperable because video from the unit cannot be displayed on the TV after “MONITOR CHECK” has been set to “SKIP”.

Selecting the HDMI 4K signal format (4K MODE)



Selects the format of signals input/output at the unit when HDMI 4K compatible TV and playback device are connected to the unit.

Settings

	Inputs/outputs 4K signals shown in the table below.
<u>MODE 1</u>	Depending on the connected device or HDMI cables, video may not be displayed correctly. In this case, select “MODE 2”.
MODE 2	Inputs/outputs 4K signals shown in the table below.

Format

		MODE 1			MODE 2		
		8 bit	10 bit	12 bit	8 bit	10 bit	12 bit
4K/60, 50 Hz	RGB 4:4:4	✓	—	—	—		
	YCbCr 4:4:4	✓	—	—	—		
	YCbCr 4:2:2	✓			—		
	YCbCr 4:2:0	✓			✓	—	
4K/30, 25, 24 Hz	RGB 4:4:4	✓			✓	—	
	YCbCr 4:4:4	✓			✓	—	
	YCbCr 4:2:2	✓			✓		



When “MODE 1” is selected, use a Premium High Speed HDMI Cable or Premium High Speed Cable with Ethernet.

Switching the DTS format notification setting (DTS MODE)



Switches the DTS format notification setting.

This setting informs the video device (such as BD/DVD player) about the DTS formats that the unit supports.

Settings

MODE 1	This mode conforms to the DTS:X standard. Use this setting under normal circumstances.
MODE 2	Use this setting if the video device (such as BD/DVD player) fails to properly output a DTS signal even when it is playing back DTS-HD or DTS:X content.

Backing up/recovering the settings (BACKUP/RESTORE)



Backups and restores all the unit's setting to a USB memory device. Prepare a USB memory device using FAT16 or FAT32 format in advance.

Choices

BACKUP	Creates backup of the settings of the unit in the USB memory device.
RESTORE	Restores the settings of the unit from the backup (available only when backup has been created).

Backup/rstore procedure

- 1 Connect the USB memory device to the USB jack on the front panel.
- 2 To start the process, press STRAIGHT to select “BACKUP” or “RESTORE” and then press INFO on the front panel.
- 3 Press INFO again after the confirmation message appears on the front display.



To cancel the operation, press STRAIGHT.

- 4 When “Please Power Off!” appears on the front display, press (power) to set the unit to standby mode and turn it on again.

If “Failed” appears on the front display, check the following and start the process again.

In case of “BACKUP”:

- You cannot overwrite save. When you save the settings repeatedly, please move the file in different folder.
- The file is stored by the name of “MC_backup_(model name).dat” in the root of the USB memory device.

In case of “RESTORE”:

- Check that the file is stored in the route of the USB memory device.



- “RESTORE” is effective after backing up all the settings.
- Do not turn off the unit during the backuping and restoring process. Otherwise, the settings may not be restored correctly.
- The user information (such as account, password) is not saved.

Restoring the default settings (INITIALIZE)



Restores the default settings for the unit.

Choices

VIDEO	Restores the default settings for video configurations.
ALL	Restores the default settings for the unit.
CANCEL	Does not perform an initialization.

Updating the firmware (FIRM. UPDATE)



New firmware that provides additional features or product improvements will be released as needed. Updates can be downloaded from the Yamaha website. If the unit is connected to the Internet, you can download the firmware via the network. For details, refer to the information supplied with updates.

Firmware update procedure

Do not perform this procedure unless firmware update is necessary. Also, make sure you read the information supplied with updates before updating the firmware.

- 1 Press STRAIGHT repeatedly to select “USB” or “NETWORK” and press INFO to start firmware update.

Choices

USB	Update the firmware using a USB memory device.
NETWORK	Update the firmware via the network.



If the unit detects newer firmware over the network, the corresponding message will be displayed after SETUP is pressed. In this case, you can also update the unit's firmware by following the procedure in “Updating the unit's firmware via the network” (p.152).

Checking the firmware version (VERSION)



Check the version of firmware currently installed on the unit.



- You can also check the firmware version in “Information” (p.132) in the “System” menu.
- It may take a while until the firmware version is displayed.

Updating the unit's firmware via the network

New firmware that provides additional features or product improvements will be released as needed. If the unit is connected to the Internet, you can download the firmware via the network and update it.

Note

- Do not operate the unit or disconnect the power cable or network cable during firmware update. Firmware update takes about 20 minutes or more (depending on your Internet connection speed).
- If the unit is connected to the wireless network, network update may not be possible depending on the condition of the wireless connection. In this case, update the firmware using the USB memory device (p.151).
- For details on update, visit the Yamaha website.



- The firmware update indicator (p.15) on the front display lights up when a firmware update is available via the network.
- You can also update the firmware using the USB memory device from the “ADVANCED SETUP” menu (p.151).
- You can also start the firmware update by pressing INFO on the front panel.

A firmware update is available if the following message is displayed after SETUP is pressed.



Updating the unit's firmware

- 1 Read the on-screen description.
- 2 Use the cursor keys to select “START” and press ENTER. The on-screen display turns off and the firmware update begins.
- 3 If “UPDATE SUCCESS PLEASE POWER OFF!” appears on the front display, press MAIN ZONE on the front panel.

The firmware update is complete.



- If you want to cancel without doing anything now, select “CLOSE”.
- Firmware update takes about 20 minutes or more.
- You might not get the message or the lighting up firmware update indicator on the front display depending on the condition of the network connection. In this case, update the firmware using the USB memory device (p.151).
- For details on update, visit the Yamaha website.
- To perform the update when turning off the unit, select “LATER” in step 2, and then follow the on-screen instructions. When a screen to confirm the firmware update appears after turning off the unit, press ENTER to start the firmware update. When the firmware update is complete, the unit enters standby mode automatically.
- To perform the update when turning off the unit, refer to the following instructions.
 - The firmware update can be started by pressing INFO on the front panel.
 - The unit turns off automatically without performing the firmware update if two minutes pass after the screen to confirm the firmware update is displayed.
 - To cancel the firmware update process, press RETURN, and the unit will turn off.
 - The unit turns off without performing the firmware update if you turn off the unit with AV CONTROLLER or MusicCast CONTROLLER.

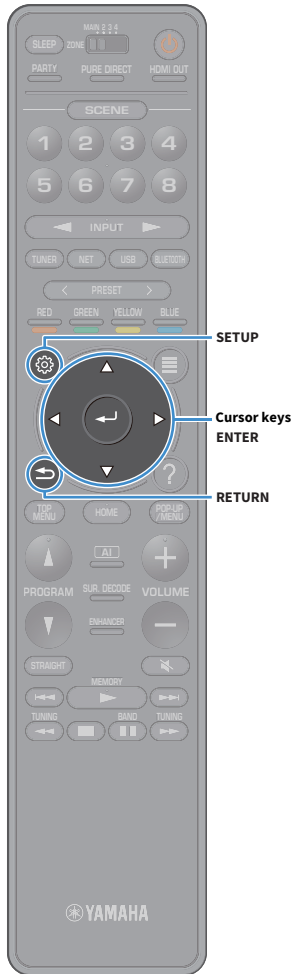

APPENDIX

Frequently asked questions

The new speaker system does not provide an ideal sound balance...

If you have changed speakers or have a new speaker system, use “YPAO” to optimize the speaker settings again (p.44). If you want to adjust the speaker settings manually, use “Speaker” in the “Setup” menu (p.121).

Since we have small children, we want to set limitations on the volume control...

If a small child accidentally operates the controls on the main unit or remote control, the volume may suddenly increase. This may also cause injury or damage the power amplifier or speakers. We recommend using “Max Volume” in the “Setup” menu to set the maximum volume level for the unit in advance (p.130). You can also set the maximum volume for Zone2 or Zone3 (p.140).

I am occasionally startled by a sudden loud sound when turning on the unit...

By default, the volume level when the unit last entered standby mode is automatically applied. If you want to fix the volume, use “Initial Volume” in the “Setup” menu to set the volume to be applied when the receiver is turned on (p.130). You can also set the initial volume for Zone2 or Zone3 (p.140).

We are bothered by volume differences when switching between input sources...

You can correct volume differences between input sources by utilizing “Input Trim” in the “Option” menu (p.112).

I made HDMI connections but HDMI Control does not work at all...

To use HDMI Control, you need to perform the HDMI Control link setup (p.169). After connecting HDMI Control-compatible devices (such as BD/DVD players) to the unit, enable HDMI Control on each device and perform the HDMI Control link setup. This setup is required

every time you add a new HDMI Control-compatible device to your system. For information on how HDMI Control works between your TV and playback devices, refer to the instruction manuals for each device.

I want to turn off the on-screen messages displayed during operations...

By default, short messages are displayed on the TV screen when the unit is operated (such as input selection and volume adjustment). If the short messages bother you when you are watching movies or sports, configure “Short Message” (p.144) in the “Setup” menu to turn off the short messages.

I want to prevent accidental changes to the settings...

You can protect the settings configured on the unit (such as speaker settings) by utilizing “Memory Guard” in the “Setup” menu (p.146).

The unit’s remote control is simultaneously controlling another Yamaha product as well as the unit...

When using multiple Yamaha products, the remote control may work on another Yamaha product or another remote control may work on the unit. If this happens, register different remote control IDs for the devices that you want to control with each remote control (p.148).

I want to enjoy videos/audio played back on the video device even when the unit is in standby mode...

If you have connected a video device to the unit with HDMI, you can output videos/audio played back on the video device to the TV even when the unit is in standby mode. To use this function, set “HDMI Standby Through” (p.135) in the “Setup” menu to “On” or “Auto”. You can also switch the input source using the remote control of the unit when this function is enabled.

Troubleshooting

Refer to the table below when the unit does not function properly.

If the problem you are experiencing is not listed below or if the instructions below do not help, turn off the unit and power amplifier, disconnect the power cable, and contact the nearest authorized Yamaha dealer or service center.

First, check the following:

- 1** The power cables of the unit, power amplifier, TV and playback devices (such as BD/DVD players) are connected to AC wall outlets securely.
- 2** The unit, power amplifier, subwoofer, TV and playback devices (such as BD/DVD players) are turned on.
- 3** The connectors of each cable are securely inserted in to jacks on each device.

Power, system and remote control

Problem	Cause	Remedy
The power does not turn on.	The protection circuitry has been activated three times consecutively. When the unit is in this condition, the standby indicator on the unit blinks if you try to turn on the power.	As a safety precaution, capability to turn on the power is disabled. Contact your nearest Yamaha dealer or service center to request repair.
The power does not turn off.	The internal microcomputer has frozen, due to an external electric shock (such as lightning or excessive static electricity) or to a drop in the power supply voltage.	Hold down on the front panel for more than 10 seconds to initialize and reboot the unit. (If the problem persists, disconnect the power cable from the AC wall outlet and plug it again.)
The unit enters standby mode automatically.	The sleep timer worked.	Turn on the unit and start playback again.
	The auto-standby function activated because the unit was not used for the specified time.	To disable the auto-standby function, set "Auto Power Standby" in the "Setup" menu to "Off" (p.146).
The unit is not reacting.	The internal microcomputer is frozen, due to an external electric shock (such as lightning or excessive static electricity) or to a drop in the power supply voltage.	Hold down MAIN ZONE  on the front panel for more than 10 seconds to initialize and reboot the unit. (If the problem persists, disconnect the power cable from the AC wall outlet and plug it again.)
The unit cannot be controlled using the remote control.	The unit is out of the operating range.	Use the remote control within the operating range (p.6).
	The batteries are weak.	Replace with new batteries.
	The unit's remote control sensor is exposed to direct sunlight or strong lighting.	Adjust the lighting angle, or reposition the unit.
	The remote control IDs of the unit and the remote control are not identical.	Change the remote control ID of the unit or the remote control (p.148).
	The remote control sensor on the main unit is turned off.	Set "REMOTE SENSOR" in the "ADVANCED SETUP" menu to "ON" (p.148).

Problem	Cause	Remedy
The RED/GREEN/YELLOW/BLUE keys of the remote control do not operate	The device which is connected to the unit via HDMI does not support the operation of the RED/GREEN/YELLOW/BLUE keys.	Use a device which supports the operation of the RED/GREEN/YELLOW/BLUE keys.
	The settings of the RED/GREEN/YELLOW/BLUE keys of the unit's remote control have been changed.	Set "Color Key" (p.144) in the "Setup" menu to "Default".
	HDMI control setting is "Off".	Set "HDMI Control" (p.134) in the "Setup" menu to "On".

Audio

Problem	Cause	Remedy
No sound.	Another input source is selected.	Select an appropriate input source with the input selection keys.
	Signals that the unit cannot reproduce are being input.	Some digital audio formats cannot be played back on the unit. To check the audio format of the input signal, use "Information" in the "Sound" menu (p.125).
	The cable connecting the unit and playback device is defective.	If there is no problem with the connection, replace with another cable.
	A device connected to the output jacks of the unit is not turned on.	Turn on all devices connected to the output jacks of the unit.
The volume cannot be increased.	The maximum volume is set.	Use "Max Volume" in the "Setup" menu to adjust the maximum volume (p.130).
No sound is coming from a specific speaker.	The playback source does not contain a signal for the channel.	To check it, use "Information" in the "Sound" menu (p.125).
	The currently selected sound program/decoder does not use the speaker.	To check it, use "Test Tone" in the "Setup" menu (p.125).
	Audio output of the speaker is disabled.	Perform "YPAO" (p.44) or use "Configuration" in the "Setup" menu to change the speaker settings (p.121).
	The volume of the speaker is set too low.	Perform "YPAO" (p.44) or use "Level" in the "Setup" menu to adjust the speaker volume (p.123).
	The speaker cable connecting the power amplifier and the speaker is defective.	If there is no problem with the connection, replace with another speaker cable.
	The speaker is malfunctioning.	To check it, replace with another speaker. If the problem persists, the power amplifier may be malfunctioning.
No sound is coming from the subwoofer.	The playback source does not contain LFE or low-frequency signals.	To check if the subwoofer is working properly, use "Test Tone" in the "Setup" menu (p.125).
	Subwoofer output is disabled.	Perform "YPAO" (p.44) or set "Subwoofer 1" or "Subwoofer 2" in the "Setup" menu to "Use" (p.123).
	The volume of the subwoofer is too low.	Adjust the volume on the subwoofer.
	The subwoofer has been turned off by its auto-standby function.	Disable the auto-standby function of the subwoofer or adjust its sensitivity level.
No sound from the playback device (connected to the unit with HDMI).	The TV does not support HDCP (High-bandwidth Digital Content Protection).	Refer to the instruction manuals for the TV and check the TV's specifications.
	The number of devices connected to the HDMI OUT jack exceeds the limit.	Disconnect some of the HDMI devices.

Problem	Cause	Remedy
No sound from the playback device (when HDMI Control is used).	The TV is set to output audio from the TV speakers.	Change the audio output setting on your TV so that the playback device audio is output from the speakers connected to the power amplifier.
	TV audio is selected as the input source.	Select an appropriate input source with the input selection keys.
No sound from the TV (when HDMI Control is used).	The TV is set to output audio from the TV speakers.	Change the audio output setting on your TV so that the TV audio is output from the speakers connected to the power amplifier.
	A TV that does not support ARC is connected to the unit only with an HDMI cable.	Use a digital optical cable to make an audio connection (p.33).
	(If the TV is connected to the unit with an audio cable) The TV audio input setting does not match the actual connection.	Use "TV Audio Input" in the "Setup" menu to select the correct audio input jack (p.134).
	(If you are trying to use ARC) ARC is disabled on the unit or TV.	Set "ARC" in the "Setup" menu to "On" (p.134). Also, enable ARC on the TV.
No sound is coming from the Zone assigned with "HDMI ZONE OUT Assign".	The audio output from the HDMI OUT 3 (ZONE OUT) jack is disabled.	Set "HDMI Audio Output - HDMI ZONE OUT" in the "Setup" menu to "On" (p.134).
Only the front speakers work on multichannel audio.	The playback device is set to output 2-channel audio (such as PCM) only.	To check it, use "Information" in the "Sound" menu (p.125). If necessary, change the digital audio output setting on the playback device.
Noise/hum is heard.	The unit is too close to another digital or radio frequency device.	Move the unit further away from the device.
	The cable connecting the unit and playback device is defective.	If there is no problem with the connection, replace with another cable.
The sound is distorted.	The volume of the unit is too high.	Turn down the volume.
The sound is interrupted.	HDMI audio output may be interrupted during some zone operations due to internal circuitry switching.	For details, see "Connecting an HDMI-compatible device to play back videos/audio" (p.101).

Video

Problem	Cause	Remedy
No video.	Another input source is selected on the unit.	Select an appropriate input source with the input selection keys.
	Another input source is selected on the TV.	Switch the TV input to display the video from the unit.
	The video signal output from the unit is not supported by the TV.	Set "MONITOR CHECK" in the "ADVANCED SETUP" menu to "YES" (p.149).
	The cable connecting the unit and TV (or playback device) is defective.	If there is no problem with the connection, replace with another cable.
No video from the playback device (connected to the unit with HDMI).	The input video signal (resolution) is not supported by the unit.	To check the information about the current video signal (resolution), use "Video/HDMI" in the "Setup" menu (p.132). For information about video signals supported by the unit, see "HDMI signal compatibility" (p.171).
	The TV does not support HDCP (High-bandwidth Digital Content Protection).	Refer to the instruction manuals for the TV and check the TV's specifications. If you want to play back contents that require HDCP 2.2-compatible devices, both the TV and playback device must support HDCP 2.2.
	The number of devices connected to the HDMI OUT jack is over the limit.	Disconnect some of the HDMI devices.
The menu of the unit is not displayed on the TV.	Another input source is selected on the TV.	Switch the TV input to display the video from the unit (HDMI OUT jack).
The video is interrupted.	(If you are using 2 TVs in the main zone) Another TV is turned off when "HDMI OUT 1+2" is selected.	Select "HDMI OUT 1" or "HDMI OUT 2" to output the signals only to the TV you are using (p.63).
	HDMI audio output may be interrupted during some zone operations due to internal circuitry switching.	For details, see "Connecting an HDMI-compatible device to play back videos/audio" (p.101).

FM/AM radio (AM radio feature is not available for the Australia, U.K., Europe, Middle East and Russia models)

Problem	Cause	Remedy
FM radio reception is weak or noisy.	There is multi-path interference.	Adjust the FM antenna height or orientation, or place it in a different location.
	Your area is too far from the FM station transmitter.	Set "FM Mode" in the "Option" menu to "Monaural" to select monaural FM radio reception (p.113). Use an outdoor FM antenna. We recommend using a sensitive multi-element antenna.
AM radio reception is weak or noisy.	The noises may be caused by fluorescent lamps, motors, thermostats, or other electrical equipment.	It is difficult to completely eliminate noise. It may be reduced by using an outdoor AM antenna.
Radio stations cannot be selected automatically.	Your area is too far from the FM station transmitter.	Select the station manually (p.73).
		Use an outdoor antenna. We recommend using a sensitive multi-element antenna.
	The AM radio signal is weak.	Adjust the AM antenna orientation.
		Select the station manually (p.73). Use an outdoor AM antenna. Connect it to the ANTENNA (AM) jack together with the supplied AM antenna.

DAB radio (Australia, U.K., Europe, Middle East and Russia models only)

Problem	Cause	Remedy
No DAB radio reception.	An initial scan has not been performed.	Perform an initial scan to receive DAB radio (p.76).
No DAB radio reception even after performing an initial scan.	Reception strength of DAB radio is poor.	Check reception strength in "Tune AID" in the "Option" menu (p.79), and adjust the antenna height or orientation, or place it in a different location.
	There is no DAB coverage in your area.	Check with your dealer or WorldDAB online at " http://www.worlddab.org " for a listing of the DAB coverage in your area.
DAB radio reception is weak or noisy.	There is multi-path interference.	Check reception strength in "Tune AID" in the "Option" menu (p.79), and adjust the antenna height or orientation, or place it in a different location.
	Your area is too far from the DAB station transmitter.	Use an outdoor antenna. We recommend using a sensitive multi-element antenna.
DAB information is not available or is inaccurate.	The selected DAB radio station may be temporarily out of service or may not provide information.	Contact the DAB broadcaster.
No DAB radio sound.	The selected DAB radio station may be temporarily out of service.	Try the station later or select another station.

Bluetooth

Problem	Cause	Remedy
A Bluetooth connection cannot be established.	The Bluetooth function of the unit is disabled.	Enable the Bluetooth function (p.138).
	Another Bluetooth device is already connected to the unit.	Terminate the current Bluetooth connection and then establish a new connection (p.85).
	The unit and the Bluetooth device are too far apart.	Move the Bluetooth device closer to the unit.
	There is a device (such as microwave oven and wireless LAN) that outputs signals in the 2.4 GHz frequency band nearby.	Move the unit away from those devices.
	The Bluetooth device does not support A2DP.	Use a Bluetooth device that supports A2DP.
	The connection information registered on the Bluetooth device is not working for some reason.	Delete the connection information on the Bluetooth device, and then establish a connection between the Bluetooth device and the unit again (p.85).
No sound is produced, or the sound is interrupted during playback.	The volume of the Bluetooth device is set too low.	Turn up the volume of the Bluetooth device.
	The Bluetooth device is not set to send audio signals to the unit.	Switch the audio output of the Bluetooth device to the unit.
	The Bluetooth connection has been terminated.	Establish a Bluetooth connection between the Bluetooth device and the unit again (p.85).
	The unit and the Bluetooth device are too far apart.	Move the Bluetooth device closer to the unit.
	There is a device (such as microwave oven and wireless LAN) that outputs signals in the 2.4 GHz frequency band nearby.	Move the unit away from those devices.

USB and network

Problem	Cause	Remedy
The unit does not detect the USB device.	The USB device is not connected to the USB jack securely.	Turn off the unit, reconnect your USB device, and turn the unit on again.
	The file system of the USB device is not FAT16 or FAT32.	Use a USB device with FAT16 or FAT32 format.
Folders and files in the USB device cannot be viewed.	The data in the USB device is protected by the encryption.	Use a USB device without an encryption function.
The files in the USB device cannot be played back continuously.	Files not supported by the unit exist in the selected folder.	If the unit detects a series of unsupported files (such as images and hidden files) during playback, playback stops automatically. Do not store the unsupported files in the playback folder.
The network feature does not function.	The network parameters (IP address) have not been obtained properly.	Enable the DHCP server function on your router and set “DHCP” in the “Setup” menu to “On” on the unit (p.136). If you want to configure the network parameters manually, check that you are using an IP address which is not used by other network devices in your network (p.136).
The unit cannot connect to the Internet via a wireless router (access point).	The wireless router (access point) is turned off.	Turn on the wireless router.
	The unit and the wireless router (access point) are too far apart.	Place the unit and the wireless router (access point) closer to each other.
	There is an obstacle between the unit and the wireless router (access point).	Move the unit and the wireless router (access point) in a location where there are no obstacles between them.
Wireless network is not found.	Microwave ovens or other wireless devices in your neighborhood might disturb the wireless communication.	Turn off these devices.
	Access to the network is restricted by the firewall settings of the wireless router (access point).	Check the firewall setting of the wireless router (access point).
The unit does not detect the PC.	The media sharing setting is not correct.	Configure the sharing setting and select the unit as a device to which music contents are shared (p.90).
	Some security software installed on your PC is blocking the access of the unit to your PC.	Check the settings of security software installed on your PC.
	The unit and PC are not in the same network.	Check the network connections and your router settings, and then connect the unit and the PC to the same network.
The files in the PC cannot be viewed or played back.	The files are not supported by the unit or the media server.	Use the file format supported by both the unit and the media server. For information about the file formats supported by the unit, see “Playing back music stored on media servers (PCs/NAS)” (p.90).
The files in the PC cannot be played back continuously.	Files not supported by the unit exist in the selected folder.	If the unit detects a series of unsupported files (such as images and hidden files) during playback, playback stops automatically. Do not store the unsupported files in the playback folder.
The Internet radio cannot be played.	The selected Internet radio station is currently not available.	There may be a network problem at the radio station, or the service may have been stopped. Try the station later or select another station.
	The selected Internet radio station is currently broadcasting silence.	Some Internet radio stations broadcast silence at certain of times of the day. Try the station later or select another station.
	Access to the network is restricted by the firewall settings of your network devices (such as the router).	Check the firewall settings of your network devices. The Internet radio can be played only when it passes through the port designated by each radio station. The port number varies depending on the radio station.

Problem	Cause	Remedy
The iPod does not recognize the unit when using AirPlay.	The unit is connected to a multiple SSID router.	Access to the unit might be restricted by the network separation function on the router. Connect the iPod to the SSID which can access the unit.
The application for smartphone/tablet “AV CONTROLLER” does not detect the unit.	The unit and smartphone/tablet are not in the same network.	Check the network connections and your router settings, and then connect the unit and smartphone/tablet to the same network.
No sound from the MusicCast compatible device.	The MusicCast compatible device is turned off.	Turn on the MusicCast compatible device.
	The MusicCast compatible device is not connected to the MusicCast network.	Connect the device with “MusicCast CONTROLLER”.
The MusicCast connection cannot be made on “MusicCast CONTROLLER”.	The mobile device which “MusicCast CONTROLLER” is installed is not connected to the wireless network at your home.	Connect the mobile device to the wireless router and start “MusicCast CONTROLLER”. Disable the cellular data transmission.
	The MusicCast compatible device is turned off.	Turn on the MusicCast compatible device.
“MusicCast CONTROLLER” does not detect a MusicCast compatible device.	The mobile device which “MusicCast CONTROLLER” is installed is not connected to the wireless network at your home.	Connect the mobile device to the wireless router and set the MusicCast compatible device with “MusicCast CONTROLLER”.
	The MusicCast compatible device is turned off.	Turn on the MusicCast compatible device. Enable the network standby function on the MusicCast compatible device.
Firmware update via the network is failed.	It may not be possible depending on the condition of the network.	Update the firmware via the network again or use a USB memory device (p.151).

Error indications on the front display

Message	Cause	Remedy
Access denied	Access to the PC is denied.	Configure the sharing settings and select the unit as a device to which music contents are shared (p.90).
Access error	The unit cannot access the USB device.	Turn off the unit and reconnect your USB device. If the problem persists, try another USB device.
	There is a problem with the signal path from the network to the unit.	Make sure your router and modem are turned on.
		Check the connection between the unit and your router (or hub) (p.39).
Internal Error	An internal error has occurred.	Contact the nearest authorized Yamaha dealer or service center.
No content	There are no playable files in the selected folder.	Select a folder that contains files supported by the unit.
No device	The unit cannot detect the USB device.	Turn off the unit and reconnect your USB device. If the problem persists, try another USB device.
Please wait	The unit is preparing for connecting to the network.	Wait until the message disappears. If the message stays more than 3 minutes, turn off the unit and turn it on again.
RemID Mismatch	The remote control IDs of the unit and the remote control are not identical.	Change the remote control ID of the unit or the remote control (p.148).
Remote Off	The unit cannot be operated from remote control because the remote control sensor on the main unit is turned off.	Use the controls on the front panel. To use the remote control, set "REMOTE SENSOR" in the "ADVANCED SETUP" menu to "ON" (p.148).
Unable to play	The unit cannot play back the songs stored on the USB device for some reasons.	Check the song data. If it cannot be played on another device, the song data may be defective.
	The unit cannot play back the songs stored on the PC for some reason.	Check if the format of files you are trying to play is supported by the unit. For information about the formats supported by the unit, see "Playing back music stored on media servers (PCs/NAS)" (p.90). If the unit supports the file format, but still cannot play back any files, the network may be overloaded with heavy traffic.
Update failed.	Firmware update is failed.	Update the firmware again.
USB Overloaded	An overcurrent is flowing through the USB device.	Turn off the unit and reconnect your USB device. If the problem persists, try another USB device.
Version error	Firmware update is failed.	Update the firmware again.

This section explains the technical terms used in this manual.

Audio information (audio decoding format)

Dolby Atmos

Introduced first in the cinema, Dolby Atmos brings a revolutionary sense of dimension and immersion to the Home Theater experience. Dolby Atmos is an adaptable and scalable object based format that reproduces audio as independent sounds (or objects) that can be accurately positioned and move dynamically throughout the 3 dimensional listening space during playback. A key ingredient of Dolby Atmos is the introduction of a height plane of sound above the listener.

Dolby Atmos Stream

Dolby Atmos content will be delivered to your Dolby Atmos enabled AV receiver via Dolby Digital Plus or Dolby TrueHD on Blu-ray Disc, downloadable files and streaming media. A Dolby Atmos stream contains special metadata that describes the positioning of sounds within the room. This object audio data is decoded by a Dolby Atmos AV receiver and scaled for optimum playback through Home Theater speaker systems of every size and configuration.

Dolby Digital

Dolby Digital is a compressed digital audio format developed by Dolby Laboratories, Inc. that supports 5.1-channel audio. This technology is used for audio on most DVD discs.

Dolby Digital Plus

Dolby Digital Plus is a compressed digital audio format developed by Dolby Laboratories, Inc. that supports 7.1-channel audio. Dolby Digital Plus remains fully compatible with the existing multichannel audio systems that support Dolby Digital. This technology is used for audio on BD (Blu-ray discs).

Dolby Enabled Speaker

A convenient alternative to speakers built into the ceiling, products utilizing Dolby speaker technology employ the ceiling above you as a reflective surface for reproducing audio in the height plane above the listener. Dolby enabled speakers feature a unique upward firing driver and special signal processing that can be built into a conventional speaker, or a standalone speaker module, minimally impacting the overall speaker system footprint while providing an immersive listening experience during Dolby Atmos and Dolby surround playback.

Dolby Surround

Dolby surround is a next generation surround technology that intelligently up mixes stereo; 5.1 and 7.1 content for playback through your surround speaker system. Dolby surround is compatible with traditional speaker layouts, as well as Dolby Atmos enabled playback systems that employ in-ceiling speakers or products with Dolby speaker technology.

Dolby TrueHD

Dolby TrueHD is an advanced lossless audio format developed by Dolby Laboratories, Inc. to offer a high-definition home theater experience with the quality of the studio master. Dolby TrueHD can carry up to eight channels of 96 kHz/24-bit audio (up to six channels of 192 kHz/24-bit audio) simultaneously. This technology is used for audio on BD (Blu-ray discs).

DSD (Direct Stream Digital)

DSD (Direct Stream Digital) technology stores audio signals on digital storage media, such as SACD (Super Audio CDs). The signals are stored at a high-frequency sampling rate (such as 2.8224 MHz and 5.6448 MHz). The highest frequency response is equal to or higher than 100 kHz, with a dynamic range of 120 dB. This technology offers better audio quality than that used for CDs.

DTS 96/24

DTS 96/24 is a compressed digital audio format that supports 5.1-channel and 96 kHz/24-bit audio. This format remains fully compatible with the existing multichannel audio systems that support DTS Digital Surround. This technology is used for music DVDs, etc.

DTS Dialog Control

DTS Dialog Control allows you to boost the dialog. This can be useful in noisy environments to help make the dialog more intelligible. People with impaired hearing may also benefit. Note that the content creator may disable the use of this feature in the mix, so that DTS Dialog Control may not always be available. Note that updates to your AVR may add more functionality to DTS Dialog Control or increase the range of the feature.

DTS Digital Surround

DTS Digital Surround is a compressed digital audio format developed by DTS, Inc. that supports 5.1-channel audio. This technology is used for audio on most DVD discs.

DTS-ES

DTS-ES creates total 6.1-channel audio from 5.1-channel sources that are recorded with DTS-ES. This decoder adds a surround back sound to the original 5.1-channel sound. In the DTS-ES Matrix 6.1 format, a surround back sound is recorded in the surround channels, and in the DTS-ES Discrete 6.1 format, a discrete surround back channel is recorded.

DTS Express

DTS Express is a compressed digital audio format that supports 5.1-channel audio and allows a higher compression rate than the DTS Digital Surround format developed by DTS, Inc. This technology is developed for audio streaming services on the Internet and secondary audio on BD (Blu-ray discs).

DTS-HD High Resolution Audio

DTS-HD High Resolution Audio is a compressed digital audio format developed by DTS, Inc. that supports 7.1-channel and 96 kHz/24-bit audio. DTS-HD High Resolution Audio remains fully compatible with the existing multichannel audio systems that support DTS Digital Surround. This technology is used for audio on BD (Blu-ray discs).

DTS-HD Master Audio

DTS-HD Master Audio is an advanced lossless audio format developed to offer a high-definition home theater experience with the quality of the studio master by DTS, Inc. DTS-HD Master Audio can carry up to eight channels of 96 kHz/24-bit audio (up to six channels of 192 kHz/24-bit audio) simultaneously. This technology is used for audio on BD (Blu-ray discs).

DTS Neo:6

DTS Neo:6 enables 6-channel playback from 2-channel sources. There are two modes available: “Music mode” for music sources and “Cinema mode” for movie sources. This technology provides discrete full-bandwidth matrix channels of surround sound.

DTS:X

DTS:X is the next generation object-based, multi-dimensional audio technology from DTS. Unbound from channels, DTS:X conveys the fluid movement of sound to create an incredibly rich, realistic and immersive soundscape - in front of, behind, beside and above the audience - more accurately than ever before. DTS:X offers the ability to automatically adapt the audio to the speaker layout that best fits the space, from a television’s built-in speakers to a home surround theater system to a dozen or more speakers in a commercial cinema. Immerse yourself at www.dts.com/dtsx

FLAC

FLAC is a file format for lossless audio data compression. FLAC is inferior to lossy compressed audio formats in compression rate but provides higher audio quality.

MP3

One of the compressed digital audio format used by MPEG. With psychoacoustic technologies, this compression method achieves a high compression rate. Reportedly, it is capable of compressing data quantity by about 1/10 maintaining a certain level of audio quality.

MPEG-4 AAC

An MPEG-4 audio standard. It is used for mobile telephones, portable audio players, and audio streaming services on Internet because it allows a high compression rate of data while maintaining better audio quality than MP3.

Neural:X

Neural:X is the latest downmixing/upmixing and spatial remapping technology from DTS. It is built in to DTS:X to provide upmix of Neural:X-encoded and non-encoded (PCM) data. In DTS:X for AVRs and Sound Bars, Neural:X can produce up to 11.x channels.

PCM (Pulse Code Modulation)

PCM is a signal format under which an analog audio signal is digitized, recorded, and transmitted. This technology is the basis of all other audio format. This technology is used as a lossless audio format called Linear PCM for audio on a variety of media, including CDs and BD (Blu-ray discs).

Sampling frequency/Quantization bit

Sampling frequency and quantization bits indicate the quantity of information when an analog audio signal is digitized. These values are noted as in the following example: “48 kHz/24-bit”.

- Sampling frequency

Sampling frequency (the number of times the signal is sampled per second) is called the sampling rate. When the sampling frequency is higher, the range of frequencies that can be played back are wider.

- Quantization bit

The number of quantization bits indicate the degree of accuracy when converting the sound level into a numeric value. When the number of quantized bits is higher, the expression of the sound level is more accurate.

WAV

Windows standard audio file format, which defines the method of recording the digital data obtained by converting audio signals. By default, the PCM method (no compression) is used, but you can also use other compression methods.

WMA (Windows Media Audio)

One of the compressed digital audio formats developed by Microsoft Corporation. With psychoacoustic technologies, this compression method achieves a high compression rate. Reportedly, it is capable of compressing data quantity by about 1/20 maintaining a certain level of audio quality.

Audio Information (Others)

LFE (Low Frequency Effects) 0.1 channel

This channel reproduces low-frequency bass signals and has a frequency range from 20 Hz to 120 Hz. This channel is added to the channels for all bands with Dolby Digital or DTS to enhance low frequency audio effects. This channel is labeled 0.1 because it is limited to only low frequency audio.

Lip sync

Video output sometimes lags behind audio output due to the complexity of signal processing caused by an increase in video signal capacity. Lip sync is a technique for automatically correcting the timing lag between audio and video output.

HDMI and video information

Component video signal

With the component video signal system, the video signal is separated into the Y signal for luminance and the Pb and Pr signals for chrominance. Color can be reproduced more faithfully with this system because each of these signals is independent.

Composite video signal

With the composite video signal system, color, brightness, and synchronization data signals are combined and transmitted with a single cable.

Deep Color

Deep Color is a technology that HDMI specification supports. Deep Color increases the number of available colors within the boundaries defined by the RGB or YCbCr color space. Conventional color systems process the color using 8 bits. Deep Color processes the color with 10, 12, or 16 bits. This technology allows HDTVs and other displays to increase from millions of colors to billions of colors and eliminate on-screen color banding for smooth tonal transitions and subtle gradations between colors.

HDCP

HDCP (High-bandwidth Digital Content Protection) is a digital copy protection form that prevents copying of digital contents as it travels across connections (such as HDMI).

HDMI

HDMI (High-Definition Multimedia Interface) is the world-wide standard interface for digital audio/video signal transmission. This interface transmits both digital audio and digital video signals using a single cable without any loss. HDMI complies with HDCP (High-bandwidth Digital Content Protection) and provides a secure audio/video interface. For further information on HDMI, visit the HDMI website at "<http://www.hdmi.org/>".

x.v.Color

"x.v.Color" is a technology that the HDMI specification supports. It is a more extensive color space than sRGB and allows the expression of colors that were not hitherto possible. While remaining compatible with the color gamut of sRGB standards, "x.v.Color" expands the color space, and thus can produce more vivid, natural images.

Network information

SSID

SSID (Service Set Identifier) is a name that identifies a particular wireless LAN access point.

Wi-Fi

Wi-Fi (Wireless Fidelity) is a technology that allows an electronic device to exchange data or connect to the Internet wirelessly using radio waves. Wi-Fi offers the advantage of eliminating the complexity of making connections with network cables by using wireless connection. Only products that complete Wi-Fi Alliance interoperability tests can carry the “Wi-Fi Certified” trademark.

WPS

WPS (Wi-Fi Protected Setup) is a standard established by the Wi-Fi Alliance, which allows easy establishment of a wireless home network.

Yamaha technologies

CINEMA DSP (Digital Sound Field Processor)

Since the surround sound systems were originally designed for use in movie theaters, their effect is best experienced in a theater that has many speakers designed for acoustic effects. Since home conditions (such as room size, wall material, and number of speakers) can differ so widely, it is inevitable that there are differences in the sound that you hear. Based on a wealth of actually measured data, CINEMA DSP, Yamaha’s original DSP technology provides the audiovisual experience of a movie theater in your own home.

CINEMA DSP HD³

The actually measured sound field data contain the information of the height of the sound images. CINEMA DSP HD³ feature achieves the reproduction of the accurate height of the sound images so that it creates the accurate and intensive stereoscopic sound fields in a listening room.

Compressed Music Enhancer

The Compressed Music Enhancer feature compensates for missing harmonics in compression music formats (such as MP3). As a result, this technology provides improved performance for the overall sound system.

SILENT CINEMA

Yamaha has developed a natural, realistic sound effect DSP algorithm for headphones. Parameters for headphones have been set for each sound program, so that accurate representations of all the sound programs can be enjoyed on headphones.

SURROUND:AI

The AI incorporated in the DSP analyzes scenes by focusing on sound elements such as “dialogue”, “background music”, “ambient sounds” and “sound effects” as well as instantaneously creates the optimal surround effect in real time. An expressive power beyond conventional single sound field effects maximizes the realistic feel.

Virtual CINEMA DSP

Virtual CINEMA DSP allows the system to virtually reproduce the sound field of the surround speakers with front left and right speakers. Even if the surround speakers are not connected, the unit creates the realistic sound field in a listening room.

Virtual CINEMA FRONT

Virtual CINEMA FRONT allows the system to virtually reproduce the sound field of the surround speakers with front surround speakers. Even if the surround speakers placed in the front, the unit creates the realistic sound field in a listening room.

Virtual Presence Speaker (VPS)

Virtual Presence Speaker allows the system to virtually reproduce the height of the 3D sound field without presence speakers. Even if the presence speakers are not connected, the unit creates the 3D sound field in your room.

Virtual Surround Back Speaker (VSBS)

Virtual Surround Back Speaker allows the system to virtually reproduce the sound field of the surround back speakers. Even if the surround back speakers are not connected, the unit adds a sense of depth to the rear sound field of CINEMA DSP.

Supported devices and file formats

This section explains the devices and file formats supported by the unit.

Supported devices

For information about specifications of each device, refer to the instruction manual of it.

Bluetooth device

- The unit supports Bluetooth devices that support A2DP or AVRCP.
- A Bluetooth device may not be detected by the unit or some feature may not be compatible, depending on the model.

USB devices

- This unit is compatible with USB memory devices that are in FAT16 or FAT32 format.
Do not connect any other type of USB devices.
- USB devices with encryption cannot be used.
- Some features may not be compatible, depending on the model or manufacturer of the USB storage device.

AirPlay

AirPlay works with iPhone, iPad, and iPod touch with iOS 4.3.3 or later, Mac with OS X Mountain Lion or later, and PC with iTunes 10.2.2 or later.

Made for.

iPhone 7 Plus, iPhone 7, iPhone SE, iPhone 6s Plus, iPhone 6s, iPhone 6 Plus, iPhone 6, iPhone 5s, iPhone 5c, iPhone 5, iPhone 4s

iPad Pro (10.5"), iPad Pro (12.9") 2nd Generation, iPad Pro (12.9") 1st Generation, iPad Pro (9.7"), iPad mini 4, iPad Air 2, iPad mini 3, iPad Air, iPad mini 2, iPad mini, iPad (5th generation), iPad (4th generation), iPad (3rd generation), iPad 2

iPod touch (6th generation), iPod touch (5th generation)

(as of May 2018)

File formats

For information about specifications of each file, refer to the instruction manual of your recording device or consult file's help.

USB/PC (NAS)

File	Sampling frequency (kHz)	Quantization bitrate (bit)	Bitrate	The number of channels	Gapless playback
WAV *	32/44.1/48/88.2/96/176.4/192/352.8/384	16/24/32	—	2	✓
MP3	32/44.1/48	—	8 to 320	2	—
WMA	32/44.1/48	—	8 to 320	2	—
MPEG-4 AAC	32/44.1/48	—	8 to 320	2	—
FLAC	32/44.1/48/88.2/96/176.4/192/352.8/384	16/24	—	2	✓
ALAC	32/44.1/48/88.2/96	16/24	—	2	✓
AIFF	32/44.1/48/88.2/96/176.4/192/352.8/384	16/24/32	—	2	✓
DSD	2.8 MHz/5.6 MHz/11.2 MHz	1	—	2	—

* Linear PCM format only. 32 bit-float files cannot be played back.



- To play back FLAC files stored on a PC or NAS, you need to install server software that supports sharing of FLAC files on your PC or use a NAS that supports FLAC files.
- Digital Rights Management (DRM) contents cannot be played back.
- When the sampling frequency is 352.8 kHz, playback is downsampled to 176.4 kHz; when the sampling frequency is 384 kHz, playback is downsampled to 192 kHz.
- When Pure Direct is enabled, playback at 352.8 and 384 kHz is not downsampled. In addition, when Pure Direct is enabled, input sources other than the network sources and USB cannot be delivered.

Video signal flow

Video signals input from a video device to the unit are output to a TV as shown below.

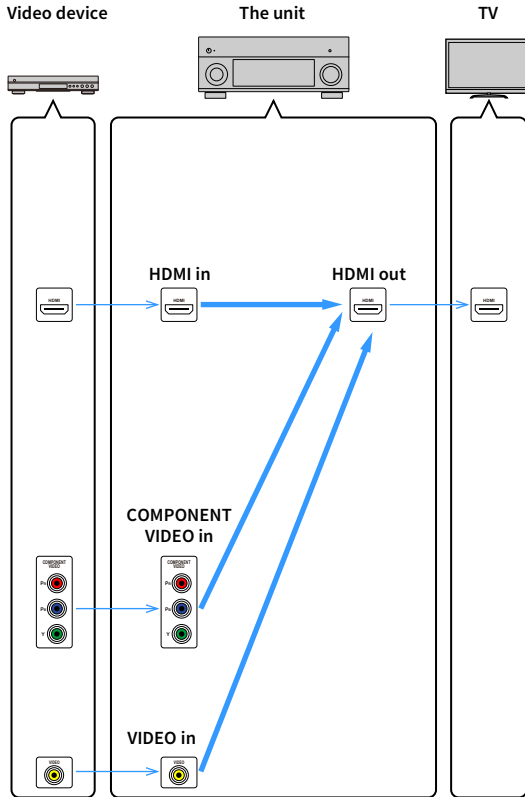

Video conversion table



- You can select the resolution and the aspect ratio applied to HDMI-output video processing in “Video Mode” (p.132) in the “Setup” menu.
- The unit does not convert 480-line and 576-line video signals interchangeably.

		HDMI out						
		Resolution	480i/576i	480p/576p	720p	1080i	1080p	4K
HDMI in	480i/576i	→	→ (*)	→ (*)	→ (*)	→ (*)	→ (*)	→ (*)
	480p/576p		→	→ (*)	→ (*)	→ (*)	→ (*)	→ (*)
	720p			→	→ (*)	→ (*)	→ (*)	→ (*)
	1080i			→ (*)	→	→ (*)	→ (*)	→ (*)
	1080p/50, 60 Hz			→ (*)	→ (*)	→	→	→
	1080p/24 Hz						→	→
	4K							→
COMPONENT VIDEO in	480i/576i	→	→ (*)	→ (*)	→ (*)	→ (*)	→ (*)	→ (*)
	480p/576p		→	→ (*)	→ (*)	→ (*)	→ (*)	→ (*)
	720p			→	→ (*)	→ (*)	→ (*)	→ (*)
	1080i			→ (*)	→	→ (*)	→ (*)	→ (*)
VIDEO in	480i/576i	→	→ (*)	→ (*)	→ (*)	→ (*)	→ (*)	→ (*)

→ : Available

* If “HDMI ZONE OUT Assign” is set to “Zone2”, conversion to 4K is possible only from 1080p. All other resolutions are pass-through.

Multi-zone output

Audio signals that can be output to Zone2, Zone3 and Zone4 vary depending on how you connect the device in each zone to the unit's output jacks.

In \ Out	ZONE OUT jacks		HDMI OUT 3 (ZONE OUT) jack	
	Zone2	Zone3	Zone2 (*1)	Zone4 (*2)
Digital audio (HDMI)	➡ (*3)		➡ (*4)	➡ (*5, 8)
Digital audio (COAXIAL/OPTICAL)	➡ (*6)	➡ (*6)	➡ (*6)	
Analog audio (AUDIO)	➡	➡	➡	
USB (*7)	➡	➡	➡	
Network sources (*7)	➡	➡	➡	
TUNER	➡	➡	➡	

➡ : Available

*1 Available when "HDMI ZONE OUT Assign" (p.135) in the "Setup" menu is set to "Zone2"
(HDMI Audio Output - HDMI ZONE OUT: On)

*2 Available when "HDMI ZONE OUT Assign" (p.135) in the "Setup" menu is set to "Zone4"

*3 Available when 2-channel PCM signals are input (stereo output [down mixed to 2-channels]
when the input source selected in the main zone is selected)

Available when "HDMI ZONE OUT Assign" (p.135) in the "Setup" menu is set to "Zone2"

*4 Available when 2-channel PCM signals are input (stereo output [down mixed to 2-channels]
when the input source selected in the main zone is selected)

*5 HDMI audio pass-through (stereo output [down mixed to 2-channels] when the input source
selected in the main zone is selected)

*6 Available when 2-channel PCM signals are input

*7 To play back DSD audio in Zone2, select "Main Zone Sync" as the Zone2 input, or use the
party mode (p.104).

*8 If the Main Zone and Zone4 share the same input, the audio format that can be received in
the Main Zone is restricted by the device connected to Zone4.

Information on HDMI

This section explains the functions related to HDMI and its signal compatibility.

HDMI Control

HDMI Control allows you to operate external devices via HDMI. If you connect a TV that supports HDMI Control to the unit with an HDMI cable, you can control the unit (such as power and volume) with TV remote control operations. You can also control external devices (such as HDMI Control-compatible BD/DVD players) connected to the unit with an HDMI cable.

Operations available from the TV's remote control

- Standby
- Volume control including mute
- Switching to input audio from the TV when the TV input is switched to its built-in tuner
- Switching to input video/audio from the selected playback device
- Switching between audio output devices (the unit or TV speaker)

(Example)

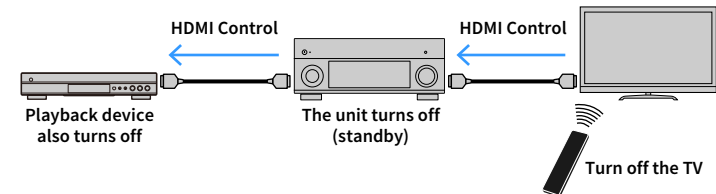

Operations available from the unit's remote control

- Starting playback on the playback device and turning on the TV with a scene selection
- Switching the TV input to display the "Setup" menu (when SETUP is pressed)
- Controlling the external device from which video is displayed on the TV (playback and menu operations)
- Controlling the TV when you select TV audio input that is set in "TV Audio Input" in the "Setup" menu
- Controlling the TV with the color (RED/GREEN/YELLOW/BLUE) keys of the remote control when "TV Control" is set for the color keys

(Example)

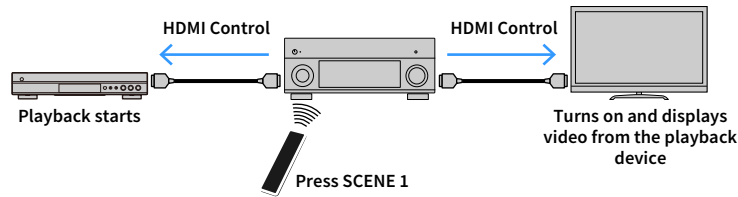

HDMI Control might not work properly. For related functions and settings, refer to the following.

- For linking with the selected scene, see "Selecting the input source and favorite settings with one touch (SCENE)" (p.64).
- For setting the jack for TV audio input, see "TV Audio Input" (p.134).
- For setting the functions of the color keys, see "Color Key" (p.144).

To use HDMI Control, you need to perform the following HDMI Control link setup after connecting the TV and playback devices.

For details on settings and operating your TV, refer to the instruction manual for the TV.



This setup is required every time you add a new HDMI Control-compatible device to your system.

1 Turn on the unit, TV, and playback devices.

2 Configure the settings of the unit.

1 Switch the TV input to display video from the unit.

2 Press SETUP.

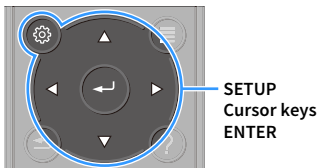

3 Use the cursor keys to select "Video/HDMI".

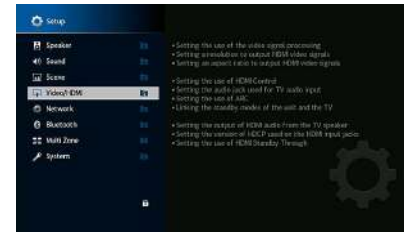

4 Use the cursor keys to select "HDMI Control" and press ENTER.

5 Use the cursor keys to select "On".

6 Press SETUP.

3 Enable HDMI Control on the TV and playback devices (such as HDMI Control-compatible BD/DVD players).

4 Turn off the main power of the TV and then turn off the unit and playback devices.

5 Turn on the unit and playback devices and then turn on the TV.

6 Check the followings.

On the unit: The input to which the playback device is connected is selected. If not, select the input source manually.

On the TV: The video from the playback device is displayed.

7 Switch the TV input to display the video from the unit.

8 Check that the unit is properly synchronized with the TV by turning off the TV or adjusting the TV volume with the TV remote control.



- If HDMI Control does not work properly, try unplugging the TV in Step 3 and plugging in the TV again in Step 4. It may solve the problem. Also, HDMI Control may not work if the number of connected devices exceeds the limit. In this case, disable HDMI Control on the devices not in use.
- If the unit is not synchronized to the TV's power operations, check the priority of the audio output setting on the TV.
- We recommend using TV and playback devices from the same manufacturer so that HDMI Control works more effectively.
- We do not assure the operation of all HDMI Control-compatible devices.

Audio Return Channel (ARC)

ARC allows you to input TV audio to the unit with the HDMI cable which transmits video signal to the TV.

Check the following after the HDMI Control settings.

- 1 Select a TV program with the TV remote control.
- 2 Check that the input source of the unit will be automatically switched to "AUDIO 1" and the TV audio will be played back on the unit.

If you cannot hear the TV audio, check the following:

- "ARC" (p.134) in the "Setup" menu is set to "On".
- The HDMI cable is connected to the ARC-compatible HDMI jack (HDMI jack marked "ARC") on the TV.

Some HDMI jack on the TV is not compatible with ARC. For details, refer to the instruction manual for the TV.



- If the audio is interrupted while using ARC, set "ARC" (p.134) in the "Setup" menu to "Off" and use an audio cable (digital optical or stereo pin cable) to input TV audio to the unit (p.33).
- When using ARC, connect a TV with an HDMI cable that supports ARC.



"AUDIO 1" is set as TV audio input at the factory. If you have connected any external device to the AUDIO 1 jacks, use "TV Audio Input" (p.134) in the "Setup" menu to change the TV audio input assignment. To use the SCENE function (p.64), you also need to change the input assignment for SCENE 7. (The settings must be changed only when SCENE 7 is used as the default (TV Viewing).)

HDMI signal compatibility

- When CPPM copy-protected DVD-Audio is played back, video/audio signals may not be output, depending on the type of the DVD player.
- The unit is not compatible with HDCP-incompatible HDMI or DVI devices. For details, refer to the instruction manual for each device.
- To decode audio bitstream signals on the unit, set the input source device appropriately so that the device outputs the bitstream audio signals directly (does not decode the bitstream signals on the playback device). For details, refer to the instruction manual for the playback device.

Trademarks



Manufactured under license from Dolby Laboratories. Dolby, Dolby Atmos, Dolby Surround, Dolby Vision, and the double-D symbol are trademarks of Dolby Laboratories.



For DTS patents, see <http://patents.dts.com>. Manufactured under license from DTS, Inc. DTS, the Symbol, DTS in combination with the Symbol, DTS:X, and the DTS:X logo are registered trademarks or trademarks of DTS, Inc. in the United States and/or other countries. © DTS, Inc. All Rights Reserved.



Use of the Works with Apple badge means that an accessory has been designed to work specifically with the technology identified in the badge and has been certified by the developer to meet Apple performance standards.

Apple, iPad, iPad Air, iPad Pro, iPhone, and iTunes are trademarks of Apple Inc., registered in the U.S. and other countries.

The trademark "iPhone" is used in Japan with a license from Aiphone K.K.

App Store is a service mark of Apple Inc.



The Bluetooth® word mark and logos are registered trademarks owned by Bluetooth SIG, Inc. and any use of such marks by Yamaha Corporation is under license.



Digital Audio Broadcasting



Digital Audio Broadcasting

(Australia, U.K., Europe, Middle East and Russia models)

The unit supports DAB/DAB+ tuning.



The terms HDMI, the HDMI Logo, and High-Definition Multimedia Interface are trademarks or registered trademarks of HDMI Licensing LLC in the United States and other countries.

x.v.Color™

"x.v.Color" is a trademark of Sony Corporation.

Windows™

Windows is a registered trademark of Microsoft Corporation in the United States and other countries.

Internet Explorer, Windows Media Audio and Windows Media Player are either registered trademarks or trademarks of Microsoft Corporation in the United States and/or other countries.

Android™ Google Play™

Android and Google Play are trademarks of Google Inc.

Blu-ray is a trademark of the Blu-ray Disc Association.



The Wi-Fi CERTIFIED™ Logo and Wi-Fi Protected Setup are certification marks of Wi-Fi Alliance®.

Wi-Fi, Wi-Fi CERTIFIED, Wi-Fi Protected Setup and WPA2 are registered trademarks or trademarks of Wi-Fi Alliance®.



MusicCast is a trademark or registered trademark of Yamaha Corporation.



Yamaha Eco-Label is a mark that certifies products of high environmental performance.



"SILENT CINEMA" is a trademark of Yamaha Corporation.

Google Noto Fonts

This product uses the following fonts.

Copyright © June 2015, Google
(<https://www.google.com/get/noto/#sans-lgc>), with Reserved Font Name Noto Sans Version 1.004.

Copyright © June 2015, Google
(<https://www.google.com/get/noto/help/cjk/>), with Reserved Font Name Noto Sans CJK Version 1.004.

This Font Software is licensed under the SIL Open Font License, Version 1.1.

This license is available with a FAQ at: <http://scripts.sil.org/OFL>

Explanations regarding GPL

This product utilizes GPL/LGPL open-source software in some sections. You have the right to obtain, duplicate, modify, and redistribute this open-source code only. For information on GPL/LGPL open source software, how to obtain it, and the GPL/LGPL license, refer to the Yamaha Corporation website (<https://download.yamaha.com/sourcecodes/musiccast/>).

Licenses

For information on the licenses of the third-party software in this product, refer to the following.

[http://\(IP address of this product*\)/licenses.html](http://(IP address of this product*)/licenses.html)

* IP address of this product is checked with MusicCast CONTROLLER.

Input jacks

- Analog Audio
 - Audio (Unbalance) x 9 (AV 1-4, AUDIO 1-3, PHONO, AUX)
 - Audio (Balance) x 1 (AUDIO 4) (1:GND, 2:HOT, 3:COLD)
 - MULTI CH INPUT x 1 (8 ch)
- Digital Audio
 - Optical x 3 (AV 3, AUDIO 1-2)
(Supported sampling frequencies: 32 kHz to 96 kHz)
 - Coaxial x 3 (AV 1-2, AUDIO 3)
(Supported sampling frequencies: 32 kHz to 192 kHz)
- Video
 - Composite x 4 (AV 1-4)
 - Component x 2 (AV 1-2)
- HDMI Input
 - HDMI x 7 (AV 1-7)
- Others
 - USB x 1 (USB2.0)
 - NETWORK x 1 (100Base-TX/10Base-T)

Output jacks

- Analog Audio
 - Pre Out (Unbalance) x 11 (FRONT L/R, CENTER, SURROUND L/R, SURROUND BACK L/R, F.PRESENCE L/R, R.PRESENCE L/R)
 - Pre Out (Balance) x 11 (FRONT L/R, CENTER, SURROUND L/R, SURROUND BACK L/R, F.PRESENCE L/R, R.PRESENCE L/R) (1:GND, 2: HOT, 3: COLD)
 - Subwoofer Out (Unbalance) x 2
(SUBWOOFER 1-2, Stereo/Front&Rear/Monox2)
 - Subwoofer Out (Balance) x 2
(SUBWOOFER 1-2, Stereo/Front&Rear/Monox2)
 - ZONE OUT x 2 (ZONE2/ZONE3)
 - Headphone x 1

Other jacks

- YPAO MIC x 1
- REMOTE IN x 1
- REMOTE OUT x 1
- TRIGGER OUT x 2
- RS-232C x 1

HDMI

- HDMI Features
 - 4K UltraHD Video (include 4K/60, 50Hz 10/12bit)
 - 3D Video
 - eARC (Enhanced Audio Return Channel)
 - HDMI Control (CEC)
 - Auto Lip Sync
 - Deep Color
 - x.v.Color
 - HD audio playback
 - Selectable HDMI input in HDMI standby mode
- Video Format (Repeater Mode)
 - VGA
 - 480i/60 Hz
 - 576i/50 Hz
 - 480p/60 Hz
 - 576p/50 Hz
 - 720p/60 Hz, 50 Hz
 - 1080i/60 Hz, 50 Hz
 - 1080p/60 Hz, 50 Hz, 30 Hz, 25 Hz, 24 Hz
 - 4K/60 Hz, 50Hz, 30 Hz, 25 Hz, 24 Hz

- Supported Audio Formats
 - Dolby Atmos
 - DTS:X
 - Dolby TrueHD
 - Dolby Digital Plus
 - Dolby Digital
 - DTS-HD Master Audio
 - DTS-HD High Resolution
 - DTS Express
 - DTS
 - DSD 2-ch to 6-ch
 - PCM 2-ch to 8-ch (Max. 192 kHz/24 bit)
- Content Protection: HDCP compatible
(HDMI [AV 1-7]: HDCP 2.2 compatible)

TUNER

- Analog Tuner
 - [Australia model]
 - DAB/FM x 1 (TUNER)
 - [U.K., Europe, Middle East and Russia models]
 - DAB/FM with Radio Data System x 1 (TUNER)
 - [Other models]
 - FM/AM x 1 (TUNER)

USB

- Capable of Mass Storage Class USB Memory
- Current Supply Capacity: 1 A

Bluetooth

- Sink Function
 - Source Device to AVR (ex. Smartphone/Tablet)
- Capable of Play/Stop Operation from Sink Device
- Bluetooth Version Ver. 4.2
- Supported Profile
 - Sink Function A2DP, AVRCP
- Supported Codec
 - Sink Function SBC, AAC
- Wireless Output Bluetooth Class 2
- Maximum Communication Distance 10 m (33 ft)

MusicCast

- Controlled by MusicCast Application (iOS, Android)
- MusicCast Link ClientMain, Zone2, Zone3
- MusicCast Link Master (Input Source).....NET/USB/Bluetooth, Analog External Input, Digital External Input, Zone2
- Network ConnectivityExtend Mode, Connect

Network

- PC Client Function
- AirPlay supported
- Internet Radio
- Wi-Fi function
 - Capable of WPS by PIN Method and Push-Button-Method
 - Capable of sharing with iOS devices by wireless connection and USB connection
 - Available Security Method: WEP, WPA2-PSK (AES), Mixed Mode
 - Radio Frequency Band: 2.4/5 GHz
 - Wireless LAN Standards: IEEE 802.11 a/b/g/n/ac*
 - * 20 MHz channel bandwidth only

Compatible Decoding Formats

- Decoding Format
 - Dolby Atmos
 - Dolby TrueHD, Dolby Digital Plus
 - DTS:X
 - Dolby Digital, Dolby Digital EX
 - DTS
 - DTS-HD Master Audio, DTS-HD High Resolution, DTS Express
 - DTS 96/24, DTS-ES Matrix 6.1, DTS-ES Discrete 6.1
- Post Decoding Format
 - Dolby Surround
 - DTS Neo:6 Music, DTS Neo:6 Cinema

Audio Section

- Input Sensitivity / Input Impedance
 - PHONO 3.5 mV/47 k Ω
 - RCA Unbalance (Audio 2 etc.) 200 mV/47 k Ω
 - XLR Balance (Audio 4)
 - Attenuator Off..... 200 mV/200 k Ω
 - Attenuator On..... 400 mV/200 k Ω

- Maximum Input Signal
 - PHONO 45 mV
 - RCA Unbalance (Audio 2 etc.) 2.4 V
 - XLR Balance (Audio 4)
 - Attenuator Off 2.4 V
 - Attenuator On 4.8 V
- Rated Output Level/Impedance (RCA Unbalance Preout)
 - Front L/R 1.0 V/470 Ω
 - Center 1.0 V/470 Ω
 - Surround L/R 1.0 V/470 Ω
 - Surround Back L/R 1.0 V/470 Ω
 - Front Presence L/R 1.0 V/470 Ω
 - Rear Presence L/R 1.0 V/470 Ω
 - Subwoofer 1–2 1.0 V/470 Ω
 - Zone2/Zone3 1.0 V/470 Ω
- (XLR Balance Preout)
 - Front L/R 2.0 V/470 Ω
 - Center 2.0 V/470 Ω
 - Surround L/R 2.0 V/470 Ω
 - Surround Back L/R 2.0 V/470 Ω
 - Front Presence L/R 2.0 V/470 Ω
 - Rear Presence L/R 2.0 V/470 Ω
 - Subwoofer 1–2 2.0 V/470 Ω
- Maximum Output Level (0.06%THD) (RCA Unbalance Preout)
 - Front L/R 4.0 V
 - Center 4.0 V
 - Surround L/R 4.0 V
 - Surround Back L/R 4.0 V
 - Front Presence L/R 4.0 V
 - Rear Presence L/R 4.0 V
 - Subwoofer 1–2 6.5 V
 - Zone2/Zone3 4.0 V

- (XLR Balance Preout)
 - Front L/R 8.0 V
 - Center 8.0 V
 - Surround L/R 8.0 V
 - Surround Back L/R 8.0 V
 - Front Presence L/R 8.0 V
 - Rear Presence L/R 8.0 V
 - Subwoofer 1–2 13.0 V
- Headphone Impedance 16 Ω or more
- Frequency Response
 - AUDIO 2 etc. (10 Hz to 100 kHz) +0/-3 dB
- RIAA Equalization Deviation
 - PHONO (20 Hz to 20 kHz) 0 \pm 0.5 dB
- Total Harmonic Distortion (Pure Direct, 1 V)
 - PHONO to PreOut (RCA Unbalance) (1 kHz) 0.008% or less
 - AUDIO 2 etc. to PreOut (RCA Unbalance) (20 Hz to 20 kHz) 0.008% or less
 - AUDIO 2 etc. to PreOut (XLR Balance) (20 Hz to 20 kHz) 0.008% or less
- Signal to Noise Ratio (IHF-A Network) (Pure Direct, Input 1 kW Shorted)
 - PHONO to PreOut (XLR Balance/RCA Unbalance) 95 dB or more
 - AUDIO 2 etc. to PreOut (XLR Balance/RCA Unbalance) 112 dB or more
- Residual Noise (IHF-A Network)
 - Preout (RCA Unbalance) 2.5 μ V or less
 - Preout (XLR Balance) 5.0 μ V or less
- Channel Separation (Input 1 k Ω Shorted, 1 kHz/10 kHz)
 - PHONO 86 dB/68 dB or more
 - AUDIO 2 etc. 86 dB/68 dB or more
- Maximum Gain (Volume: Maximum)
 - Main Zone Preout 14 dB
 - Zone2/Zone3 Preout 14 dB
- Volume Control
 - Main Zone MUTE, -80 dB to +16.5 dB (0.5 dB Step)
 - Zone2/Zone3 MUTE, -80 dB to +16.5 dB (0.5 dB Step)

- Tone Control Characteristics

- Main Zone

- Bass Boost/Cut ±6.0 dB/50 Hz (0.5 dB Step)
 - Bass Turnover..... 350 Hz
 - Treble Boost/Cut..... ±6.0 dB/20 kHz (0.5 dB Step)
 - Treble Turnover..... 3.5 kHz

- Zone2/Zone3

- Bass Boost/Cut ±6.0 dB/50 Hz (0.5 dB Step)
 - Bass Turnover..... 350 Hz
 - Treble Boost/Cut..... ±6.0 dB/20 kHz (0.5 dB Step)
 - Treble Turnover..... 3.5 kHz

- Filter Characteristics

- ($f_c=40/60/80/90/100/110/120/160/200$ Hz)

- H.P.F. (Front, Center, Surround, Surround Back: Small)

- 12 dB/oct.

- L.P.F. (Subwoofer) 24 dB/oct.

- Optical/Coaxial Jack Support fs

- Optical Jack Support fs 32 kHz-96 kHz

- Coaxial Jack Support fs 32 kHz-192 kHz

Video Section

- Video Signal Type NTSC/PAL/SECAM

- Video Signal Level

- Composite..... 1 Vp-p/75 Ω

- Component

- Y..... 1 Vp-p/75 Ω

- Pb/Pr..... 0.7 Vp-p/75 Ω

- Video Maximum Input Level..... 1.5 Vp-p or more

FM Section

- Tuning Range

- [U.S.A. and Canada models]87.5 MHz to 107.9 MHz

- [Brazil, Asia, Taiwan, Central and South America and General models]

-87.5/87.50 MHz to 108.0/108.00 MHz

- [U.K., Europe and Russia models] 87.50 MHz to 108.00 MHz

- [Other models] 87.50 MHz to 108.00 MHz

- 50 dB Quiet Sensitivity (IHF, 1 kHz, 100% MOD.)

- Monaural 3 μV (20.8 dBf)

- Signal to Noise Ratio (IHF)

- Monaural/Stereo69 dB/68 dB

- Harmonic Distortion (IHF, 1 kHz)

- Monaural/Stereo 0.5%/0.6%

- Antenna Input 75 Ω unbalanced

AM section (except Australia, U.K., Europe, Middle East and Russia models)

- Tuning Range

- [U.S.A. and Canada models]530 kHz to 1710 kHz

- [Brazil, Asia, Taiwan, Central and South America and General models]

-530/531 kHz to 1710/1611 kHz

- [Other models]531 kHz to 1611 kHz

DAB section (Australia, U.K., Europe, Middle East and Russia models)

- Tuning Range 174 MHz to 240 MHz (Band III)

- Support Audio FormatMPEG-1 Layer II/MPEG-4 HE-AAC v2

- Antenna 75 Ω unbalanced

General

- Power Supply

- [U.S.A. and Canada models]AC 120 V, 60 Hz

- [Brazil and Central and South America models]

- AC 110 to 120 V, 50/60 Hz

- [Taiwan model] AC 110 to 120 V, 50/60 Hz

- [China model]AC 220 V, 50 Hz

- [Korea model]AC 220 V, 60 Hz

- [Other model] AC 220 to 240 V, 50/60 Hz

- Standby Power Consumption

- HDMI Control Off, Standby Through Off, Network Standby Off

- 0.1 W

- HDMI Control On, Standby Through On (No Signals),

- Network Standby Off..... 1.4 W

- HDMI Control Off, Standby Through Off, Network Standby On,

- Bluetooth Standby Off

- Wired..... 1.4 W

- Wireless (Wi-Fi) 1.6 W

- HDMI Control Off, Standby Through Off,

- Network Standby On (Wired), Bluetooth Standby On..... 1.4 W

- HDMI Control On, Standby Through On, Network Standby On

- (Wi-Fi), Bluetooth Standby On..... 2.5 W

- Power Consumption 65 W

- Power Consumption (No Signals) 35 W

- Dimensions (W x H x D)

- 435 x 193 x 474 mm (17-1/8" x 7-1/2" x 18-5/8")

- * Including legs and protrusions

- Reference Dimensions (W x H x D) (with wireless antenna upright)

- 435 x 270 x 474 mm (17-1/8" x 10-5/8" x 18-5/8")

- * Including legs and protrusion

- Weight 15.2 kg (33.5 lbs)

* The contents of this manual apply to the latest specifications as of the publishing date. To obtain the latest manual, access the Yamaha website then download the manual file.

Yamaha Global Site
<https://www.yamaha.com/>
Yamaha Downloads
<https://download.yamaha.com/>

Manual Development Group
© 2018 Yamaha Corporation

Published 07/2018 AM-A0

AV17-0237