

T+A

User manual

CALA[®] CDR

Welcome.

We are delighted that you have decided to purchase a **T+A** product. With your new **CALA CDR** you have acquired a top-quality piece of equipment which has been designed and developed with the wishes of discerning listeners as absolute top priority.

This system represents our very best efforts at designing practical electronic equipment incorporating solid quality, user-friendly operation and a specification and performance which leaves nothing to be desired.

All these factors contribute to a piece of equipment which will satisfy your highest demands and your most searching requirements for a period of many years. All the components we use meet the German and European safety norms and standards which are currently valid. All the materials we use are subject to painstaking quality monitoring.

At all stages of production we avoid the use of substances which are environmentally unsound or potentially hazardous to health, such as chlorine-based cleaning agents and CFCs.

We also aim to avoid the use of plastics in general, and PVC in particular, in the design of our products. Instead we rely upon metals and other non-hazardous materials; metal components are ideal for recycling, and also provide effective electrical screening.

Our robust all-metal cases exclude any possibility of external sources of interference affecting the quality of reproduction. From the opposite point of view our products' electro-magnetic radiation (electro-smog) is reduced to an absolute minimum by the outstandingly effective screening provided by the metal case.

Our range of accessories includes high-quality cables and connectors

We would like to take this opportunity to thank you for the faith you have shown in our company by purchasing this product, and wish you many hours of enjoyment and sheer listening pleasure with your **CALA CDR**.

T+A elektroakustik GmbH & Co KG

roon
ready

airable
by TUNING

TIDAL

DEEZER

qobuz



License Notice

This product contains software in form of object code that is partially based on free software under different licenses, especially the GNU General Public License. You can find details on this in the License Information which you should have received with this product.

If you have not received a copy of the GNU General Public License, please see <http://www.gnu.org/licenses/>.

For a period of three years after last distribution of this product or its firmware, T+A offer the right to any third party to obtain a complete machine-readable copy of the corresponding source code on physical storage medium (DVD-ROM or USB stick) for a charge of 20€. To obtain such copy of the source code, please write to the following address including information about product model and firmware version: T+A elektroakustik, Planckstr. 9-11, 32052 Herford, Germany. The GPL license and further information about Licenses can be found on the internet under this link:

<http://www.ta-hifi.com/license-information/>

About these instructions

All the controls and functions of the **CALACDR** which are frequently used are described in the first section of these operating instructions.

The second part '**Basic settings, Installation, Using the system for the first time**' covers connections and settings which are very seldom required; they are generally required only when the machine is set up and used for the first time. Here you will also find a detailed description of the network settings required for connecting the **CALACDR** to your home network.

Symbols used in these instructions



Caution!

Text passages marked with this symbol contain important information which must be observed if the machine is to operate safely and without problems.



This symbol marks text passages which provide supplementary notes and background information; they are intended to help the user understand how to get the best out of the machine.

Notes on software updates

Many features of the **CALACDR** are software based. Updates and new features will be made available from time to time. The update process takes only a few minutes. See the chapter entitled "Software update" for how to update your device via the internet connection.

We recommend you to check for updates before using your **CALACDR** for the first time. To keep your device up to date you should check for updates from time to time.



The operation instructions, the connection guidance and the safety notes are for your own good - please read them carefully and observe them at all times. The operating instructions are an integral part of this device. If you ever transfer the product to a new owner please be sure to pass them on to the purchaser to guard against incorrect operation and possible hazards.



All the components we use meet the German and European safety norms and standards which are currently valid. This product complies with the EU directives. The declaration of conformity can be downloaded from **www.ta-hifi.com/DoC**.

Contents

CALA CDR Audio System	8
Display	8
Screen symbols and their meaning	9
Remote Control	10
Basic Functions of the Cala	13
Source switching	13
Volume control	13
Switching outputs	13
Tone settings (Tone menu).....	13
Balance.....	14
Loudness	14
Tone Control	14
Treble	14
Mid.....	14
Bass.....	14
Subwoofer.....	14
Contour Presence	14
Contour Fundamental tone.....	15
Mode of operation	15
Stereo / Virtual Surround.....	15
Status indicator	15
Basic settings of the CALA CDR	16
Calling up and operating the menu.....	16
Speaker	16
Source settings	17
Display brightness.....	19
Display mode	19
Ambient brightness	19
Ambient colour	19
Ambient colour cycling	19
Language.....	20
Device name.....	20
Network	20
Music services	20
Bandwidth limit.....	20
Energy saver.....	21
Update	21
Alarm Timer	22
Alarm function.....	22
Switching the Timer off.....	22
Quick selection menu.....	22
Alarm Timer menu.....	23
Menu item	23

Alarm	23
Alarm Time.....	23
Alarm Source	23
Alarm Vol.	23
Time Mode	23
Set Time.....	24
Show clock	24
Brightness Clock	24
Slumber-function	24
Activate slumber function	24
Change the slumber time	24
Turn off slumber function.....	24
Operating the sources in detail	25
Favourites lists.....	25
General information.....	25
Calling up the Favourites list	25
Adding a favourite	25
Erasing a favourite from the Favourites list.....	26
Selecting a favourite from the list.....	26
Directly selecting a favourite.....	26
Sorting Favourites lists	26
Operating the radio	28
FM - Radio	28
Selecting FM radio	28
General	28
Manual station search	28
Automatic station search	29
Selecting a station from the Station list	29
RDS functions	29
Switching Radio Text on and off	30
Mono / Stereo.....	30
DAB - Radio	30
Selecting DAB radio	30
Display	30
Automatic station search	31
Selecting a station from the Station list	31
RDS functions	32
Internet-Radio.....	32
Selecting Internet Radio as source	32
Selecting podcasts	32
Playback	32
Favourites lists	33
Search function	33
Operating music services	34
General information.....	34
Selecting the music service	34
Playback	34
Search function	35

Playlists and favourites	35
Operating the UPnP / DLNA source (Streaming Client)	36
General information on the streaming client	36
Selecting the UPnP/DLNA source	36
Playback	36
Playback of directories	37
Search function	37
Playing USB memory media (USB Media source)	38
General information.....	38
Selecting USB Media as source	38
Playback	38
Playback of directories	39
Search function	39
Operating the Bluetooth Receiver.....	40
Selecting Bluetooth	40
Setting up audio transfer	40
Playback functions	40
Volume adjustment	41
Notes	41
Operating the Disc player	42
Selecting CD as source	42
Inserting a CD	42
Playing a CD	43
Variations.....	43
Track Select.....	43
During playback	43
Fast Search	43
CD Text.....	43
Playback mode	44
Repeat	44
Mix mode	44
Playback Program.....	45
Creating a Playback Program.....	45
Playing a playback program	45
Erasing a playback program.....	45
The Cala as D/A Converter	46
General Information on D/A Converter Operation	46
D/A Converter Operation	46
Selecting a D/A Converter Source.....	46
Front panel display.....	46
Playback with 	46
General information.....	46
Playback	46
Installation, Using the system for the first time, Safety notes	47
Back panel connections.....	48

Installation and wiring	51
Loudspeaker and signal cables	52
Safety notes	53
Network Configuration	56
The Configuration for a Wired Ethernet LAN or Power-Line LAN connection	58
Setting the Parameters for a Wired Network.....	58
The Configuration for a WLAN connection	60
Setting the parameters for a wireless network	60
Selecting and connecting a WLAN by hand	60
Searching for and Selecting the Network	60
Entering the Password (for encoded networks)	60
Storing Network Settings and Restarting	61
Connecting to WLAN via the WPS-function	61
WPS-function	61
Connecting WLAN automatically via the WPS function.....	61
Selecting the WLAN manually and connecting via WPS.....	61
Trouble shooting	63
Software update	65
Software update generally.....	65
Updating via the Internet	65
Notes on Energy Saving	66
General information.....	66
Automatic power-down (Energy saver)	66
Legal Information	66
Appendix A	67
Wiring diagram	67
Appendix B	70
Specification	70

IMPORTANT! CAUTION!

This product contains a laser diode of higher class than 1. To ensure continued safety, do not remove any covers or attempt to gain access to the inside of the product.
Refer all servicing to qualified personnel.



CALA CDR Audio System



All the functions of the **CALA CDR** are operated using the **SRC1** remote control handset. Direct-access buttons are provided for the essential functions such as source select and track select, whereas less frequently required functions are controlled by means of menus which are called up using the **sys** button.

Display

All information relating to machine status, the current music track and list navigation is displayed on the graphic screen of the **CALA CDR**. The display is context-sensitive, and in part varies according to the capabilities and facilities of the service to which you are currently listening.

The most important information is highlighted on the screen according to context. Supplementary information is provided by symbols above and below the main data.

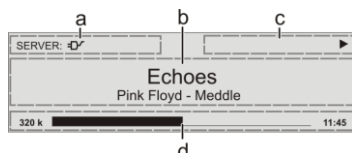

e.g.

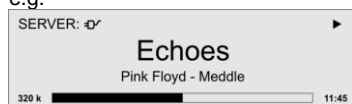

The basic areas of the screen:

- Display field (a) shows the currently active source.
- Display field (b) shows information relating to the piece of music being played. The essential information is displayed enlarged in the main line.

- Display field (c) shows information relating to the device and playback.
- The bottom line (d) displays supplementary context-sensitive information (e.g. sampling frequency, elapsed time)















The **CALA CDR** provides different screen displays for the Streaming Client and the radio.

- **Large-format display:**
Enlarged display of the most important information, clearly legible even from a distance
- **Detail display:**
Small-text display showing a large number of additional information points, e.g. bit-rate etc.

A long press on the **sys**-button on the remote control handset is used to switch between the display modes.

Screen symbols and their meaning

	<p>Making connection (Wait / Busy)</p> <p>The rotating symbol indicates that the CALA CDR is currently processing a command, or is attempting to connect to a service. These processes may take some time to complete depending on the speed of your network and the load upon it.</p> <p>During such periods the CALA CDR may be muted, and may not respond to the controls. Please wait until the symbol disappears, then try again.</p>
	<p>Indicates a music track which can be played, or a playlist.</p>
	<p>Indicates a folder which conceals further folders or lists.</p>
	<p>Indicates that a source is being reproduced via a cable connection.</p>
	<p>Indicates that a source is being reproduced via a radio connection.</p>
	<p>Indicates that the CALA CDR is reproducing a station or playing back a music track.</p>
	<p>Pause indicator</p>
	<p>Indicates that the speakers are switched off.</p>
	<p>Buffer display (fullness indicator, memory display) and data rate indicator (if available): The higher the data rate, the better the quality of reproduction.</p>
	<p>Display of the elapsed playback time. This information is not available for all services.</p>
	<p>Indicates that the  button can be used to switch to a higher menu or select level.</p>
0 / 0	<p>Position indicator in select lists. The first number shows the current position in the list, the second number the total number of list entries (length of list).</p>
ABC abc 123	<p>Display of the symbol input modes</p>
 8:30	<p>Indicates that an alarm time is set and active</p>









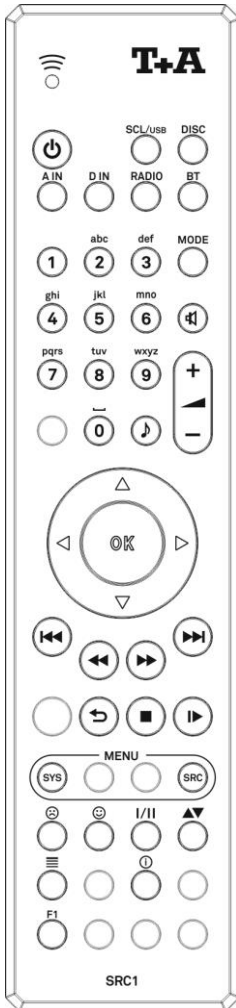







Remote Control

















Introduction









The infrared receiver for the remote control handset is located left of the screen area. There must be line of sight contact between the **SRC1** and the screen.

The following tables show the remote control buttons (only the used buttons) and their function when operating the machine.



 (red)	Switches the machine on and off
	Selects the SCL function (e.g. access to music servers, streaming services or similar), or selects the USB Media function (connected USB memory media) of the streaming client. Press this button repeatedly until the desired source appears on the screen.
	Selects the CD-Player function.
	A brief press on this button selects the analogue input you wish to use. Press the button repeatedly until the desired input is displayed on the screen.
	A brief press on this button selects the digital input you wish to use. Press the button repeatedly until the desired input is displayed on the screen.
	Selects FM, DAB, or Internet radio as source. Press this button repeatedly until the desired source appears on the screen.
	Selects the Bluetooth function
  abc ...  xyz  _	Direct alpha-numeric input, e.g. track number, quick station select, radio station. The buttons  and  are also assigned special characters. During the text input procedure you can use the  button to toggle between numeric and alpha-numeric input, and between capitals and lowercase letters.
 (green)	Switching between the following modes of operation: STEREO and VIRTUAL SURROUND.
 (yellow)	Switches sound on and off (MUTING) A brief press switches the speaker outputs on and off. A long press switches the analogue output (preout / headphones) on and off.

 (yellow)	Reduces / increases volume (volume control rocker)
  	<p>Menu</p> <p>A brief press: Opens the “System configuration” menu. (for details see Chapter “Basic settings of the CALA CDR”)</p> <p>A long press: Opens the Alarm timer menu.</p> <p>Opens the setup menu for the source device just selected. (Not all sources have their own Setup menu.)</p> <p>Tone settings</p> <p>Brief press opens the tone control settings menu:</p>
    	<p>Navigation</p> <p>Returns to the previous point / change button</p> <p>Confirms the input / change button</p> <p>Selects the next point within a list / select button</p> <p>Selects the previous point within a list / select button</p> <p>Confirmation button during input procedures</p>
      	<p>Playback functions</p> <p>Starts playback (Play function) During playback: halts (Pause) or resumes playback</p> <p>A brief press stops playback. A brief press while disc is stopped opens and closes the disc drawer.</p> <p>During menu navigation: a brief press takes you back (higher) by one menu level or aborts the current input process; the change is then abandoned.</p> <p>Selects the previous track during playback.</p> <p>Selects the next track during playback.</p> <p>Rewind to search for a particular passage. FM Radio: Manual station search</p> <p>Fast-forward to search for a particular passage. FM Radio: Manual station search</p> <p>Repeat functions (not possible with all media) Brief press: Repeat Track, Repeat ALL, 'Normal' Long press: <i>Mix-Mode</i> (Shuffle) ON / OFF Brief button presses in MIX mode: Mix, Repeat Track, Repeat Mix</p>

	<p>Adds a favourite to the Favourites list. CD - player: Activates playback programming Adds a <i>track</i> to the <i>playback program</i> during playback programming</p>
	<p>Long press: Removes a favourite from the Favourites list. CD - player: A Long press erases the <i>playback program</i>.</p>
	<p>Button for switching between Stereo and Mono reception (only FM Radio) The Stereo setting is constantly displayed in the screen window by a  symbol. The Mono setting is constantly displayed in the screen window by a  symbol.</p>
	<p>Switches between numeric and alpha-numeric input, and between capitals and lower case when pressed (repeatedly)</p> <p>Calls up the search function for SCL, USB-Media, Internetradio, Podcasts and Music services.</p> <p>Activates the sort function within a Favourites list.</p>
	<p>Displays the Favourites list created on the CALA CDR</p>
	<p>Switches the display from the track list / station list navigation to the ‚Now Playing‘ view. Switches the Radiotext / CD-text function ON/OFF. A long press toggles between different screen displays.</p>



CALA CDR can be controlled by the **T+A** App 'TA Control' too.
For further information please visit our homepage
www.ta-hifi.com

For Apple
(iOS)



For Android



Basic Functions of the Cala

The basic functions of the CALA CDR, described in this chapter are always available, regardless of the selected source.

Source switching

The source buttons are used to select the desired internal source (DISC, FM Radio, DAB Radio, USB Media, Streaming Client or Internet Radio) or an external source (Analog In 1, Analog In 2, Bluetooth, Digital 1 -3) for playback.

Once the CALA CDR has switched to the internal sources they can be operated using the remote control.

Please refer to the following chapters for details of operating the individual source devices.

 Sources which are not in use can be disabled in the System Configuration menu. This can make it easier to select the correct source (see chapter entitled "Basic settings of the CALA CDR").

Volume control

The volume of the CALA CDR can be adjusted in fine increments using the -  + button. A brief press on one volume button increases or reduces the volume by one increment. Holding one of the volume buttons pressed in causes the volume to change continuously.

Switching outputs

The loudspeaker outputs and the analogue output (Analog OUT) of the CALA CDR can be switched on and off separately using the  button.

To switch the analogue output on or off, hold the  button pressed in.

Briefly pressing the button switches the speaker outputs on and off.

Tone settings (Tone menu)

The CALA CDR features a range of facilities for adjusting the sound to suit your personal preferences, the system's location and your room acoustics. All sound settings are grouped together in the tone control menu (TONE menu).

The tone control menu is called up using the  button.

The features of the tone control menu are explained in detail in the next section.

	Adjustment range / Options:	Explanations:
Balance	-85 ... 0 ... +85	This menu point allows you to alter the balance between the left and right loudspeakers in order to compensate for an unfavourable listening position.
Loudness	off / on	The CALACDR features a volume-dependent tone control (LOUDNESS) which compensates for the frequency-dependent sensitivity of the human ear, and therefore of human hearing, at very low volume levels. This set-up option is used to switch loudness on or off.
Tone Control	off / on	This menu point can be used to disable (bypass) the CALACDR 's tone controls. To switch off the tone controls, select the "OFF" setting. When the tone controls are switched off, any adjustments you made to the following menu points "BASS" and "TREBLE" have no effect.
Treble	-12 ... 0 ... +12	This menu point allows you to alter the treble setting.
Mid	-6 ... 0 ... +6	This menu point allows you to alter the midrange setting.
Bass	-12 ... 0 ... +12	This menu point allows you to alter the bass setting.
Subwoofer (This menu point only appears if an external subwoofer is switched on in the System Configuration menu / Loudspeaker menu.)	-15 ... 0 ... +15	The volume of the subwoofer can be adjusted at this point. Adjust the volume of the subwoofer to suit the acoustic conditions of the listening room, and the volume of the other channels.
Contour Presence	-5 / -4 / ... / 0 / ... / +3	The purpose of this menu point is to adjust the Contour filter for the Presence range. This option enables you to improve speech intelligibility in spoken word programmes, documentaries and sport transmissions.

**Contour
Fundamental
tone**

-3 / -2 / -1 / 0 / +1 / +2

The purpose of this menu point is to adjust the Contour filter for the fundamental tone. If you prefer a warmer sound image, amplify the fundamental sound (+1 ... +2). For a cooler sound image, or to eliminate resonance effects, the fundamental tone should be reduced (-1 ... -3).

Mode of operation

**Stereo /
Virtual
Surround**

The CALA CDR offers two modes of operation: **STEREO** and **VIRTUAL SURROUND**. In contrast to Stereo mode in Virtual Surround mode it is possible to achieve surround effects even without the presence of physical rear loudspeakers.

The mode of operation can be changed by the **MODE** button. The first press on the **MODE** button displays the currently selected mode of operation on the front display. Further button-presses toggle between the modes of operation.

Status indicator

The CALA CDR has a status indicator to the left of the display field to indicate stand-by mode and the alarm function. When the energy saving function is deactivated (see chapter "**Basic settings of Cala CDR**"), the red glowing status indicator informs that standby mode is active.

If the status indicator glows green, an alarm time is programmed in the alarm menu.



The status indicator is available for devices with serial number 2927 3234 00802 and higher.

Basic settings of the CALA CDR

(System Configuration menu)

The System Configuration menu is used for adjusting the general settings of the machine. This menu is described in detail in the following chapter.

Calling up and operating the menu

- To call up the menu press the **sys** button briefly on the remote control handset.
- When the menu is opened, the screen displays the following Select points:

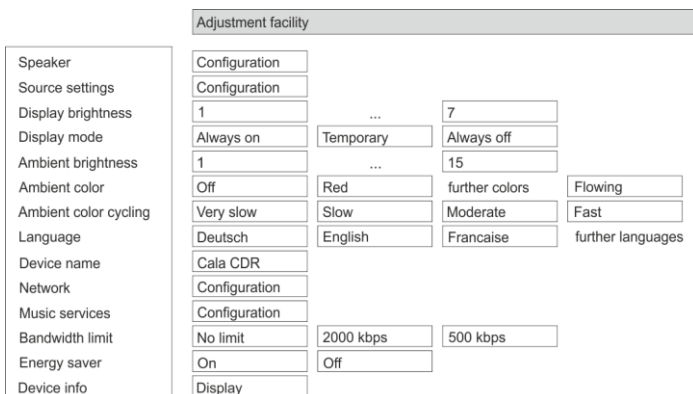

- Use the **▲** / **▼** buttons to select a point in the menu.
- If you wish to change the selected menu point, first press the **OK** button, then use the **◀** / **▶** buttons to alter the value.
- To accept the setting once you have changed the value, press the **OK** button again.
- If you wish to quit without accepting any alteration, press the **■** button at any time.
- Press the **sys** button again to leave the menu.

Menu item

Speaker

Speaker setup and room acoustics

This menu point opens a sub-menu in which the settings for the loudspeakers can be altered.

Sub-point

Speaker LF Shape

In this menu point you can set the loudspeaker type and, if appropriate, the cross-over frequency between the main loudspeakers (loudspeaker group A - left / right) and the sub-woofer.

If you are using large loudspeakers, please choose the "FULL RANGE" setting. For relatively small satellite speakers we suggest that you choose a cross-over frequency of 40Hz, 60Hz, 100Hz or 150Hz, depending on the size and bass performance of your loudspeakers.

Sub-point
SPK stand ...

This is the basic rule: the smaller the speaker cabinet, the higher the cross-over frequency should be. The "Bass extd." setting is recommended for small loudspeakers such as small bookshelf units, if they are operated without a sub-woofer. At this setting the bass range of the speaker is extended to low frequencies.

If loudspeakers are set up close to a wall or a corner, the result may be a disproportionate boost to the low frequencies. To compensate for this effect please select one of the set-up options free / near to wall / in a corner / shelf, according to the location of your loudspeakers.

Sub-point
Room

The purpose of this menu is to fine-tune the **CALA CDR** to match the acoustics of your listening room. For highly damped rooms it is advisable to select one of the "absorptive" settings 1 - 4.

The "reflective" settings 1 - 6 help to reduce any reverberant effects.

If your listening room is normally damped, this setting should be left at "normal".

Sub-point
Subwoofer

In this menu point you can set the cross-over frequency for your sub-woofer. If your system does not include a sub-woofer, you should choose the "OFF" setting.

Sub-point
OUT / Phones

In this menu point you can disable the room correction settings for the use of headphones. Choose the setting "phones" to bypass the room correction and choose the setting "OUT" if e.g. active speakers are connected, for which the room correction is eventually required.

 Is the setting „**phones**“ selected, the settings for the menu items „**Room**“ (System settings menu) and „**Contour presence**“ and „**Contour fundamental tone**“ (Tone menu) have no effect to the phones- and Analog OUT sockets.

Menu item
Source settings

This menu point opens a sub-menu in which the individual sources connected to the **CALA CDR** can be configured.

 **Not all the set-up options are available for all sources.**

Sub-point
Available



The purpose of this menu point is to disable / activate the corresponding source.



 Disabled sources do not appear in Source Select when you operate the remote control handset, and this makes it easier to select the correct source. It is therefore advisable to disable all sources which you do not use.

Sub-point
Source name

At this menu item you can assign a plain text name to each source; this name then appears in the screen displays.

When you call up this menu item using the  button, a list of all the internal and external sources of the **CALA CDR** appears.

To change the plain-text name, move to the appropriate line and press the  button. Now use the alpha-numeric keypad of the **SRC1** to change the name as required, then confirm your choice with ; this saves the settings for that source.

The  button is used to switch between numeric and alpha-numeric input, and between capitals and lower-case letters. Letters can be erased by pressing the  button.

If you should wish to restore the factory default source name, erase the whole name before saving the empty field with the  button: this action resets the display to the standard source names.

Sub-point
Auto-power-on

This menu point enables you to automatically switch on the **CALACDR** due to the automatic power-on function.

If this function is switched on, the **CALACDR** automatically switches itself on from standby mode, and switches to the selected source (if necessary), when a music signal is present at the **Analog In 1**, **Analog In 2** or **Digital In 1 - 3** input - depending on the input to which the auto power-on function is assigned.

If the **CALACDR** is switched on, but no signal is detected at the auto power-on input within about twenty minutes, then the **CALACDR** automatically switches itself off again; however this only occurs if the auto power-on source is selected.



The automatic power-on function is only active when the Energy Saver function is disabled.

Sub-point
Passthrough

If you wish to connect a device with its own volume control (e.g. TV set), this menu point can be used to disable the volume control of the **CALACDR** for the **Analog In 1** input (pass-through mode).



You should only select this setting if a device with its own volume control is connected to the unit. Ensure that the volume of the source device is turned down to zero before connecting it to the **CALACDR**, otherwise the speakers connected to it may be ruined through overloading.

Sub-point
Phono mode

The purpose of this menu point is to configure the input **Analog In 2** for connecting a turntable fitted with an MM pick-up.



Never select this setting unless a turntable (without integrated phono preamp – output voltage until 10 mV) is connected to the **CALACDR**, otherwise the speakers connected to the unit may be ruined through overloading.

Sub-point
Input level

The input for sources **Analog In 1** and **Analog In 2** can be adjusted to suit the output level of the device connected to these sockets. The input level can be set to any of four values. Set the input in such a way that the volume matches that of the **CALA CDR**'s internal sources, then confirm your choice with the **OK** button. This action saves the settings for that source. The input level can be adjusted to any of the settings 500 mV, 1,0 V, 2,0 V or 2,8 V.

- i** If you have configured the source **Analog In 2** for connecting a turntable, this set-up option is used to adjust the input sensitivity to any of the settings 2.5mV, 5mV or 10 mV to suit an MM pick-up.

Menu item
**Display
brightness**

Here you can adjust the brightness of the screen in normal use to suit your personal preference. The available settings are:
1 to 7

- i** We recommend that brightness settings 6 and 7 should only be used when the screen is difficult to read due to very bright ambient light. A lower brightness setting will extend the useful life of the screen.

Menu item
Display mode

This menu item offers the choice between three different display operation modes:

- Always on
- Temporary
- Always off

Selecting 'Temporary' will switch the display is on for a short while each time the **CALA CDR** is being operated. Shortly after operation the display will be switched off again automatically.

- i** To switch the display on again, from the "always off" setting, call up the system settings menu by a brief press on the **sys** button.

Menu item
**Ambient
brightness**

In this menu point you can set your preferred brightness for the ambient lighting of the **CALA CDR**. The brightness can be adjusted to any of ten settings.











Menu item
**Ambient
colour**

In this menu point you can switch on and set the preferred colour for the ambient lighting.

Menu item
**Ambient
colour cycling**

If you have configured the ambient colour (see menu item above) to the setting "flowing", under this menu item you can adjust the speed the ambient lighting cycles through the different colours in four steps from very slow to fast.

- i** This menu item only appears, if under the menu item "**Ambient colour**" the setting "**flowing**" is selected.

<p>Menu item Language</p>	<p>In this menu point it is possible to determine the language which is to be used for the displays on the integral screen on the front panel of the CALA CDR.</p> <p> The language used for any transferred data, e.g. from an Internet radio station, is determined by the device itself or the radio station, and therefore cannot be selected on the CALA CDR.</p>
<p>Menu item Device name</p>	<p>This menu point can be used to assign an individual name to the CALA CDR. In a home network the device then appears under this name.</p>
<p>Menu item Network</p>	<p>All network settings can be carried out at this menu point. For a detailed description on setting up a LAN or WLAN connection please also refer to the section entitled "Network configuration".</p>
<p>Menu item Music services</p>	<p>At this point you can enter the access data for the music streaming services (TIDAL etc.) supported by the CALA CDR. Calling up this menu point by pressing the  button displays a list of the supported music services. Select the service you wish to use, then confirm your choice with the  button.</p> <p>Now use the alpha-numeric keypad of the SRC1 to enter the access data which you have received from your service provider in the lines "User" and "Passphrase". Use the  button to switch between numeric and alpha-numeric input, and between capitals and lower-case letters. Press the  button to erase any letter. In each case confirm your input of user name and password by pressing the  button.</p> <p>To conclude the procedure and save the data, select the menu entry "Store and exit?" and confirm by pressing the  button.</p> <p> If access data for the selected music service has already been stored, the new data will overwrite them. To use the new access data you must first perform a "Logout" for the service in question, then switch the CALA CDR off and on again.</p> <p> The music streaming services supported by the CALA CDR require a subscription to the appropriate service provider.</p>
<p>Menu item Bandwidth limit</p>	<p>This menu point can be used to adjust the link speed of the Internet connection. The bitrate of the Internet radio stations and streaming services is adjusted automatically to match your chosen setting. If you select "no limit" for bandwidth limit, the highest available quality is always selected automatically.</p> <p> If you do not know the exact bandwidth of the internet connection, we recommend that you select the setting at which no drop-outs occur during playback.</p>

Menu item
Energy saver
(Stand-by
mode)

The **CALA CDR** features two stand-by modes: ECO Standby with reduced stand-by current drain, and Comfort Standby with additional functions, but slightly higher current drain. You can select your preferred stand-by mode in this menu point:

On (ECO Standby)

Active functions in ECO Standby mode:

- Alarm-timer with clock display
- Can be switched on by remote control

Off (Comfort-Standby)

The following expanded functions are available:

- Alarm-timer with clock display
- Can be switched on by remote control
- Can be switched on by App
- Automatic power on function for inputs **Analog In 1**, **Analog In 2** and **Digital In 1 -3**.

Device Info
menu item

At this menu point you will find information on the status of the installed software and the factory reset.

Sub-point
Update

At this point it is possible to initiate a firmware update. The update can be accessed from an Internet connection.

Sub-point
**Update
package**

This point displays the currently installed software package.

Sub-point
Control

Display of the control software version

Sub-point
Client

Display of the Streaming Client software version

Sub-point
DAB / FM

Display of the tuner software version.

Sub-point
Decoder

Display of the CD mechanism decoder software

Sub-point
**Default
settings**

Calling up and confirming this menu point erases all personal settings, and restores the machine to the state as delivered (factory defaults).

Sub-point
**Legal
information**

Calling up and confirming this menu point erases all personal settings, and restores the machine to the state as delivered (factory defaults).



For further information, see the chapter entitled "**Legal Information**".

Alarm Timer

The machine features an integral Timer module which is capable of switching the **CALACDR** on with a selectable source at a programmable time (alarm clock).

Selecting an alarm timer in the Alarm Timer menu switches the function on and activates it. You can now switch the **CALACDR** off. The **CALACDR** will switch itself on at the pre-set time for as long as the set time is displayed on the screen.

 This function is only possible if the Energy Saver is switched off. Please refer chapter "**Basic settings of the CALACDR**".

Alarm function - with automatic power-off



If the Timer is active, the **CALACDR** switches itself on at the programmed alarm time. Once switched on, a bell symbol flashes on the screen.

The **CALACDR** switches itself off automatically one hour after the alarm time, unless the alarm function is disabled during this period.

The alarm function can be disabled by operating or switching off the device. If the alarm function is disabled, the time display and bell disappears. If the timer is disabled by operating the device it now does **not** switch itself off **automatically** after an hour! If you wish to switch the machine off, you must do so manually by pressing the  button.





Switching the Timer off

A long press on the  button calls up the Alarm Timer menu, where the timer can then be disabled.

 A long press on the  button calls up the Alarm Timer menu even when the machine is switched off.

Quick selection menu

An alarm timer set in the alarm timer menu can be selected comfortably, quick and without switching on the device, by using the quick selection menu.

A brief press on the  button calls up the quick selection menu. Further button presses, repeatedly if necessary, select the desired alarm timer. The alarm time of the selected timer can be adjusted by pressing the  /  buttons and the volume can be set by pressing the  + buttons.

A brief press on the  button enables the selected alarm timer.

Alarm Timer menu

Calling up and operating the menu

- A long press on the **sys** button calls up the menu.
- When you open the menu, you will hear the currently set alarm source at the currently set alarm volume.
- The screen displays the following Select points:

Adjustment facility			
Alarm	Alarm Time 1	Alarm Time 2	Alarm Time 3
Alarm Time	00:00	...	23:59
Alarm Source	Tone	FM-Radio: WDR 2	DAB-Radio: DKultur
Alarm Vol.	10	...	85
Time Mode	Summer time	Winter time	FM
Set Time	00:00	...	23:59
Time display	AM / PM	24h	
Show clock	Yes	No	
Brightn. Clk	1	...	3

- Use the / to select a point in the menu.
- If you wish to change a selected menu point, first press the **OK** button, and then use the / buttons to alter the value.
- To accept the setting once you have altered the value, press the **OK** button again.
- If you wish to quit **without** accepting an alteration you have made, press the button at any time.
- Press the **sys** button again to leave the menu.

Menu item Alarm

In this menu point you can select whether the machine is to be switched on automatically, and using which alarm.

Menu item Alarm Time

Manual alarm time setting for the currently active alarm. Any change you make at this point takes place slowly at first; holding the button pressed in increases the rate of change.

Menu item Alarm Source

Selects the source which is to be switched on at the alarm time point.

If you select the menu point Radio, you can use the / buttons to select a radio station from the Favourites list.



Waking to the radio:

Take care to set a station which can be received well.

Menu item Alarm Vol.

You can set the alarm volume at this point. If you change the volume setting, the system immediately accepts the displayed volume level, and the change in volume is audible.

Menu item Time Mode

This menu point is used to determine how the internal clock is set.

FM / DAB: If you select the menu point **FM** or **DAB**, you can select a radio station from the Favourites list using the / buttons.

If a station is selected, the time of day is automatically read out from the RDS signal at night. If the selected station is the current listening source, then the time of day is also taken from the machine when it is switched on. This only works if a good RDS signal can be received.

It is not possible to adjust the time of day manually!

Summer time: The time of day can be set manually in the menu point 'Set time'.

Winter time: The time of day can be set manually in the menu point 'Set time'.

Menu item
Set Time

Manual method of setting the internal clock to the correct time. Any change you make at this point occurs slowly at first - holding the button pressed in increases the rate of change.



Manual adjustment is only possible if you have set Summer or Winter in the menu point 'Clock mode'.

Menu item
Time display

At this point the time format can be set to 12 hour (AM / PM) or 24 hour format.

Menu item
Show clock

At this point you can choose whether the time of day is displayed in standby operation.

Menu item
**Brightness
Clock**

At this point you can adjust the screen brightness in Stand-by mode to suit your personal preference. The brightness setting becomes active immediately.



This menu item appears only if the clock is displayed in standby operation. See menu item above.



Slumber-function

The machine has a slumber function that switches it to standby after a selectable time interval between 15 minutes and 12 hours. This selection can be done in steps of 15 minutes.

**Activate
slumber
function**

While the **CALA CDR** is powered up keep the  key of the remote control pressed until the display shows the slumber time.

**Change the
slumber time**

While the slumber function is active the slumber time can be modified in steps of 15 minutes using the  / -keys. Any change comes immediately into effect.

**Turn off
slumber
function**

While the slumber function is active it can be turned off by keeping the  key pressed until the displaying of the slumber time is not shown any longer on the display. After switching the function off the device can be operated in the usual way. Alternatively the slumber function is also ended when the **CALA CDR** is switched off.



As long as the slumber function is active there is no other user operation possible besides the slumber functions mentioned above and the changing of the volume.

Operating the sources in detail

Favourites lists

General information

The CALA CDR includes the facility to create Favourites lists. The purpose of these lists is to store radio stations and podcasts, so that they can be accessed swiftly.

Each of the sources **FM radio**, **DAB radio**, and **Internet radio** features its own Favourites list.

Once stored, the favourites can either be selected from the Favourites list, or called up directly by entering the program location number. The option of selecting using the location number is particularly useful when you wish to call up favourites when the screen is not in view (e.g. from an adjacent room) or using a house control system.

- i** Favourites lists for the various music services (TIDAL etc.) are not supported. Instead it is usually possible to add Favourites and Playlists on-line via the provider's account. These can then be called up and played via the CALA CDR

Calling up the Favourites list

- The first step is to switch to one of the sources listed above.
- Press the  button to call up the Favourites list.

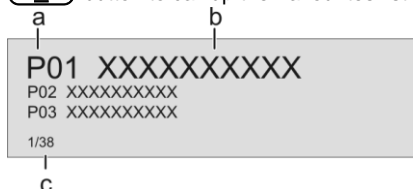





- a) Here the program location number is displayed within the list. Since it is possible to erase individual list items, the numbering may not be continuous.
- b) The selected list entry is displayed in enlarged form.
- c) Position display in the Favourites list.

Adding a favourite

If you especially enjoy the piece of music or radio station to which you are currently listening, simply press the green  button on the **SRC1**; this action stores the station in the corresponding Favourites list.







- i** Each Favourites lists features 99 program locations. Favourites lists can only be used to store the piece of music and station which is currently playing.

Erasing a favourite from the Favourites list

Open the Favourites list by pressing the  button. Use the  /  buttons to select the station in the list which you wish to erase, then hold the red  button pressed in; this action removes the item from the Favourites list.



 Erasing a Favourite does not cause the following Favourites to move up the list. The station position is no longer displayed after erasure, but a new Favourite can still be assigned to it.

Selecting a favourite from the list

- Press the  button to call up the Favourites list.
- Use the  /  buttons to select a stored item from the Favourites list. The selected favourite is displayed in enlarged form.
- Select the favourite to be played by pressing the  or  button.
- You can return to the station to which you are currently listening (quit) by pressing the  button.

Directly selecting a favourite





In addition to the option of selecting favourites using the Favourites list, it is possible to access the desired favourite directly by entering the program location number.

To select a stored favourite directly during playback, enter the two-digit program location number of the new favourite using the numeric buttons ( to ) on the remote control handset.

After you have pressed the numeric buttons, playback switches to the favourite you have just selected.

Sorting Favourites lists

The sequence of items in the Favourites list you have created can be altered in any way you wish. This is the procedure for changing the order of the list:

- The first step is to call up the Favourites list by briefly pressing the  button.
- Use the  /  buttons to select the favourite whose position you wish to change. The selected Favourite is displayed in enlarged form.
- Pressing the  button activates the Sort function for the selected favourite. The favourite is highlighted on the screen.

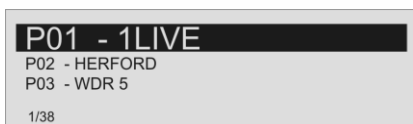

- Now move the activated favourite to your preferred position in the Favourites list.
- A further press on the  button de-activates the Sort function, and the favourite is stored at the new position.

Briefly press the  button again to close the Favourites list.

 If you have previously erased a number of favourites, you may well find that some program locations in the Favourites list are missing (empty). Nevertheless, the favourites can still be moved to any location in the list!

Operating the radio

The CALA CDR features an **FM tuner** (VHF radio), a **DAB / DAB+** receiving section (digital radio) and also includes the facility to stream **Internet radio**. The following section describes in detail how to operate the individual radio sources.

FM - Radio

Selecting FM radio

Briefly tap the **RADIO** button on the **SRC1** remote control handset, repeatedly if necessary, until the source "**FM Radio**" is displayed on the screen.

General

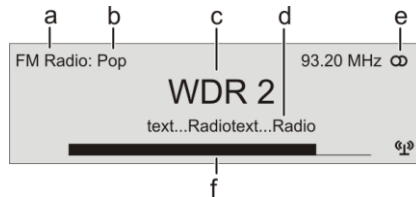

- Displays the type of reception currently in use.
- Hear the music type or style is displayed, e.g. Pop Music.
- This information is only displayed if the transmitting station broadcasts it as part of the *RDS* system. If you are listening to a station which does not support the *RDS* system, or only supports it in part, these information fields remain empty.
- The frequency and / or the station name is displayed in enlarged form. If a station name is displayed, its frequency is shown in area 'e'.
- These lines display information which is broadcast by the station (e.g. Radio text).
- Display of Stereo '🔊' / Mono "●"

The *field strength* 📶 and therefore the reception quality to be expected from the set transmitting station can be assessed from the field strength.

Manual station search

Holding one of the **◀◀** / **▶▶** buttons pressed in initiates a station search for FM tuner in the upward or downward direction. The station search stops automatically at the next station. A frequency can be selected directly by pressing the **◀◀** / **▶▶** buttons repeatedly. Briefly pressing the **◀◀** / **▶▶** buttons on the **SRC1**, repeatedly if necessary, enables you to select a particular frequency.

As soon as the station is audible, you can add it to your Favourites list by pressing the **📌** button.

Automatic station search

A brief press on the **SRC** button calls up the Station list menu. The following Select points are available:

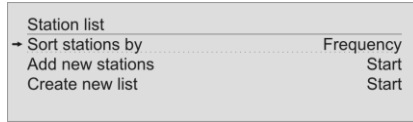

- If you wish to create a new station list, select the item **“Create new list”** and confirm your choice with **OK**.
- The station search begins, and automatically searches for all radio stations which the machine is able to pick up.
- If you wish to update an existing list, select the item **“Add new stations”**.
- The menu item **“Sort stations by ...”** allows you to sort the stored list by any of several criteria.

Selecting a station from the Station list

- Pressing the **▲** / **▼** buttons opens the list of all stored stations.

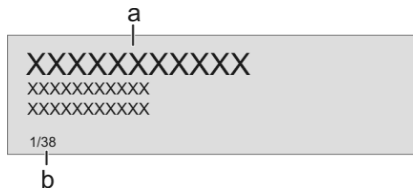

- Use the **▲** / **▼** buttons to select one of the stored stations. The station you choose is now displayed in enlarged form. Press the **▶** or **OK** button to select the enlarged station for playing. Pressing the **◀** button returns you to the station to which you are currently listening (quit).
- Position indicator in the Favourites list.

i Stations to which you often listen can be stored in a Favourites list; this makes it easier to select them (see the section entitled **“Favourites list”**).

RDS functions

i If the station being received is broadcasting relevant RDS data, the following information will be displayed on the screen:

- **Station name**
- **Radio text**
- **Program type (genre)**

For stations that do not support the RDS system or only partially or with weak reception, no information will be displayed.

Switching Radio Text on and off

The Radio text function can be switched on and off by briefly pressing the  button on the remote control handset.

Mono / Stereo (only FM – Radio)

You can toggle the radio of the **CALACDR** between stereo and mono reception by briefly pressing the  button. The reception mode is shown on the screen by the following symbols:

● (Mono) or '⊕' (Stereo)

If the station you wish to listen to is very weak or very distant, and can only be picked up with severe background noise, you should always switch to MONO mode as this reduces the unwanted hiss significantly.

 The Mono and Stereo symbols are only shown in the detailed screen display.

DAB - Radio

Selecting DAB radio

Briefly tap the  button on the **SRC1** remote control handset, repeatedly if necessary, until the source “**DAB Radio**” is displayed on the screen.

 Depending on the frequency band (block), it may take up to two seconds to switch stations when in **DAB mode**.

Display

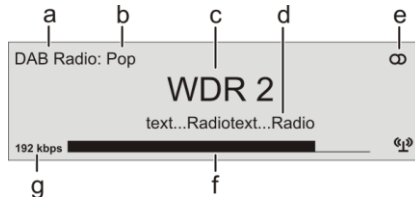

- a) Displays the type of reception currently in use.
- b) Hear the music type or style is displayed, e.g. Pop Music.
This information is only displayed if the transmitting station broadcasts it as part of the *RDS* system. If you are listening to a station which does not support the *RDS* system, or only supports it in part, these information fields remain empty.
- c) The frequency and / or the station name is displayed in enlarged form. If a station name is displayed, its frequency is shown in area 'e'.

- d) These lines display information which is broadcast by the station (e.g. Radio text).
 - e) Display of Stereo 'Ⓢ'.
 - f) The *field strength* (q) and therefore the reception quality to be expected from the set transmitting station can be assessed from the field strength.
 - g) Bit-rate of the broadcasting station when listening to DAB radio.
- * The higher the bit-rate, the better the station's sound quality.

Automatic station search

A brief press on the **SRC** button calls up the Station list menu. The following Select points are available:

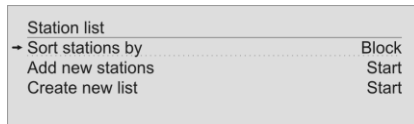

- If you wish to create a new station list, select the item **“Create new list”** and confirm your choice with **OK**.
- The station search begins, and automatically searches for all radio stations which the machine is able to pick up.
- If you wish to update an existing list, select the item **“Add new stations”**.
- The menu item **“Sort stations by ...”** allows you to sort the stored list by any of several criteria.

Selecting a station from the Station list

- Pressing the **▲** / **▼** buttons opens the list of all stored stations.

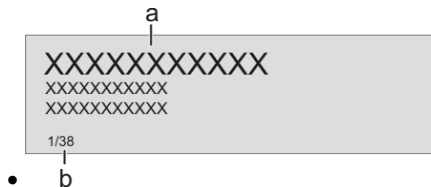

- a) Use the **▲** / **▼** buttons to select one of the stored stations. The station you choose is now displayed in enlarged form. Press the **▶** or **OK** button to select the enlarged station for playing. Pressing the **◀** button returns you to the station to which you are currently listening (quit).
- b) Position indicator in the Favourites list.

i Stations to which you often listen can be stored in a Favourites list; this makes it easier to select them (see the section entitled **“Favourites list”**).

RDS functions

If the station being received is broadcasting relevant RDS data, the following information will be displayed on the screen:

- **Station name**
- **Radio text**
- **Program type (genre)**

For stations that do not support the RDS system or only partially or with weak reception, no information will be displayed.



Since firmware version V1.11 the device supports DAB+ reception via the Swiss cable TV network. For further information about updating the firmware, please refer chapter „Software update“.

Internet-Radio

Selecting Internet Radio as source

Briefly tap the **RADIO** button on the **SRC1** remote control handset, repeatedly if necessary, until the source **Internet Radio** is displayed on the screen.

Selecting podcasts

Select the **Podcasts** entry instead of the **Internet Radio** entry. The source **Podcasts** is operated in the same way as the **Internet Radio** source.





The method of operating music services is described separately in the section entitled **Operating music services**.

Playback

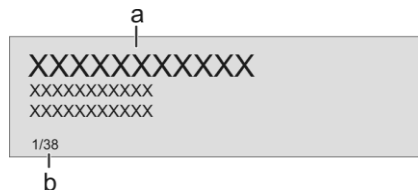

The music content to be played is selected with the help of Select lists. These lists are controlled using the navigation buttons (cursor buttons) on the remote control handset.



- a) Use the  /  buttons to select the desired entry from the list.

A brief press selects the previous / next entry within the list. The scrolling speed can be increased by holding the button pressed.

The list entry you choose is now displayed in enlarged form.

Press the  or  button to open or start the list entry shown in enlarged form.

Pressing the  button returns you to the previous folder level.

- b) Indicates the currently selected point within the opened list.

Starting playback

Press the  button on the remote control handset or the machine's front panel to start playback.

Stopping playback

Pressing the  button halts playback.







Favourites lists

Stations and podcasts to which you often listen can be stored in a Favourites list; this makes it easier to select them (see the section entitled "**Favourites list**").

Search function

The Search function provides a means of locating Internet radio stations swiftly.

This is the procedure for searching for a particular Internet radio station:

- Locate the Select list for the entry "**Radio**", then use the  /  buttons to select the "**Search**" item, and confirm your choice by pressing the  button or while navigating within lists alternatively call up the search function by pressing the blue  button.
- You will now see a window in which you can enter the keyword using the remote control handset's alpha-numeric keypad.
- Press the  button to erase any letter.
- Briefly press the  button to start the search.
- After a short delay you will see a list of the search results.



The search function can be called up from every point within the lists by pressing the blue  button.

The search strings can consist of up to eight characters. It is also possible to enter multiple keywords separated by a space character, e.g. "BBC Rad".

To search for a podcast, select the "**Search**" entry under "**Podcasts**".

Operating music services

General information

The *Calá* supports playback of music services such as TIDAL. To make use of music services you may need to take out a paid subscription with the appropriate provider.

Use of music services requires the input of access data (username and password). These access data can be stored separately for each provider in the "Music services" menu within the System Configuration menu (see the section entitled "**Basic settings of the CALA CDR**").

-  Future music services and others which are not currently supported may be added subsequently by updates to the firmware of the **CALA CDR**.





Selecting the music service

Press the **(SCL/USB)** button on the **SRC1**, repeatedly if necessary, to select a streaming service as source.

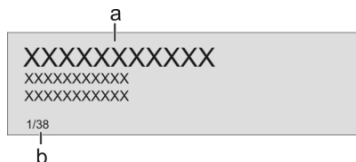
Playback

The music content to be played is selected with the help of Select lists. These lists are controlled using the navigation buttons (cursor buttons) on the remote control handset.



- a) Use the  /  buttons to select the desired entry from the list.
A brief press selects the previous / next entry within the list. The scrolling speed can be increased by holding the button pressed.
The list entry you choose is now displayed in enlarged form.
Press the  or  button to open or start the list entry shown in enlarged form.
Pressing the  button returns you to the previous folder level.
- b) Indicates the currently selected point within the opened list.



Starting playback

Press the  button on the remote control handset to start playback.

Stopping playback

Pressing the  button halts playback.



Skipping tracks

A brief press on the  /  buttons during playback causes the device to jump to the next or previous piece of music within the current playlist.

 The exact form of the displayed list and the preparation of the content depend to a large extent on the music service provider. You may therefore find that in some cases not all the functions described in these instructions can be used.

Search function

In order to find quickly what you want in the wide range of services on offer, it is possible to search for specific items in the content available from music service providers.

The first step in the procedure is to open the Select list of the appropriate music service. Navigate to the “**Search**” entry, and confirm by pressing the  button. As an alternative it is possible to call up the search function by pressing the blue  button while navigating in lists.



A window now opens in which the keyword can be entered using the remote control handset’s alpha-numeric keypad.

Press the  button to erase any letter.

Start the search by briefly pressing the  button.

After a short delay a list appears showing the search results.

The results list varies from one music service to another. Many services allow you to filter the search results by artiste, album or track once the search has been completed.

 The search function can be called up from every point within the lists by pressing the blue  button.

 The search strings can consist of up to eight characters. It is also possible to enter multiple keywords separated by a space character, e.g. “The Beat”.

Playlists and favourites

Most music services offer the facility to register on the provider’s website with the user data, create dedicated playlists, and manage the lists conveniently.

Once created, the playlists appear in the Select list of the corresponding music service, where they can be called up and played via the *Code*.

The location within the select list at which the playlists can be accessed varies from one music service to another. Often these folders are named “My music”, “Library”, “Favourites” or similar.

Operating the UPnP / DLNA source

(Streaming Client)

General information on the streaming client

The CALA CDR features what is known as a 'streaming client'. This facility makes it possible to play music files stored on PCs or servers (NAS) within the network.

The media content formats which the CALA CDR can reproduce are very wide-ranging, and extend from compressed formats such as MP3, AAC and OGG Vorbis to high-quality non-compressed data formats such as FLAC, ALAC, AIFF and WAV, which are thoroughly audiophile in nature. A full listing of all possible data and playlist formats is included in the Specification, which you will find in the Appendix to these instructions.

Since virtually no read or data errors occur when electronic memory media are accessed, the potential reproduction quality is even higher than that of CD. The quality level may even exceed that of SACD and DVD-Audio.

Selecting the UPnP/DLNA source

Briefly tap the **(eCL/USB)** button on the SRC1 remote control handset, repeatedly if necessary, until the source "UPnP/DLNA" is displayed on the screen.

Playback

The music content to be played is selected with the help of Select lists. These lists are controlled using the navigation buttons (cursor buttons) on the remote control handset.

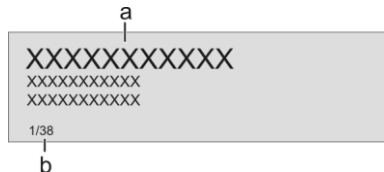

- a) Use the **(▲)** / **(▼)** buttons to select the desired entry **Server / Folder / Track** from the list.

A brief press selects the previous / next entry within the list. The scrolling speed can be increased by holding the button pressed.

The list entry you choose is now displayed in enlarged form.

Press the **(▶)** or **(OK)** button to open or start the list entry shown in enlarged form.

Pressing the **(◀)** button returns you to the previous folder level.

- b) Indicates the currently selected point within the opened list.

(i) The exact form of the displayed list and the preparation of the content also depend to a large extent on the capabilities of the server, i.e. the full facilities of the CALA CDR cannot be exploited with all servers or media. You may therefore find that in many cases not all the functions described in these instructions can be used.



Starting playback

Press on the  button to start playback.

Stopping playback

Pressing the  button halts playback.

Skipping tracks

A brief press on the  /  buttons during playback causes the device to jump to the next or previous piece of music within the current playlist.

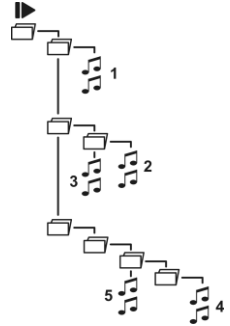

Playback of directories

In addition to the facility to play back individual folder content, it is also possible to play back entire directories. This is accomplished by selecting the folder of the directory to be played, then pressing the  button to start playback. Playback commences with the first entry in the list of content to be played. If an entry in the list should contain a folder with additional sub-folders, the content of the lowest folder is always played first. This is followed by the content of the next higher folder level, etc. (see diagram right).



Search function

In order to find quickly what you want in the wide range of services on offer, it is possible to search for specific items in the content available from music service providers.

The first step in the procedure is to open the Select list of the appropriate music service. Navigate to the “**Search**” entry, and confirm by pressing the  button. As an alternative it is possible to call up the search function by pressing the blue  button while navigating in lists.



A window now opens in which the keyword can be entered using the remote control handset’s alpha-numeric keypad.

Press the  button to erase any letter.

Start the search by briefly pressing the  button.

After a short delay a list appears showing the search results.

The results list varies from one music service to another. Many services allow you to filter the search results by artiste, album or track once the search has been completed.

 If the text searched for is not found the best matching result will be shown. You can abort the search using the -button.

 The function searches only the current folder. Eventually existing subfolders are ignored.

Playing USB memory media (USB Media source)

General information

The CALA CDR is capable of playing music files stored on USB memory media, and features two USB sockets for this purpose: **USB 1** and **USB 2** on the back panel.

-  The memory medium can be formatted with any of the following file systems:
FAT16, FAT32, NTFS, ext2, ext3 or ext4.
It is also possible to power the USB memory medium via the USB socket, provided that the unit's current drain accords with the USB norm. Normed 2.5 inch USB hard discs can be connected to the socket directly, without requiring their own mains PSU.





Selecting USB Media as source

Press once or twice on the  button in order to select "**USB MEDIA**" as source.
All USB memory media connected to the machine are now displayed. If no USB memory medium is found, the screen displays the message "**No USB media available**".

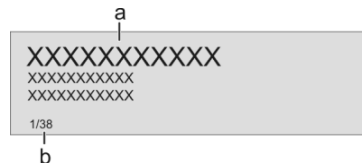
Playback

The music content to be played is selected with the help of Select lists. These lists are controlled using the navigation buttons (cursor buttons) on the remote control handset.



- a) Use the  /  buttons to select an (a) **USB memory / folder / track** from the list.
A brief press selects the previous / next entry within the list. The scrolling speed can be increased by holding the button pressed.
The list entry you choose is now displayed in enlarged form.
Press the  or  button to open or start the list entry shown in enlarged form.
Pressing the  button returns you to the previous folder level.
- c) Indicates the currently selected point within the opened list.



Starting playback

Press on the  button to start playback.

Stopping playback

Pressing the  button halts playback.

Skipping tracks

A brief press on the  /  buttons during playback causes the device to jump to the next or previous piece of music within the current playlist.

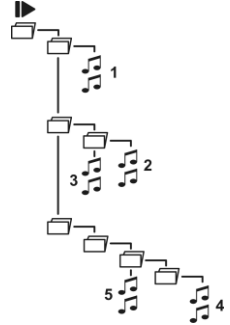

Playback of directories

In addition to the facility to play back individual folder content, it is also possible to play back entire directories. This is accomplished by selecting the folder of the directory to be played, then pressing the  button to start playback. Playback commences with the first entry in the list of content to be played. If an entry in the list should contain a folder with additional sub-folders, the content of the lowest folder is always played first. This is followed by the content of the next higher folder level, etc. (see diagram right).





Search function

In order to find quickly what you want in the wide range of services on offer, it is possible to search for specific items in the content available from music service providers.

The first step in the procedure is to open the Select list of the appropriate music service. Navigate to the “**Search**” entry, and confirm by pressing the  button. As an alternative it is possible to call up the search function by pressing the blue  button while navigating in lists.



A window now opens in which the keyword can be entered using the remote control handset’s alpha-numeric keypad.

Press the  button to erase any letter.

Start the search by briefly pressing the  button.

After a short delay a list appears showing the search results.

The results list varies from one music service to another. Many services allow you to filter the search results by artiste, album or track once the search has been completed.

 If the text searched for is not found the best matching result will be shown. You can abort the search using the -button.

 The function searches only the current folder. Eventually existing subfolders are ignored.

Operating the Bluetooth Receiver

The **CALACDR**'s integral Bluetooth interface provides a means of transferring music wirelessly from devices such as smart-phones, tablet PCs, iPods, etc. to the *Cala*.

- For a successful audio Bluetooth transfer from a mobile device to the **CALACDR** the mobile device must support the A2DP Bluetooth audio transfer protocol.

Selecting Bluetooth

Select **Bluetooth** as source by pressing the  - button on the remote control handset.
The machine's integral screen now displays **Bluetooth** as source.

Setting up audio transfer

Before music from a Bluetooth-capable device can be played through the **CALACDR**, the external device must first be registered to the **CALACDR**. As long as the **CALACDR** is switched on and no device is connected, it is always ready to receive. In this state the screen displays the message 'not connected'.

This is the procedure for establishing a connection:

- Start a search for Bluetooth equipment on your mobile device.
- When it finds the **CALACDR**, make the connection to your mobile device.

Once the connection is successfully established, the message on the **CALACDR**'s screen switches to 'connected to *YOUR DEVICE*'.

- If your device requests a PIN code, this is always '0000'.

- Due to the large number of different equipment on the market, we are only able to provide a general description for setting up the radio connection. For detailed information please refer to the operating instructions supplied with your device.

Playback functions

Information on the piece of music being played is displayed on the integral screen of the connected mobile device. If possible we recommend that you leave the screen backlight switched on permanently to ensure that it is clearly legible.

Some Bluetooth devices which support the AVRCP protocol can be controlled by **CALACDR**'s SRC1 remote control handset.

The behaviour and method of operating the connected mobile device are determined by the device itself. In general terms the function of the buttons the SRC1 remote control handset are as follows:

Start and pause playback



The  button is used to start and pause playback (PLAY / PAUSE function).

Stop playback





Pressing the  button halts playback.

Switch track



/



A brief press on the  /  buttons during playback causes the device to jump to the next or previous piece of music within the current playlist.



Please note that many AVRCP-capable mobile devices do not support the controlling through the **CALACDR**. In case of doubt, please ask the manufacturer of your mobile device.

Volume adjustment

To achieve the best possible playback quality, you should only adjust the volume on the **CALACDR** itself: set the playback volume as high as possible on your mobile device, but not so high that the signal is distorted.

Any further changes to volume should then be made using the



button on the **SRC1**.

Notes



The **CALACDR** has been tested with a large number of Bluetooth-capable mobile devices. However, we are unable to guarantee general compatibility with all devices available commercially since the range of equipment is so wide, and the various implementations of the Bluetooth standard differ widely in some cases. If you encounter a problem with Bluetooth transfer, please contact the manufacturer of the mobile device.

The maximum range of a Bluetooth audio transfer is normally about 3 to 5 metres, but the effective range may be affected by a number of factors. To achieve good range and interference-free reception there should be no obstacles or persons between the **CALACDR** and the mobile device.

Bluetooth audio transfers take place in what is known as the “everyman frequency band”, in which many different radio transmitters operate - including WLAN, garage door openers, baby intercoms, weather stations, etc. Radio interference caused by these other services may cause brief dropouts or - in rare cases - even failure of the connection, and such problems cannot be excluded. If problems of this kind occur frequently in your environment, we recommend that you use the Streaming Client or the USB input of the **CALACDR** instead of Bluetooth.

By their nature, Bluetooth transmissions always involve data reduction, and the attainable sound quality varies according to the mobile device in use, and the format of the music to be played. As a basic rule the maximum quality of music which is already stored in a data-reduced format, such as MP3, AAC, WMA or OGG-Vorbis, is worse than with uncompressed formats such as WAV or FLAC. For the highest reproduction quality we always recommend the use of the Streaming Client or the USB input of the **CALACDR** instead of Bluetooth.

Operating the Disc player

Selecting CD as source

Select the CD player as source by pressing the **DISC** button on the **SRC1**.

Inserting a CD

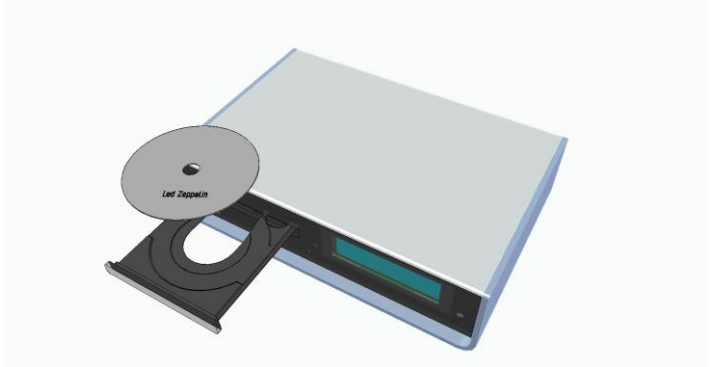

- Open the CD drawer by pressing the **CD** button on the **SRC1**.
- Place the disc **centrally** in the appropriate depression in the drawer, **with the side to be played facing down**.



- Close the CD drawer by pressing the **CD** button on the **SRC1** again.
- When you close the drawer, the machine immediately reads the CD's 'Table of Contents'; the screen displays the message **'Reading'**. During this period all button-presses are ignored.
- The screen then displays the total number of tracks on the CD in the drawer, e.g.: **'13 Tracks 60:27'**.



It also shows the current mode of operation, e.g. .

Playing a CD



Press the  button on the **SRC1** remote control handset to begin the playback process. Playback starts, and the screen shows the mode of operation () and the number of the track currently being played: **'Track 1'**.



The CD stops after the final track, and the screen again displays the total number of CD tracks and the overall running time.

Variations

If you press the  /  button after placing the CD in the machine, the drawer closes and playback starts with the first track.

The open drawer also closes if you enter the number of a track using the remote control handset.



You can interrupt playback at any time by pressing the  button. During the interruption the screen displays the  symbol. Press the  button again to resume playback.

Briefly pressing the  /  button during playback causes the player to skip to the start of the preceding / next track.

A brief press on the  button concludes playback.

A long press on the  button opens the CD drawer.

Track Select During playback



Briefly press the  or  button repeatedly until the number of the track you want to hear appears on the integral screen.

Releasing the button interrupts playback briefly, and after this the desired track is played.



You can also enter the number of the desired track directly using the numeric buttons on the remote control handset.

Fast Search

- Fast forward search (hold the  button pressed in)
- Fast reverse search (hold the  button pressed in)

Holding the button pressed in for a long period increases the rate (speed) of search. During the search process the screen displays the current track running time.

CD Text

If the disc in the drawer contains CD text, this can be superimposed or suppressed by briefly pressing the  button.

Playback mode

The CD player in the CALA CDR features various playback modes. During playback the current playback mode is shown on the screen.



Repeat



Brief press:

Repeatedly pressing the  button causes the machine to cycle through different playback modes.



Screen symbols

	The tracks of the CD or a <i>playback program</i> are continuously repeated in the preset sequence .
	The track of the CD or a <i>playback program</i> which has just been played is continuously repeated.
No symbol	Normal playback of the whole disc, or normal program playback.



Mix mode



Long press:

Holding the  button pressed in switches the machine to Mix mode. A second long press ends Mix mode. A brief press on the  button in Mix mode repeats the playback program.

Screen symbols







	The tracks of the CD or of a playback program are played in a random sequence .
	The tracks of the CD or of a playback program are continuously repeated in a random sequence .

Playback Program



Creating a Playback Program

A playback program consists of up to thirty tracks of a CD stored in any order you like. This can be useful, for example, when you are preparing a cassette recording. A playback program can only be created for the CD currently in the disc drawer of the **CALA CDR**. The program remains stored until it is erased again, or until the CD drawer is opened.

When you place the CD in the drawer, the screen displays the total number of tracks on the disc, e.g.: **'13 Tracks 60:27'**. For creating a playback program the disc must be stopped.



- Press the  button to activate playback programming mode.
- The screen displays the message **'Add Track 1 to Program'** and **'0 Tracks / 0:00 Program time'**.
- Repeatedly press the  or  button briefly until the number of the desired track appears on the screen after **'Track'**.
- Now store the track in the playback program by briefly pressing the  button.
- The screen shows the number of tracks and the total playing time of the play-back program. Select all the remaining tracks of the program in the same manner, and store them by briefly pressing the  button.
- If you store thirty tracks, the screen displays the message **'Program full'**. The playback programming process is concluded when all the desired tracks have been stored.
- End the playback programming process.
- Hold the  button pressed in for about one second





It is also possible to enter the track directly using the numeric buttons, instead of using the  /  buttons. After you enter the number, press the  button briefly to store the track, as described above.

Playing a playback program

The playback program can now be played.

- Start the playback process by a brief press on the  button
Playback starts with the first track of the playback program. The screen displays the message **'Prog'** while a playback program is playing.
The  and  buttons select the previous or next track, but only within the playback program.

Erasing a playback program

- Briefly pressing  button in STOP mode opens the CD drawer, and thereby erases the playback program.
- A playback program can also be erased without opening the CD drawer:
- Erase the playback program.
- Hold the  button pressed in again for about one second
- The playback program is now erased.

The Calas as D/A Converter

General Information on D/A Converter Operation

The **T+A CALA CDR** can be used as a high-quality D/A converter for other devices such as computers, digital radios etc. which are fitted with poor-quality converters or no converter at all. The **CALA CDR** features two optical and one electrical S/P-DIF digital input on the back panel to allow this usage.

- i** You can connect devices with electrical co-axial or optical light-pipe output to the digital inputs of the **CALA CDR**. At the optical inputs DIG 1 and DIG 2 the **CALA CDR** accepts digital stereo signals conforming to the S/P-DIF norm, with sampling rates of 32 to 96 kHz. At the electrical co-axial input DIG 3 the range of sampling rates is from 32 to 192 kHz.

D/A Converter Operation

Selecting a D/A Converter Source

Choose the digital input to which you have already connected the source device which is to be played by pressing the **DIN** button on the **SRC1** (repeatedly if necessary).

As soon as the source device delivers digital music data, the **CALA CDR** automatically adjusts itself to the format and sampling rate of the signal, and you will hear the music.

Front panel display

- i** During D/A converter operations the **CALA CDR** integral screen displays the characteristics of the digital input signal.

Playback with roon

General information

The **CALA CDR** supports playback via Roon. Roon is a fee required software solution that manages and organizes your music stored on a server. Furthermore the streaming service TIDAL can be integrated.

Playback

The operation is exclusively done via the Roon-App. The **CALA CDR** is recognized as a playback device (client) and can be selected for playback in the app. As soon as Roon is used for playback, "Roon" appears on the **CALA CDR** display as source.

- i** Further information about Roon and its operation can be found at: <https://roonlabs.com>



Installation, Using the system for the first time, Safety notes

This section describes all those matters which are of fundamental importance when setting up and first using the equipment. This information is not relevant in daily use, but you should nevertheless read and note it before using the equipment for the first time.

Back panel connections

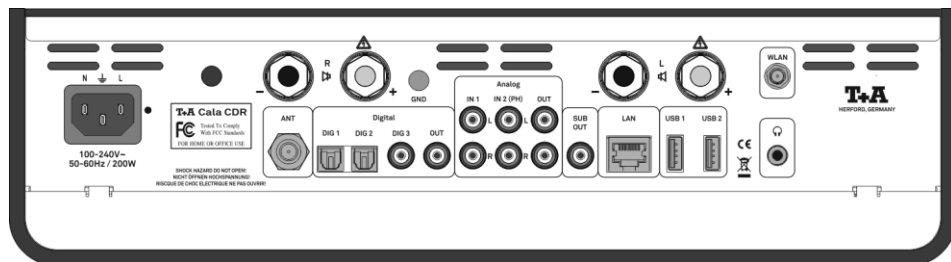

Mains input

The mains lead is plugged into this socket.

For information on correct mains connections please refer to the notes in the Chapters '**Using the system for the first time**', '**Wiring**' and '**Safety Notes**'.

ANT (Aerial input)

The **CALA CDR** features a $75\ \Omega$ aerial input marked **ANT** which is suitable for a cable connection as well as a standard domestic radio aerial. For first-class reception quality a high-performance aerial system, competently installed, is a fundamental necessity.

Digital **DIG 1** Digital **DIG 2**

Inputs for digital source devices with an optical digital output.

At these inputs the **CALA CDR** accepts digital stereo signals conforming to the S/P-DIF norm, with sampling rates of 32 to 96 kHz.

- i** These inputs are equipped with an automatic power on function. Please refer chapter 'System settings / source settings'

Digital **DIG 3**

Input for digital source devices with a co axial digital output.

At this input the **CALA CDR** accepts digital stereo signals conforming to the S/P-DIF norm, with sampling rates of 32 to 192 kHz.

- i** This input is equipped with an automatic power on function. Please refer chapter 'System settings / source settings'

Digital **OUT**

At this socket is the signal from the chosen source available. It can be transmitted to e.g. a digital recorder.



- i** It is not possible to produce a digital version of all played media, as in some cases the original contains copyright protection.

GND

The ground lead from an analogue record player is connected here in order to avoid hum.

Analog IN 1 / IN 2

Universal analogue stereo sound input

-  These inputs are equipped with an automatic power on function. Please refer chapter 'System settings / source settings'
-  In the System Configuration menu it is possible to configure the input **IN 2** as input for an analogue turntable (pick-up).

Analog OUT (🔊)

Analogue audio output (Pre Out), typically for connecting active loudspeakers or headphones.

The level of this output is variable; the level is controlled in parallel with the loudspeaker outputs.

-  A 3.5 mm barrel socket 🎧 is available, wired in parallel with the Cinch / RCA output, for connecting headphones. The function of the two outputs is identical.

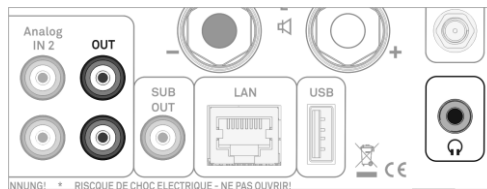

The use of headphones

Continuous listening to programme material via earphones or head-phones at very high volume can result in permanent hearing loss. You can avoid damaging your health by not listening via headphones or ear-phones at high levels for long periods.

SUB OUT

Output socket for an active sub-woofer.
The use of a sub-woofer is optional.

-  If a sub-woofer is connected, it must be switched on in the Loudspeaker menu (see Chapter '**System Settings, Loudspeaker**').

USB 1 USB 2

Sockets for a USB memory stick or external hard discs

The storage medium can be formatted with the FAT16, FAT32, NTFS, ext2, ext3 or ext4 file system.

The USB storage medium can be powered directly via the USB port provided that its current drain is in accordance with the USB norm. Normalised 2.5" USB hard discs can be connected directly, i.e. without a separate mains PSU.

LAN

Router socket

-  If LAN is connected, the LAN connection has priority, and WLAN is automatically disabled.

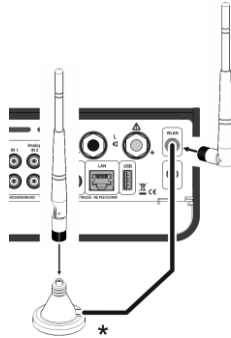

* The aerial can also be set up free-standing using the magnetic base supplied in the set; this ensures maximum possible range.

i **Automatic Activation of the WLAN Module**
After powering on the **MP 2000 R** detects if it is connected to a wired LAN Network. If no wired LAN connection is found, the **MP 2000 R** will automatically activate its WLAN module and it will try to get access to your WLAN network

⚠ Attention!
When WLAN shall be used, the LAN socket must be left unconnected.

⊞ R and ⊞ L
(loudspeaker terminals)

One pair of loudspeakers can be connected to the (SPEAKER ⊞ R and SPEAKER ⊞ L). The impedance of each speaker must not be lower than 4 Ω (DIN rating).

⚠ Attention!
The load capacity of the loudspeakers connected to the device must be appropriate to the amplifier. The speaker impedance must be at least 4 Ohm (DIN rating). Always connect your loudspeakers using ready-made, purpose-designed speaker cables terminating in approved connectors. The speaker cables and connectors must be insulated in accordance with regulations, and the conductors must have a minimum cross-sectional area of 1.5 mm². The output stages are designed to cope with a minimum load of 2 Ω, but continuous operation at very high volume produces high currents in the power output stages which can lead to overheating. This in turn trips the protective circuit which switches the amplifier off automatically. Make sure that the terminals are firmly screwed down, and that no short-circuits are possible.

i If the loudspeakers are to be used in countries outside the EU the red/black stoppers can be removed from the loudspeaker terminals. The speakers can then be connected using banana plugs.

The stoppers are simply a push-fit in the terminals, and can be prised out from the rear using a suitable tool such as a knife blade.

Installation and wiring

Carefully unpack the unit and store the original packing material carefully. The carton and packing are specially designed for this unit and will be needed again if you wish to move the equipment at any time.

If you have to transport the device, it must always be carried or sent in its original packaging in order to prevent damage and defects.

If the unit gets very cold (e. g. when being transported), condensation may form inside it. Please do not switch it on until it has had plenty of time to warm up to room temperature, so that any condensation evaporates completely.

If the device has been in storage, or has not been used for a protracted period (> two years), it is essential to have it checked by a specialist technician before re-use.

Before placing the unit on sensitive lacquer or wood surfaces please check the compatibility of the surface and the unit's feet on a non visible point and if necessary use an underlay. We recommend a surface of stone, glass, metal or the like.

The unit should be placed on a rigid, level base (See also chapter "**Safety notes**"). When placing the unit on resonance absorbers or anti-resonant components make sure that the stability of the unit is not reduced.

The unit should be set up in a well ventilated dry site, out of direct sunlight and away from radiators.

The unit must not be located close to heat-producing objects or devices, or anything which is heat-sensitive or highly flammable.

Mains and loudspeaker cables, and also remote control leads must be kept as far away as possible from signal leads and antenna cables. Never run them over or under the unit.



Notes on connections:

A complete connection diagram is shown in '**Appendix A**'.

- Be sure to push all plugs firmly into their sockets. Loose connections can cause hum and other unwanted noises.
- When you connect the output sockets of the source device to the input sockets of the **CALACDR** always connect like to like, i. e. '**R**' to '**R**' and '**L**' to '**L**'. If you fail to heed this then the stereo channels will be reversed.
- The device is intended to be connected to mains outlet with protective earth connector. Please connect it only with the mains cable supplied to a properly installed mains outlet with protective earth connector.
- To achieve maximum possible interference rejection the mains plug should be connected to the mains socket in such a way that phase is connected to the mains socket contact marked with a dot (●). The phase of the mains socket can be determined using a special meter. If you are not sure about this, please ask your specialist dealer.

If you encounter problems when setting up and using the amplifier for the first time please remember that the cause is often simple, and equally simple to eliminate. Please refer to the section of these instructions entitled '**Trouble shooting**'.

Loudspeaker and signal cables

Loudspeaker cables and signal cables (inter-connects) have a significant influence on the overall reproduction quality of your sound system, and their importance should not be under-estimated. For this reason **T+A** recommends the use of high-quality cables and connectors.

Our accessory range includes a series of excellent cables and connectors whose properties are carefully matched to our speakers and electronic units, and which harmonise outstandingly well with them.

For difficult and cramped situations the **T+A** range also includes special-length cables and special-purpose connectors (e. g. right-angled versions) which can be used to solve almost any problem concerning connections and system location.

Changing the batteries

To open the battery compartment, slide the entire back of the remote down as shown below and then lift it off. Insert three batteries of the **LR 03 (MICRO)** type in the battery compartment, as shown in the engraved diagram. Please note: it is essential to **replace all three batteries at the same time**.

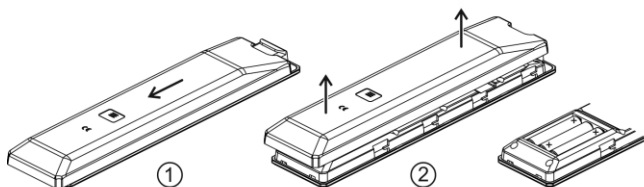

Caution!

Batteries should not be exposed to excessive heat like sunshine, fire or the like.



Disposing of exhausted batteries:

Exhausted batteries must never be thrown into the household waste! They should be returned to the battery vendor (specialist dealer) or your local toxic waste collection point, so that they can be recycled or disposed in a proper way. Most local authorities provide collection centres for such waste, and some provide pick-up vehicles for old batteries.

Care of the unit

Disconnect the mains plug at the wall socket before cleaning the case. The surfaces of the case should be wiped clean with a soft, dry cloth only.

Never use solvent-based or abrasive cleaners!

Before switching the unit on again, check that there are no short-circuits at the connections, and that all cables are plugged in correctly.

Storing the unit

If the device has to be stored, place it in its original packaging and store it in a dry, frost-free location. Storage temperature range 0...40 °C

Safety notes

For your own safety please consider it essential to read these operating instructions right through, and observe in particular the notes regarding setting up, operation and safety.

Installation

Please consider the weight of the device. Never place the device on an unstable surface; the machine could fall off, causing serious or even fatal injury. Many injuries, especially to children, can be avoided if the following simple safety precautions are observed:

- Use only such items of furniture which can safely bear the weight of the device.
- Ensure that the device does not project beyond the edges of the supporting furniture.
- Do not place the device on tall furniture (e.g. bookshelves) without securely anchoring both items, i.e. furniture and device.
- Explain to children the hazards involved in climbing on furniture to reach the device or its controls.

When installing the unit on a shelf or in a cupboard it is essential to provide an adequate flow of cooling air, to ensure that the heat produced by the unit is dissipated effectively. Any heat build-up will shorten the life of the unit and could be a source of danger. Be sure to leave free space of 10 cm around the unit for ventilation.

If the system components are to be stacked then the amplifier must be the top unit. Do not place any object on the top cover.

The unit must be set up in such a way that none of the connections can be touched directly (especially by children). Be sure to observe the notes and information in the section '**Installation and Wiring**'.

Power supply

The device is intended to be connected to mains outlet with protective earth connector. Please connect it only with the mains cable supplied to a properly installed mains outlet with protective earth connector.

The power supply required for this unit is printed on the mains supply socket. The unit must never be connected to a power supply which does not meet these specifications. If the unit is not to be used for a long period disconnect it from the mains supply at the wall socket.

Mains leads / Mains plug

Mains leads must be deployed in such a way that there is no danger of damage to them (e. g. through persons treading on them or from furniture). Take particular care with plugs, distribution panels and connections at the device.

Unplugging the mains plug will disconnect the device from the mains for service and repair. Please make sure that the mains plug is easily accessible.

Enclosure openings

Liquid or particles must never be allowed to get inside the unit through the ventilation slots. Mains voltage is present inside the unit, and any electric shock could cause serious injury or death. Never exert undue force on mains connectors.

Protect the unit from drips and splashes of water; never place flower vases or fluid containers on the unit.

Do not place naked flame sources, such as candle lights on the device.

Supervision of device operation

Like any other electrical appliance this device should never be used without proper supervision. Take care to keep the unit out of the reach of small children.

Service, Damage

The case should only be opened by a qualified specialist technician. Repairs and fuse replacements should be entrusted to an authorised **T+A** specialist workshop. With the exception of the connections and measures described in these instructions, no work of any kind may be carried out on the device by unqualified persons.

If the unit is damaged, or if you suspect that it is not functioning correctly, immediately disconnect the mains plug at the wall socket, and ask an authorised **T+A** specialist workshop to check it.

Approved usage



The device is designed to operate in a temperate climate and altitudes up to 2000 m above sea level. The range of permissible operating temperatures is +10 ... +35°C.

This device is designed exclusively for reproducing sound and/or pictures in the domestic environment. It is to be used in a dry indoor room which meets all the recommendations stated in these instructions.

Where the equipment is to be used for other purposes, especially in the medical field or any field in which safety is an issue, it is essential to establish the unit's suitability for this purpose with the manufacturer, and to obtain prior written approval for this usage.

Over voltage

The unit may be damaged by excess voltage in the power supply, the mains circuit or in aerial systems, as may occur during thunderstorms (lightning strikes) or due to static discharges.

Special power supply units and excess voltage protectors such as the **T+A 'Power Bar'** mains distribution panel offer some degree of protection from damage to equipment due to the hazards described above.

However, if you require absolute security from damage due to excess voltage, the only solution is to disconnect the unit from the mains power supply and any aerial systems.

To avoid the risk of damage by overvoltages we recommend to disconnect all cables from this device and your HiFi system during thunderstorms.

All mains power supply and aerial systems to which the unit is connected must meet all applicable safety regulations and must be installed by an approved electrical installer.

Approval and conformity with EC directives

In its original condition the unit meets all currently valid European regulations. It is approved for use as stipulated within the EC. By attaching the CE symbol to the unit **T+A** declares its conformity the EC directives and the national laws based on those directives. The declaration of conformity can be downloaded from www.ta-hifi.com/DoC.

The original, unaltered factory serial number must be present on the outside of the unit and must be clearly legible! The serial number is a constituent part of our conformity declaration and therefore of the approval for operation of the device. The serial numbers on the unit and in the original **T+A** documentation supplied with it (in particular the inspection and guarantee certificates), must not be removed or modified, and must correspond.

Infringing any of these conditions invalidates **T+A** conformity and approval, and the unit may not be operated within the EC. Improper use of the equipment makes the user liable to penalty under current EC and national laws.

Any modifications or repairs to the unit, or any other intervention by a workshop or other third party not authorised by **T+A**, invalidates the approval and operational permit for the equipment.

Only genuine **T+A** accessories may be connected to the unit, or such auxiliary devices which are themselves approved and fulfil all currently valid legal requirements.

When used in conjunction with auxiliary devices or as part of a system this unit may only be used for the purposes stated in the section '**Approved usage**'.

Disposing of this product



The only permissible method of disposing of this product is to take it to your local collection centre for electrical waste.

FCC Information to the user

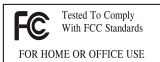

(for use in the United States of America only)

Class B digital device – instructions:

Note: This equipment has been tested and found to comply with the limits for a Class B digital device, pursuant to Part 15 of the FCC Rules. These limits are designed to provide reasonable protection against harmful interference in a residential installation. This equipment generates, uses and can radiate radio frequency energy and, if not installed and used in accordance with the instructions, may cause harmful interference to radio communications. However, there is no guarantee that interference will not occur in a particular installation. If this equipment does cause harmful interference to radio or television reception, which can be determined by turning the equipment off and on, the user is encouraged to try to correct the interference by one or more of the following measures:

- Reorient or relocate the receiving antenna.
- Increase the separation between the equipment and receiver.
- Connect the equipment into an outlet on a circuit different from that to which the receiver is connected.

Consult the dealer or an experienced radio/TV technician for help.

Network Configuration

General Information

The **CALA CDR** can be operated in wired LAN networks (*Ethernet LAN* or *Powerline LAN*) or in wireless networks (*WLAN*).

If you wish to use your **CALA CDR** in your home network, you must first enter the necessary network settings on the **CALA CDR**. This includes entering the network parameters such as the IP address etc. both for wired and wireless operation. If you wish to use a wireless connection, a number of additional settings for the WLAN network also have to be entered.



In the following sections we assume that a working home network (cable network of WLAN network) with router and (DSL) Internet access is present.

If you are unclear about some aspect of installing, setting up and configuring your network, please address your queries to your network administrator or a network specialist.

Compatible hardware and UPnP servers

The marketplace offers a vast number of routers, NAS devices and USB hard discs made by a very wide range of manufacturers. **T+A** equipment is generally compatible with other makes of machine which bear the UPnP label.

Network settings menu



All network settings are entered in the Network Configuration menu. This menu will vary slightly in appearance depending on the type of your network, i.e. whether you have a wired (LAN) or wireless (WLAN) network.

If in the Network Configuration Menu the entry 'Network IF Mode' is set to 'auto', the **CALA CDR** will check automatically if a LAN connection to a network is present. If a LAN connection is found, the machine will assume that this is to be used, and displays the network configuration menu for LAN networks.



If no LAN network is connected, the **CALA CDR** activates its WLAN module and displays the WLAN configuration menu when you call up the configuration menu. The menu for a WLAN network includes a number of additional menu points. The following sections explain how to use the menu, and the meaning of the individual menu points.

Opening the network settings menu



Open the System Configuration menu by pressing the  button on the remote control handset.



Use the  /  buttons to select the "Network" menu item, then confirm by pressing the  button.

Operating the menu, changing and storing IP addresses

Use the  /  buttons in the menu to select the network parameter to be changed, and activate the entry with the  button.

You can now change the setting using the following buttons, depending on the type of setting:

 /  button for simple selection (ON / OFF)

Numeric buttons  to  for entering IP addresses

Alpha-numeric input for entering text

When the setting process is complete, or when you have entered the complete address, press the  button to confirm your action.

Alpha-numeric entry

At certain points, e.g. for entering server names or passwords, it is necessary to input series of characters (strings). At such points you can enter letters, numbers and special characters by repeatedly pressing the numeric buttons on the **SRC1** remote control handset, as when writing SMS news. The assignment of letters to the buttons is printed below the buttons. Special characters can be accessed using the  and

 buttons:

 0 + - * / ^ = { } () [] < >

 . , ? ! : ; 1 \ " ' _ @ \$ % & # ~





Use the blue  button for toggling between numbers, capitals and lower-case letters. The bottom line of the screen shows which input mode is currently selected.

 At certain points (e.g. DNS server name) it is possible to enter both an alpha-numeric string and an IP address. At these points an IP address should be entered like a string (with separating dots as special characters). In this case an automatic check for valid address ranges (0 ... 255) is not carried out.

Closing the menu

Once you have correctly set all the parameters, select the menu item '**Store and exit?**', then press the  button. This action causes the **CALA CDR** to accept the settings, and you should see the available network media sources (Internet radio, UPnP-AV server, etc.) displayed in the main menu.

Interrupting the menu without storing the settings

At any time you can leave the network configuration menu without making any changes to the network settings: this is done by pressing the  button, which takes you to the menu item '**Store and exit?**'. If you wish to quit at this point without saving, use the  /  buttons to select the '**Discard and exit?**' menu item, then confirm with the  button.

The Configuration for a Wired Ethernet LAN or Power-Line LAN connection

Setting the Parameters for a Wired Network

- Connect the **CALACDR** to an operational network or Power-Line modem using the LAN socket on the back panel.
- Open the System Configuration menu by pressing the **sys** button on the remote control handset or the front panel of the **CALACDR**.
- Use the **▲** / **▼** buttons to select the **"Network"** menu point, then confirm by pressing the **OK** button.
- You should now see the menu reproduced below, displaying the network parameters. In the title line the message 'LAN' should appear, indicating that the machine is connected to a wired LAN. If you see 'WLAN' at this point instead, please check your network connection, and ensure that the network is switched on and operational.
- You can now select the individual menu points and adjust them to match your network conditions. The illustration below shows the possible button inputs after each menu item.

Network settings menu		Possible entries
MAC	00:0e:9b:cc:a4:35	none
Connection state	LAN	none
→ DHCP	Off	◀ / ▶ (0 ... 9)
IP	192.168.0.10	(0 ... 9)
Subnet mask	255.255.255.0	(0 ... 9)
Gateway	192.168.0.1	(0 ... 9)
DNS	192.168.0.1	(0 ... 9, A ... Z)
Store and exit?	apply	OK
Discard and exit?	apply	OK

- ◀** / **▶**: Switching ON / OFF
- (0...9): Numeric input, separating dots are automatically generated; input limited to valid addresses
- (0...9, A...Z): Alpha-numeric input and special characters.

IP - separating dots must be entered as special characters.

i The parameters illustrated above are only typical values. Addresses and settings may require different values for your network.

Menu Point	Description
MAC	The MAC address is a hardware address which uniquely identifies your machine. The address displayed is determined by the manufacturer, and cannot be altered.
Connection state	Shows the connection state: WLAN, LAN or not connected.
DHCP	<p data-bbox="353 338 387 359">ON</p> <p data-bbox="353 363 1050 485">If your network includes a DHCP server, please select the ON setting at this point. In this mode an IP address is automatically assigned to the CALA CDR by the router. The screen shows only the MAC address and the message DHCP state ON. In this case the address input fields shown in the illustration do not appear in the menu.</p> <p data-bbox="353 504 398 525">OFF</p> <p data-bbox="353 529 1050 624">If your network does not include a DHCP server, please select the OFF setting. In this mode you must configure the following network settings manually. Please ask your network administrator for the addresses to be entered for your network.</p>
IP	IP address of the CALA CDR
Subnet mask	Network mask
Gateway	IP address of the router
DNS	Name / IP of the name server (optional)
Store and exit?	Stores the network parameters, and restarts the CALA CDR with the new settings.
Discard and exit?	Closes the menu: data already entered is discarded.

The Configuration for a WLAN connection

Setting the parameters for a wireless network

- Now switch the **CALA CDR** on, and open the System Configuration menu by pressing the **sys** button on the remote control handset or the front panel of the **CALA CDR**.
- Use the **▲** / **▼** buttons to select the menu point **“Network”**, then confirm your choice with the **OK** button.
- The following menu now opens:

settings

Network settings menu

MAC	00:0e:9b:cc:a4:35	none
Connection state	not connected	none
Interface	WLAN	◀ / ▶
→ WPS Autoconnect	apply	OK
Scan for WLAN	apply	OK
WLAN Access Point	apply	OK
DHCP	Off	◀ / ▶
IP	192.168.0.10	(0 ... 9)
Subnet mask	255.255.255.0	(0 ... 9)
Gateway	192.168.0.1	(0 ... 9)
DNS	192.168.0.1	(0 ... 9, A ... Z)
Store and exit?	apply	OK
Discard and exit?	apply	OK

Selecting and connecting a WLAN by hand

Searching for and Selecting the Network

- First select the menu point **“Scan for WLAN”**, and activate it by pressing the **OK** button.
- A list of the WLANs found is displayed on the screen.
- Use the **▲** / **▼** buttons to select the WLAN to which you wish the **CALA CDR** to be connected, and confirm your choice with the **OK** button

Entering the Password (for encoded networks)

If the network is encoded, the window shown below will appear once the WLAN is selected.

At this point please enter the network passphrase and confirm your input by pressing **OK**.

Select the **“Store and exit?”** point, and confirm your choice with

OK.

Network settings menu

SSID:	Name of the WLAN	none
Login:	Man. (WPA/WPA2)	none
→ Passphrase:	xxxxxxx	(0 ... 9, A ... Z)
Store and exit?	apply	OK

Storing Network Settings and Restarting





Finally select the **“Store and exit?”** menu point and press the  button to accept the settings.

Connecting to WLAN via the WPS-function

WPS-function





The **CALACDR** supports WPS for WLAN setup. WPS (Wi-Fi Protected Setup) an easy process for establishing a secure WLAN connection. WPS can be used to connect the **CALACDR** with your router in a quick and convenient way. For that usage most modern routers have implemented the WPS function.





Connecting WLAN automatically via the WPS function

- First activate the WPS-function of the Router or Repeater to which you wish the **CALACDR** to be connected. For details please refer the manual of the device in question.
- Start the WPS-Autoconnect function of the **CALACDR** within 2 minutes.
- Use the  /  buttons to select the menu point **“WPS-Autoconnect”**, then confirm your choice with the  button.
- After the connection is established, the line **“Status”** shows the connected WLAN network.
- Finally select the **“Store and exit?”** menu point and press the  button to accept the settings.

Selecting the WLAN manually and connecting via WPS







If the WPS function connects the **CALACDR** to the wrong WLAN, the preferred WLAN can be also selected manually and only the authentication can be done by the WPS function. The procedure is described in the following:

- First activate the WPS-function of the Router or Repeater to which you wish the **CALACDR** to be connected. For details please refer the manual of the device in question.
- First select the menu point **“Scan for WLANs”**, and activate it by pressing the  button.
- A list of the WLANs found is displayed on the screen.
- Use the  /  buttons to select the WLAN to which you wish the **CALACDR** to be connected, and confirm your choice with the  button

- Select the “**Login**” menu point and press the  button to activate it. Now select the setting „**Auto (WPS)**“ and confirm it with the  button.
- Now select the “**Store and exit?**” menu point and press the  button.
- After the connection is established, the line “Status” shows the connected WLAN network.
- Finally select the “**Store and exit?**” menu point and press the  button to accept the settings.

WLAN setup via access point

The **CALA CDR** supports setting up the WLAN connection via an access point. This means that the **CALA CDR** provides its own WLAN for the duration of the configuration of the WLAN settings. As soon as the configuration is complete, this WLAN is deactivated again. The **CALA CDR** restarts and connects to the WLAN configured via the app.

- Turn on the **CALA CDR** and open the system configuration menu by pressing the  button on the remote control.
- Use the  /  buttons to select the menu point “Network”, then confirm your choice with the  button.
- Use the  /  buttons to select the menu point “Access Point”, then confirm your choice with the  button.
- The **CALA CDR** activates the WLAN access point..
- The following steps must be performed within approximately 5 minutes. After this time, the **CALA CDR** will exit Access point mode automatically.
- Connect the smartphone or Tablet PC on which the **T+A**-App is installed to the WLAN access point. The network name (SSID) is “T+A AP **CALA CDR** “ and the passphrase is “01234567”.
- Start the **T+A** -App for operation.
- The app recognizes the access point and starts automatically with the setup wizard.
- To set up the WLAN, go through the individual steps of the app's setup wizard.
- Quit the app, then connect your phone or tablet to your previously set up wireless LAN.
- After restarting the app the **CALA CDR** will be detected automatically.
- Once the **CALA CDR** is detected, it can be selected for playback.

Trouble shooting

Many problems have a simple cause and a correspondingly simple solution. The following section describes a few difficulties you may encounter, and the measures you need to take to cure them. If you find it impossible to solve a problem with the help of these notes please disconnect the unit from the mains and ask your authorised **T+A** specialist dealer for advice.

Machine does not switch on	Cause 1: Mains lead not plugged in correctly. Remedy: Check connection, push connector in firmly.
Machine cannot be controlled by IR remote control.	Cause 1: Incorrectly inserted batteries or flat batteries in the remote control handset. Remedy: Re-install batteries correctly or fit new ones. Cause 2: The remote control transmitter has no direct line-of-sight with the unit. Remedy: Make sure that the remote control transmitter has direct line-of-sight contact with the receiver - note that glass doors can interrupt the connection. Maximum range between transmitter and receiver: approx. 8 metres. Be sure to position the receiver where it is not subjected to direct sunlight or very bright artificial light. Fluorescent tubes and energy-saving lamps are powerful sources of interference.
App cannot find the device in powered off state.	Cause: Energy saver is switched on. Remedy: Switch off the Energy saver function in the system configuration menu.
The streaming client cannot connect to a network. On the display the indication 'Cannot connect to network' is displayed.	Cause 1 (cable LAN): Network cable not properly connected Remedy: Connect network cable, check connection to router Cause 2 (wireless LAN): WLAN antenna not connected or placed in a location with bad reception quality Remedy: Connect WLAN antenna properly and find a location with good reception quality. Set the transmission power output of your WLAN router to maximum. Try to establish a network connection first in a location close to the WLAN router. If this succeeded try to connect to WLAN from a more remote location. Experiment with antenna position and try to find a location with better reception quality.

Cause 3 (wireless LAN):

WLAN reception quality bad (low field strength). Possibly too much attenuated by walls/ceilings on the transmission path.

Remedy:

Optimize location of receiver and transmitter antennas.

Alternative:

If transmission problems persist a so called 'Power Line' network might be good alternative to establish a good and stable network connection.

The best, safest and most secure network however will always be a cable LAN network.

Cause 4:

Network parameters not properly configured.

Remedy:

Configure the network parameters correctly (see chapter 'Network configuration').

Cause 5 (operation without network connection):

For proper operation the CALA CDR needs at least one properly connected network device. This can be a LAN or WLAN network or a USB storage device.

Remedy:

If the CALA CDR shall be operated without network (LAN / WLAN) please connect at least a USB stick.

The streaming client does not respond to operation**Cause :**

The streaming client must be restarted.

Remedy:

To restart the Streaming Client, turn off the device. Then switch it back on with a long press on the  button. The client restarts.

Software update

Software update generally

Software updates keep your **CALA CDR** up-to-date. They bring new optimisations like faster operation and new features which were not available at the time the device was produced.



It may occur that after a software update some of your user defined settings like network parameters or favourite stations are lost and have to be restored after the update.

Updating via the Internet

Updating the firmware via the CALA CDR's Internet connection

- The basic requirement is a functioning network with router and access to a broadband Internet connection; the system must be operating.
- Switch the machine on.
- Call up the system configuration menu by pressing the **sys** button on the remote control handset.
- Use the **▲** / **▼** buttons to select the “**Device info**” menu item, and confirm your selection by pressing the **OK** button.
- Select the “**Update**” menu point with the **▲** / **▼** buttons, then press the **OK** button to confirm your choice.
- The Select option “**WEB**” should now be active (highlighted).
- The firmware update can now be started by pressing **OK**.
- The screen displays the current state of progress of the update.
- Once the update has been completed (duration around ten minutes) the device automatically switches itself off and restarts.
- When the machine has restarted, the update is complete.
- To ensure that the update was successful, access the “**Device Info**” menu point mentioned above, and check the new firmware status.

Notes on Energy Saving

General information

The **CALACDR** satisfies the requirements of the latest directives concerning energy-saving measures (EuP directive). The modern design of the mains power supply makes an important contribution to this.

The internal micro-processor constantly ensures that sub-assemblies which are not currently required are automatically switched off. The micro-processor itself operates in stand-by mode at a relatively low clock speed, and only responds to the remote control receiver.

In stand-by mode the current drain of the **CALACDR** is less than 0.5 Watt.

If you intend not to use the device for a long period, it should be disconnected from the mains socket, i.e. the mains plug should be withdrawn from the wall socket.

Automatic power-down (Energy saver)

The device features an automatic power-down function. If the **CALACDR** detects no operation or no music signal for a period longer than ninety minutes, it automatically switches to stand-by mode. Two minutes before the device enters the standby mode, a pop-up window appears on the screen. If the device should stay in operation please press the **OK** button while this message is displayed.

i In countries outside the EU, in which the EuP directive has no validity, the automatic power-down feature can be disabled if necessary (see chapter entitled 'Basic settings of the **CALACDR**).

Legal Information

General information

This product contains software in form of object code that is partially based on free software under different licenses. Details of the licenses used can be viewed on the device website using an Internet browser.

Show licenses

To access the device website, enter the IP address of the device and "/licenses/" in the address line of the browser you are using.

For example <http://192.168.178.100/licenses/>

You can display the exact address as follows:

- Call up the system configuration menu by pressing the **sys** button.
- Then navigate to the "Device Info" menu item. Open it by pressing the **OK**-button.
- Navigate to the menu item "Legal information" and open it with the **OK**--button.

The pop-up window that now opens shows the address of your device.

i The address is only displayed in the pop-up window if the device has a correctly configured network connection. For details on network configuration, see the "Network Configuration" section.

To view the web page of the **T+A** device, the device on which the Internet browser is started must be connected to the same network as the **T+A** device.

Appendix A

Wiring diagram

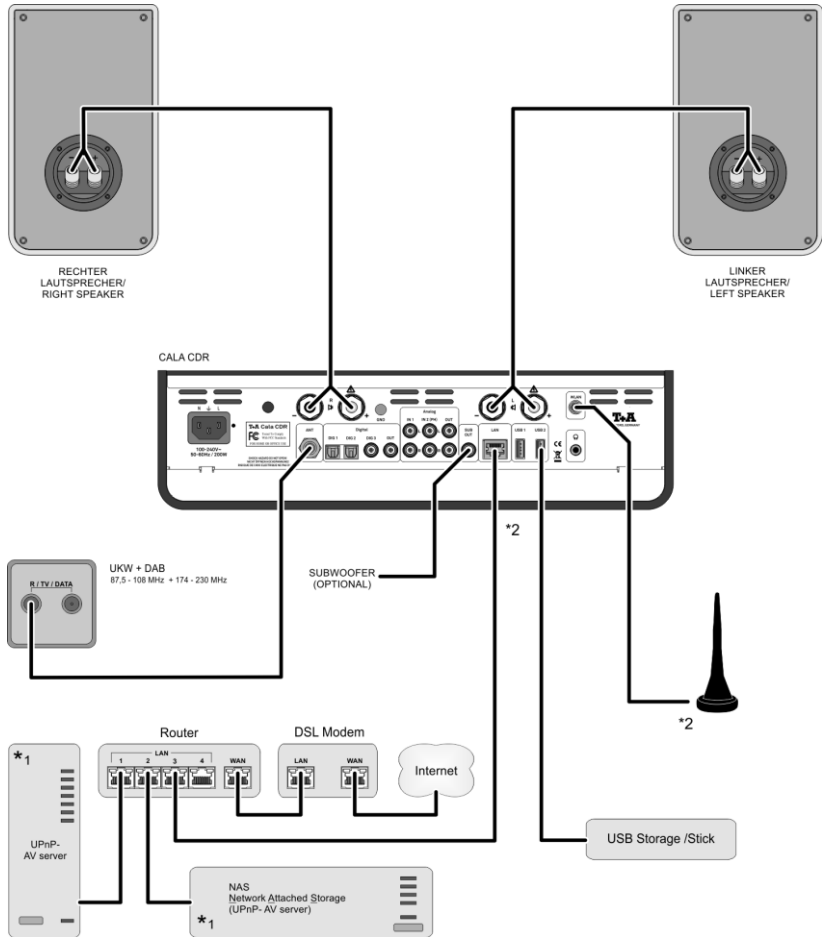

Attention!

A properly set up home network with router must be installed and in operation to use the CALACDR. For the use of internet radio a DSL access to the internet is needed.

For questions regarding setting up your network and internet connection please ask your system administrator or any network specialist.

*1 Music server with UPnP-AV server software installed

*2 Connection either via Cable-LAN or Wireless-LAN

Wiring diagram

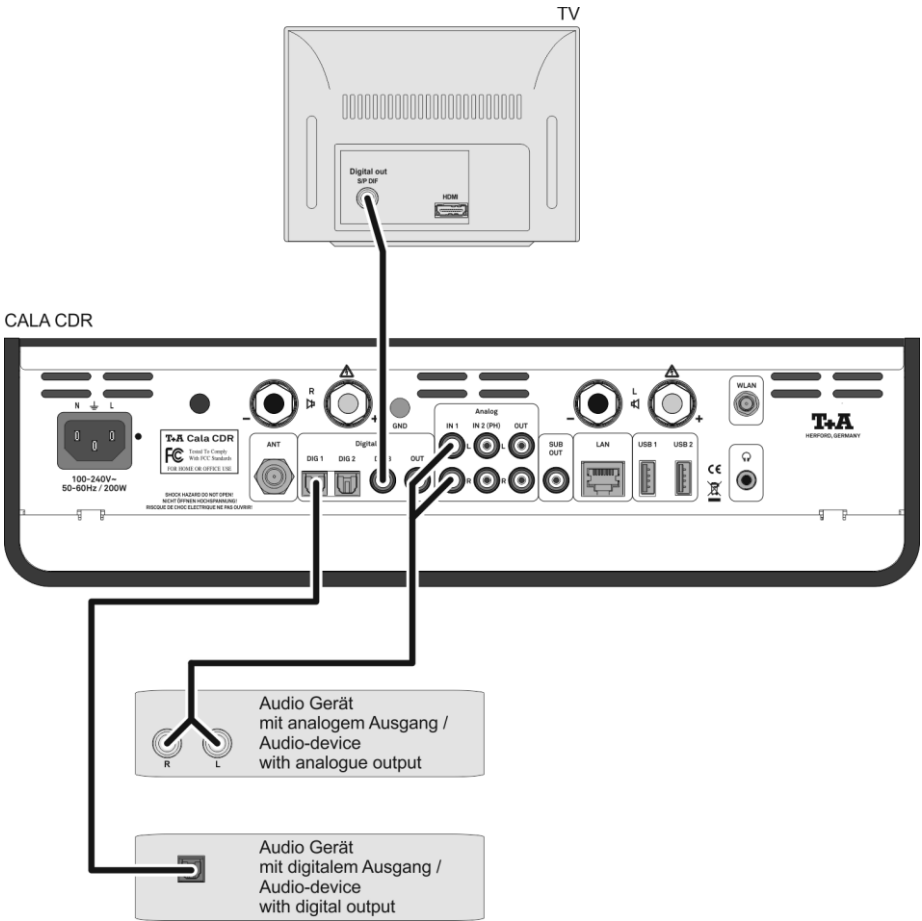

Wiring diagram

Note!

Please note that the digital radio DAB+ and the analogue FM radio transmitting in different frequency ranges. Depending on the existing antenna configuration, it may therefore be necessary to combine the two ranges with a DAB+/UKW feed-in crossover. When using an indoor antenna, do not place it in close proximity to sources of interference such as cordless telephones, WLAN routers or LED lights.

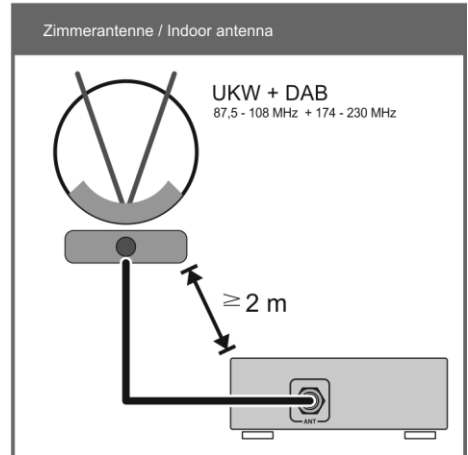
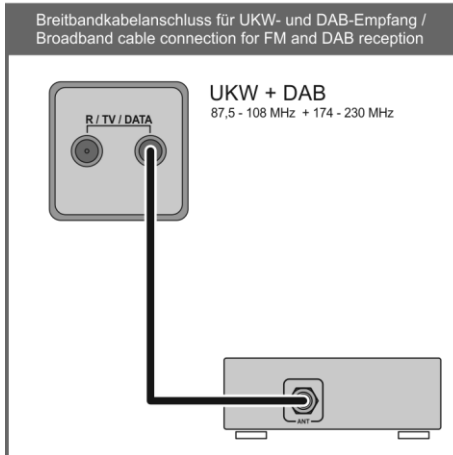
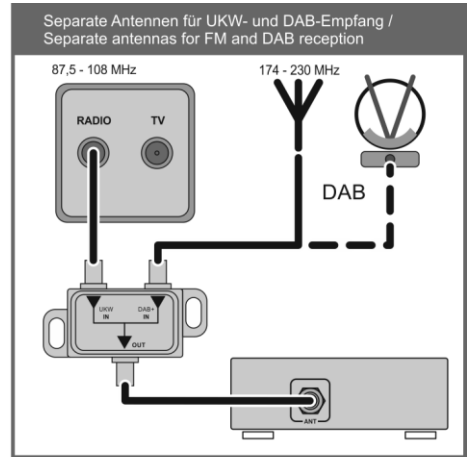
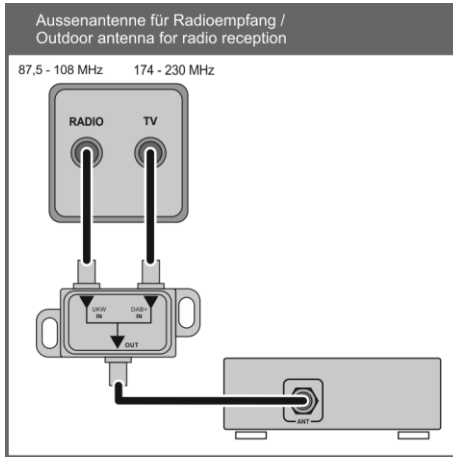

Appendix B

Specification

CD Player	
Formats	CD/DA,CD-R, CD-RW / CD-Text
Frequency response	2 Hz - 20 kHz/100 dB
Streaming Client	
Formats	MP3, WMA, AAC, AIFF, OGG-Vorbis, FLAC + WAV
Data rates	PCM 32...192 kHz,16/32 Bit; MP3 up to 320 kBit; constant and variable data rate
Services	Tidal, Deezer, qobuz (subscription required)
Media server	UPnP AV, Media Player 10 (WMDRM10), DLNA compatible servers
Interfaces	LAN: Fast Ethernet 10/100 Base-T, WLAN: 2,4 GHz, +20 dBm (100 mW), IEEE 802.11 b/g/n
Bluetooth	
	A2DP Bluetooth audio transfer protocol with AVRCP
Formats	MP3, AAC, SBC
Frequency band	2,4 GHz
Max. transmit power	+4dBm (2,5 mW)
USB	
	2x USB 2.0 Mastermode
Radios	
Internetradio	airable Internet Radio Service (> 11000 Stations worldwide)
FM, FM-HD	87,5 - 108 MHz; Empfindlichkeit 1 µV; S/N > 65 dBA
DAB, DAB+	168 -240 MHz (Band III); Sensitivity 2,0 µV, S/N > 96 dBA
Features	RDS/RDBS, Station name (PS), Program type (PTY), Radiotext (RT), Clock

Amplifier Section	
Inputs	2x AUX, 500mV....2,75V / 20 kΩ variable sensitivity SP/DIF (16-24bit): 1x coax (192kHz), 2x TOS-Link (96kHz)
RMS power output into 4 Ohms	2 x 100 Watt
T.H.D.	<0,02 %
Sound Management	DSP controlled sound characteristics
Bass Management	Full range, 40 Hz, 60 Hz, 100 Hz, 150 Hz
Outputs	Pre-Amp, Subwoofer, Headphone digital IEC 60958 (CDDA/LPCM)
Power requirement	100 – 240 V, 50 – 60 Hz
Power consumption (max.)	200 W
Standby (ECO)	0,5 W
Auto power off function	Yes (after 90 minutes without audio signal)
Dimensions	10,5 x 37 x 24,5 cm
Weight	6 kg
Accessories	Remote control SRC1, WLAN antenna, user manual

We reserve the right to alter specifications.



T+A elektroakustik GmbH & Co. KG
Planckstraße 9 – 11
D - 32052 Herford

T +49 (0) 5221 / 7676-0
F +49 (0) 5221 / 7676-76

info@ta-hifi.com
www.ta-hifi.com