

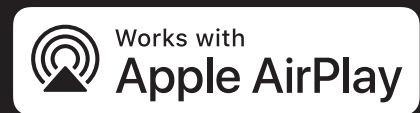

ONE Cast

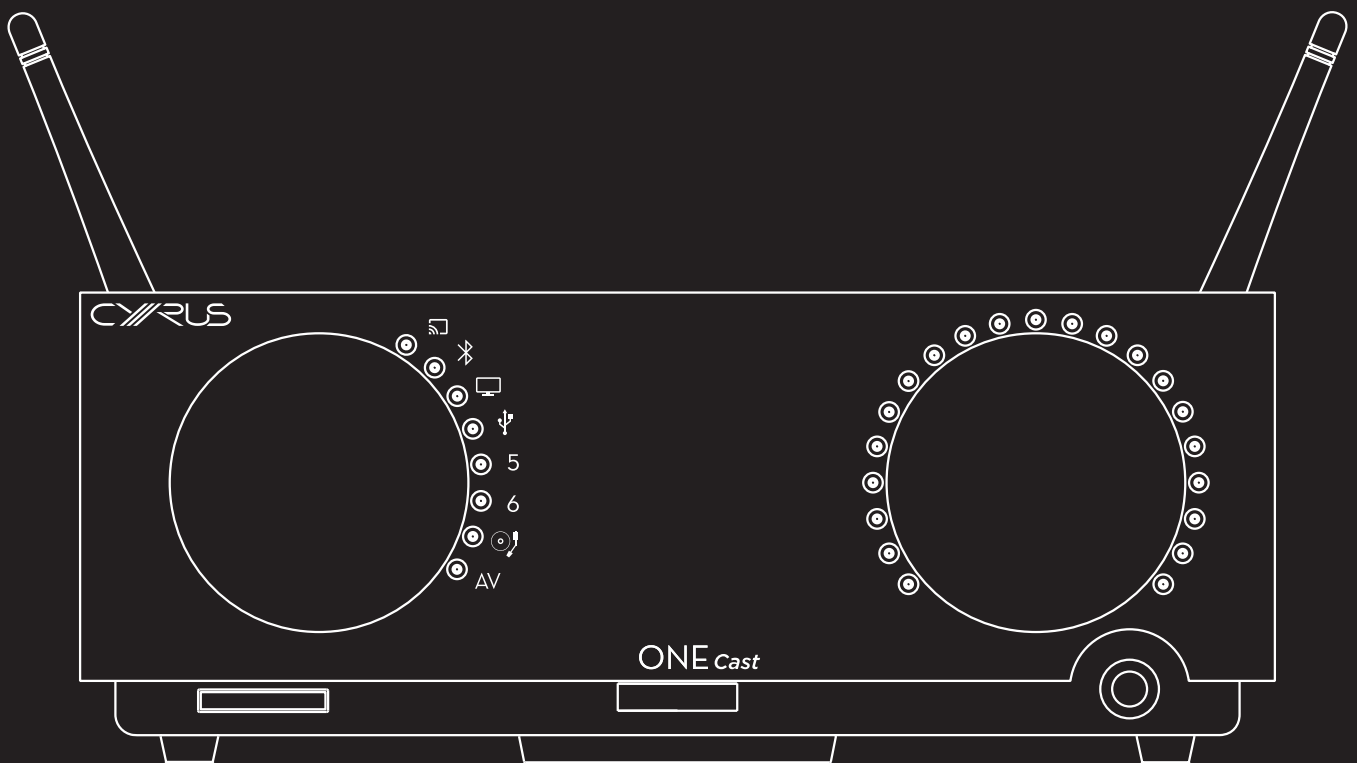

*This ONE Cast is compatible
with AirPlay 2.
iOS 11.4 or later is required.*

CYRUS

Contents

Important! Read before operating this equipment!	1	Setting up Wi-Fi	13
Power supply	2	Choosing a Wi-Fi setup method.....	13
Power consumption in Standby.....	2	Options	13
Operating environment	2	What do I need?	13
Servicing	2	Will the ONE Cast remember my Wi-Fi settings?.....	13
Product service centres.....	2	Can I change the wireless settings?	13
Legal notices	3	Broadband usage	13
WEEE	3	Full wi-fi setup	14
FCC NOTICE*	4	Preparation	14
Introduction	5	Setup.....	14
Welcome to the world of Cyrus!.....	5	Completing setup.....	14
Preparations for Installation	5	Setup failure.....	14
What does ONE Cast do?	5	AirPlay wi-fi setup.....	15
Installation	6	Preparation	15
Back panel features	6	Factory reset before setup.....	15
Connections.....	7	Setup.....	15
Important – read before connecting anything.....	7	Completing setup.....	15
What can I connect?	7	Setup failure.....	15
Connect a turntable	7	Setting up to use with Amazon Alexa	16
Connect digital audio	7	Initial Wi-Fi setup.....	16
Connect HDMI (ARC).....	7	Nuvola skill and UNDOK app.....	16
Connect USB audio	7	Installing the Alexa app.....	16
Connect analogue line audio	7	Register the Nuvola skill in the Alexa app	16
Connect speakers.....	7	Installing the UNDOK app	16
Connect mains power	7		
Controls and features	8		
Front panel features	8		
Front panel	9		
Standby.....	9		
Standby indicator	9		
Auto standby.....	9		
Selecting an input source.....	9		
Status indicator 	9		
Volume.....	9		
Listening through headphones	9		
Disconnecting headphones.....	9		
Remote control	10		
Remote control features	10		
Fitting/Replacing the remote control batteries	10		
Battery disposal	10		
Standby	11		
Control lock.....	11		
Volume.....	12		
Mute	12		
Balance	12		
Input select	12		
Indicator brightness	12		

Contents

Operation.....	17	Bluetooth audio.....	22
Using Google Cast to play music.....	17	First time use/pairing.....	22
How does casting work?.....	17	Disconnecting a mobile.....	22
Which apps are cast enabled.....	17	Re-connecting.....	22
Before first use, check Wi-Fi setup.....	17	Clearing the <i>Bluetooth</i> memory.....	22
Playing music.....	17	Playing music.....	22
Volume control.....	17	Volume control.....	22
Play, pause, track selection etc.....	17	Playing connected sources.....	23
Casting from Standby.....	17	Playing a vinyl turntable.....	23
Dynamic range setting.....	17	Playing an analogue source.....	23
Voice control of a ONE Cast from a mobile.....	18	Playing digital sources.....	23
Voice control of a ONE Cast from other Google Home devices.....	18	Playing USB digital audio sources (USB B input).....	23
Setting up speaker groups.....	18	Playing DSD audio (USB B input).....	23
Playing music via Apple AirPlay.....	19	Playing HDMI (ARC) sound.....	23
How does ONE Cast work in an Apple AirPlay system?.....	19	Advanced operation.....	24
Preparation.....	19	AV Direct mode.....	24
Playing music.....	19	Factory reset.....	25
Volume control.....	19	Cleared settings.....	25
Play, pause, track selection etc.....	19	Reset options.....	25
AirPlay from Standby.....	19	Resetting with optional factory reset.....	25
Voice commands using Siri.....	20	Resetting with automatic factory reset.....	25
Using voice commands with an AirPlay system.....	20	Firmware update.....	26
Multiple speaker systems.....	20	Automatic update.....	26
Using Amazon Alexa to play music.....	21	First use.....	26
Initial setup checks.....	21	Routine updates.....	26
Preparation.....	21	Priority updates.....	26
Playing music.....	21	Update indication.....	26
Volume control.....	21		
Play, pause, track selection etc.....	21		
Alexa commands from Standby.....	21		
Voice control using Alexa.....	21		
Multi-room audio.....	21		

Contents

Troubleshooting	27	Specifications and warranty.....	32
No sound or problems with the sound	27	ONE Cast specifications	32
No sound, basic checks	27	Power Supply	32
No sound when streaming audio via Wi-Fi	27	Power Consumption	32
No sound when playing <i>Bluetooth</i> audio	27	Enclosure	32
No sound, digital inputs 5 and 6	28	Analogue audio performance	32
No sound, USB audio	28	Cable and optical digital audio.....	32
No sound, DSD audio playback via USB	28	USB digital audio.....	32
No sound, HDMI audio.....	28	Digital audio performance at Pre-out	32
Sound from only one speaker or one speaker louder than the other.....	28	Warranty.....	32
Very loud, distorted sound when playing a vinyl turntable	28		
Low volume when playing a vinyl turntable	28		
Hum or other noises when playing a vinyl turntable	28		
Operational problems.....	29		
ONE Cast sets to Standby occasionally	29		
Front panel controls are not working	29		
Remote control is not working.....	29		
Unable to set up Wi-Fi using Google Home.....	30		
Identifying if setup has failed.....	30		
Basic checks	30		
Unable to set up Apple AirPlay	30		
ONE Cast does not appear in the AirPlay device list	30		
Audio streaming troubleshooting.....	30		
Audio streaming stops working	30		
Basic checks	30		
Diagnostic system	31		
Error display	31		
Clearing an error	31		
Error types	31		
PSU error.....	31		
Left and Right Output errors.....	31		
Over-temperature error	31		
System error.....	31		

Important! Read before operating this equipment!

CAUTION: The exclamation mark is to draw your attention to important instructions and safety procedures in this manual.



ATTENTION: The lightning flash warns you of the risk of electrical shock presented by components inside this product. Unauthorised personnel must not open this unit.



WARNING: To reduce the risk of electrical shock do not remove any unit covers or panels. There are no user serviceable parts in this product.

WARNING: To reduce the risk of electric shock, do not expose this equipment to rain or moisture.

HEED WARNINGS: All warnings on the product and in the operating instructions should be adhered to.

READ ALL THE INSTRUCTIONS: All the safety and operating instructions should be read before the product is operated.

RETAIN INSTRUCTIONS: The safety and operating instructions should be retained for future reference.

FOLLOW INSTRUCTIONS: All operating and use instructions should be followed.

CLEANING: Unplug this product from the mains before cleaning. Do not use liquid or aerosol cleaners. Use a damp cloth for cleaning.

WATER AND MOISTURE: Do not use this product near water - for example, near a bath tub, wash bowl, kitchen sink, or laundry tub, in a wet basement; or near a swimming pool and the like. The product must not be exposed to dripping or splashing and no objects filled with liquids, such as vases, shall be placed on the product.

HEAT: The product should be situated away from heat sources such as radiators, stoves, or any other products (including amplifiers) that produce heat.

VENTILATION: Slots and openings in the cabinet are provided for ventilation, to ensure reliable operation of the product and to protect it from overheating and these openings must not be blocked or covered. The openings should never be blocked by placing the product on a bed, sofa, rug or similar surface. This product should not be placed in a built-in installation such as a bookcase or rack unless proper ventilation is provided or the manufacturer's instructions have been adhered to.

OBJECT OR LIQUID ENTRY: Never push objects of any kind into this product through openings as they may touch dangerous voltage points or short-out parts that could result in a fire or electric shock.

ACCESSORIES: Do not place this product on an unstable cart, stand, tripod, bracket, or table. The product may fall, causing serious injury to a child or adult, and serious damage to the product. Use only with a cart, stand, tripod, bracket or table recommended by the manufacturer, or sold with the product. Any mounting of the product should follow the manufacturer's instructions, and should use a mounting accessory recommended by the manufacturer.

ATTACHMENTS: Do not use attachments not recommended by the product manufacturer as they may cause hazards.

MOVING THE PRODUCT: A product and cart combination should be moved with care. Sudden stops, excessive force, and uneven surfaces may cause the product and cart to overturn.



POWER SOURCES: This product should be operated only from the type of power source indicated on the marking label. If you are not sure of the type of power supply to your home, consult your product dealer or local power company. For products intended to operate from battery power, or other sources, refer to the operating instructions.

OVERLOADING: Never overload wall outlets, extension cords, or integral convenience receptacles. This can result in an increased risk of fire or electric shock.

POWER CORD PROTECTION: Power supply cords should be routed so that they are not likely to be walked on or pinched by items placed upon or against them, paying particular attention to cords at plugs, convenience receptacles, and the point where they exit from the product.

NAKED FLAMES: No naked flame sources, such as candles, must be placed on this product.

LIGHTNING: For added protection for this product during a lightning storm, or when it is left unattended or unused for long periods of time, unplug it from the wall outlet and disconnect the antenna or cable system. This will prevent damage to the product due to lightning and power-line surges.

BATTERIES: Warning : Batteries shall not be exposed to excessive heat such as sunshine, fire or the like.

CAUTION! POLARISED CONNECTOR (CANADA and USA):

To prevent electrical shock, match wide blade of plug to wide slot, fully insert. Do not alter or remove this plug if it does not fit your mains power socket. Have a suitable socket installed by a competent electrician.

ACCESS TO THE MAINS PLUG: The means to disconnect this product from the mains supply is the mains plug. Ensure that the mains plug is accessible at all times.

WARNING: This appliance must be earthed.



WARNING: To prevent possible hearing damage, do not listen at high volume levels for long periods.

Important! Read before operating this equipment!**Power supply**

The mains supply requirement of your amplifier is marked on a label on the rear panel. Before connecting, check that this voltage is the same as your mains supply.

230V Products: Voltage Range 220V-240V

115V Products: Voltage Range 110V-120V

If you move to an area with a different mains voltage, contact your local Cyrus distributor to have your product converted.

There are no user replaceable fuses in this unit.

Power consumption in Standby

For this product to work with your smart home, it must maintain a wireless network connection during standby mode to transmit voice control function. This enables wake up commands to be sent from the cloud.

To maintain its network connection during standby mode, the unit consumes <2W. To further reduce energy consumption, remove mains from the unit"

Operating environment

This product is designed to be installed and operated in a domestic environment. The ambient temperature when operating should be in the range 0°C - 35°C.

Servicing

Do not attempt to service this product yourself as opening or removing covers may expose you to dangerous voltage or other hazards. Refer all servicing to qualified service personnel.

CONDITIONS REQUIRING SERVICE: Unplug this product from the wall outlet and refer servicing to qualified service personnel:

- When the power supply cord or plug is damaged.
- If liquid has been spilled, or objects have fallen into the product.
- If the product has been exposed to rain or water.
- If the product has been dropped or damaged in any way.
- If the product does not operate normally by following the operating instructions. (Adjust only those controls that are covered by the operating instructions. Improper adjustment of other controls may result in damage requiring extensive work by a qualified technician to restore the product to its normal operation).
- When the product exhibits a distinct change in performance.

REPLACEMENT PARTS: When replacement parts are required, be sure the service technician has used replacements specified by the manufacturer or have the same characteristics as the original part. Unauthorised substitutions may result in fire, electric shock, or other hazards.

SAFETY CHECK: Upon completion of any service or repairs to this product, ask the service technician to perform safety checks to determine that the product is in proper operating condition.

Product service centres

For product service or technical advice, contact only authorised Cyrus service centres. Contact details for Cyrus distributors may be found on the Cyrus website at www.cyrusaudio.com.

Important! Read before operating this equipment!**WEEE**

This logo means that this product is not to be disposed of with your household waste. This product should be handed over to a designated collection point to be recycled. Your cooperation in the correct disposal of this product will contribute to the effective usage of natural resources. For more information on collection points, contact your disposal service or City Hall.

**Legal notices**

The **Bluetooth**[®] word mark and logos are registered trademarks owned by **Bluetooth** SIG, Inc. and any use of such marks by Cyrus is under license. Other trademarks and trade names are those of their respective owners.

Google, Android, Google Play, YouTube and other marks are trademarks of Google LLC.

Amazon, Echo, Alexa and all related logos are trademarks of Amazon.com, Inc. or its affiliates.

Use of the Works with Apple badge means that an accessory has been designed to work specifically with the technology identified in the badge and has been certified by the developer to meet Apple performance standards.

Apple, AirPlay, Apple TV, Apple Watch, iPad, iPad Air, iPad Pro, iPhone, and Lightning are trademarks of Apple Inc., registered in the U.S. and other countries.

Important! Read before operating this equipment!**FCC NOTICE***

NOTE: This equipment has been tested and found to comply with the limits for a Class B digital device, pursuant to Part 15 of the FCC rules. These limits are designed to provide reasonable protection against harmful interference in a residential installation. This equipment generates, uses and can radiate radio frequency energy and, if not installed and used in accordance with the instructions, may cause harmful interference to radio communications. However, there is no guarantee that interference will not occur in a particular installation. If this equipment does cause harmful interference to radio or television reception, which can be determined by turning the equipment off and on, the user is encouraged to try and correct the interference by one or more of the following measures:

- Reorient or relocate the receiving antenna.
- Increase the separation between the equipment and receiver.
- Connect the equipment into an outlet on a circuit different from that to which the receiver is connected.
- Consult the dealer or an experienced radio/TV technician for help.

Any changes or modifications not expressly approved by the manufacturer could void the user's authority to operate the equipment.

*115V products

Introduction

Welcome to the world of Cyrus!

Congratulations on your choice of Cyrus Hi-fi products. Our state-of-the-art design technology and outstanding quality of manufacture has won countless awards around the world. We are confident that you will derive great pleasure from owning a product from one of the most recognised and respected manufacturers of hi-fi equipment.

Now is a good time to register your new Cyrus product. To register, visit www.cyrusaudio.com/support and click the 'Register your product' link.

Registering your product will help speed up turnaround times in the unlikely event that you have any servicing or repair needs in the future. You can also sign up to be the first to hear about new Cyrus products and services.

Please read these instructions carefully before commencing installation. They provide full guidance to help you install your amplifier safely and correctly.

Preparations for Installation

Before installing your Cyrus amplifier check that the following items are included in the accessory box.

- Power cable appropriate for your region.
NOTE: Some products may have more than one power cable included.
- Remote control with batteries
- Quick-start guide

After removing these items, please retain the packaging.

Install the amplifier in a well ventilated location away from sources of high temperature, dust or humidity. Never stand the amplifier under another unit or on any surface likely to obstruct its cooling or ventilation.

What does ONE Cast do?

The ONE Cast amplifier is a very versatile, wi-fi enabled amplifier for smart home audio systems.

For the simplest hi-fi system, just connect a pair of speakers to your ONE Cast and wirelessly feed the music from your favourite apps* directly to the ONE Cast, making it available in hi-fi quality.

*Apps compatible with Google Cast such as Spotify, Tidal, Qobuz and Deezer will be able to connect to the ONE Cast.

With ONE Cast you can -

- Use mobile devices to play music or movie soundtracks in very high quality over a wi-fi link or via Bluetooth audio.
- ONE Cast is compatible with Google Assistant, Apple AirPlay 2 and Amazon Alexa systems so will integrate fully with any or all of these devices in your smart-home. You can easily set up a multi-room system that includes one or more ONE Cast amplifiers.
- Voice control is possible via Google Home, Apple HomePod or Amazon Alexa devices.
- ONE Cast also includes connections for just about every type of wired audio-visual component such as a Games console, HDMI (ARC) sound feed from a TV, a DVD player, USB audio from a laptop, a vinyl turntable and an analogue line audio source.

Installation

Back panel features

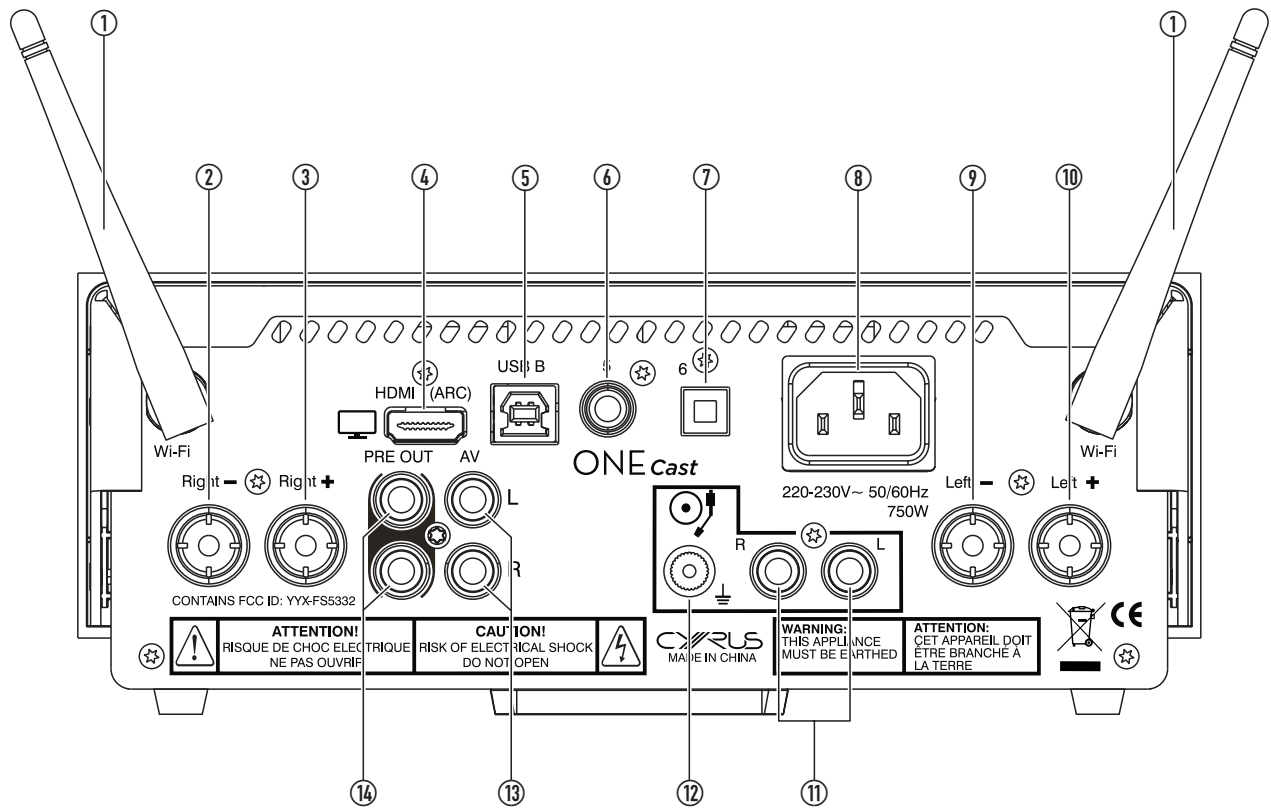

- | | |
|---|---|
| <ul style="list-style-type: none"> 1. Wi-Fi aerials 2. Right - speaker output 3. Right + speaker output 4. HDMI (ARC) input 5. USB Input 6. Digital coaxial input 7. Optical input | <ul style="list-style-type: none"> 8. AC power inlet 9. Left - speaker output 10. Left + speaker output 11. Phono MM input 12. Phono ground screw 13. AV input 14. Preamp output |
|---|---|

Installation

Connections

Important – read before connecting anything

- Always disconnect all system components from the mains before changing any connections. Connect the mains when everything is hooked up.

When connecting sources avoid the use of long interconnects which may degrade sound quality. The maximum length advised is 3m.

What can I connect?

You can play sound from **Bluetooth** sources such as a phone or a computer.

You can connect a vinyl turntable. It must have a Moving Magnet cartridge. Moving Coil cartridges are not compatible.

You can connect two digital audio sources. Both cable and optical connection are available.

You can connect a TV equipped with HDMI (ARC) audio return channel.



You can play music from a computer using the USB input.

You can connect a line analogue line source (such as a CD or DVD players, a TV or satellite box).

Connect a turntable

- NOTE: Some turntables include preamplifiers and may have high level output. If these have switchable 'PHONO' and 'LINE' settings then the switch must be set to the 'PHONO' position before connecting to the phono input. If your turntable only provides a line level output then this must be connected to the AV input of the ONE Cast, described in the section 'Connect analogue line audio'.

The turntable will have a cable with two plugs, and often a thin ground wire with a tag.

- Connect the plugs to the  sockets on the back panel. Connect the white plug to the left socket and the red plug to the right socket.
- Unscrew the ground  terminal then fasten the ground wire under the terminal.

Connect digital audio

If you have digital audio sources you can connect them to Input 5 (cable) or Input 6 (optical).

- For wired digital sources, connect a digital phono interconnect (not supplied) from the output of the source to Input 5.
- For optical digital sources, connect a Toslink optical interconnect (not supplied) from the output of the source to Input 6.

Connect HDMI (ARC)

Check that the TV includes an HDMI outlet marked HDMI (ARC).

- The outlet must be marked to include ARC (audio return channel). A standard HDMI connection will not provide digital sound to the ONE Cast.

- Connect an HDMI cable from the HDMI (ARC) connector on the TV to the HDMI (ARC) connector on the ONE Cast.

Connect USB audio

If you connect a computer to the USB audio port you can play all audio from the computer through your amplifier.

- Connect a USB A to USB B cable (not supplied) between a free USB port on the computer and the USB B input.

Connect analogue line audio

If you have a line audio source you can connect it to the AV analogue input.

- Connect a stereo phono interconnect (not supplied) from the outputs of the source to the input on the back panel.
- Connect the white plug to the left socket and the red plug to the right socket.

If the source has surround-sound (DVD player etc), check that the source is set to work in two channel stereo mode.

Connect speakers

The amplifier and speakers have red and black speaker terminals. Make sure the red terminal on the amplifier connects to the red terminal on the speaker (and black to black).

- Speaker cables will have a polarity indicator. This is usually a stripe or rib on the wire to show the red connection.
- Connect the striped wire to the red terminal at each end, then connect the other wire to the black terminals.

Make sure the left speaker is connected to the left terminals at the amplifier (and right to the right).

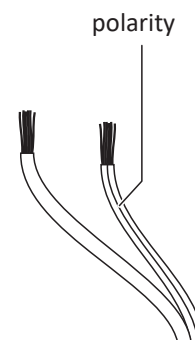

Connect mains power

When you have finished all other connections, connect mains power.

- Connect the socket on the power cable to the power inlet on the back panel of the amplifier. Now connect the cable to a mains outlet.

NOTE: The means to disconnect this product from the mains supply is the mains plug. Ensure that the mains plug is accessible at all times.

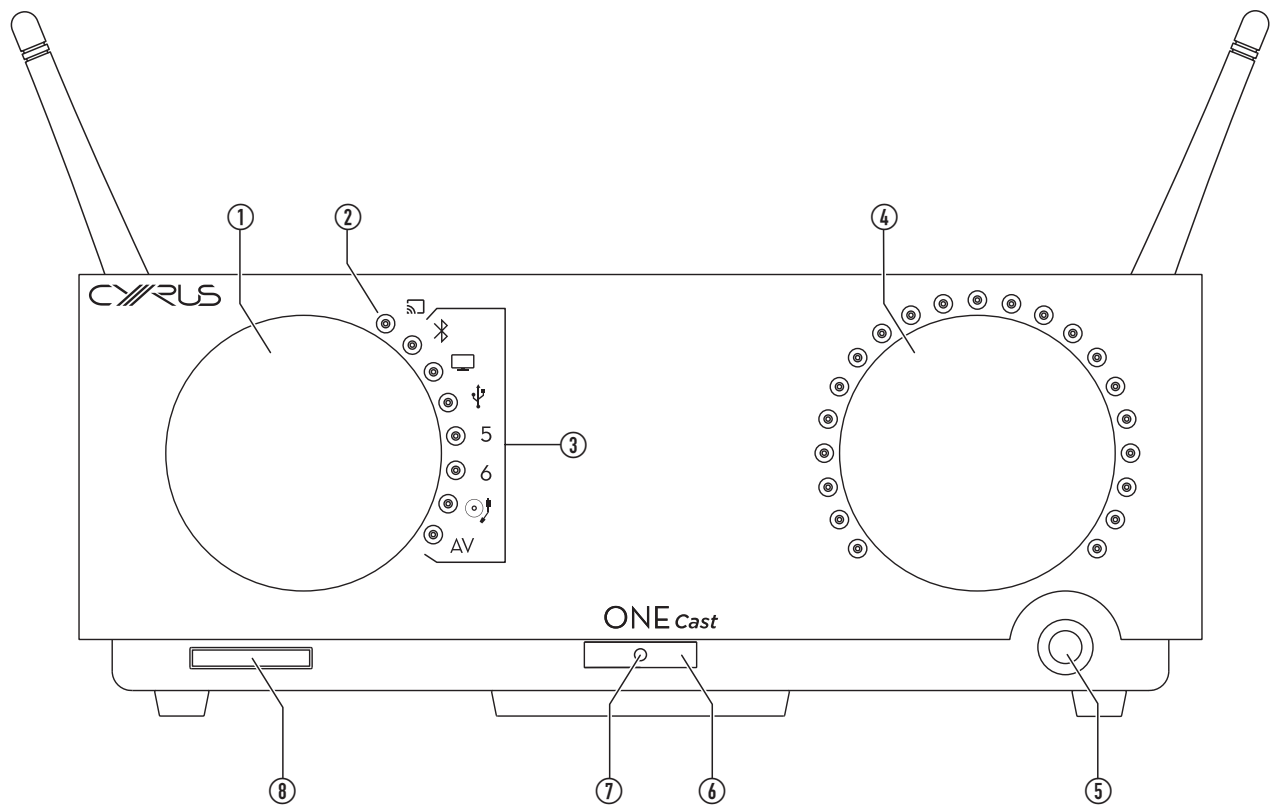
Controls and features**Front panel features**

1. Source selector
2. Status indicator
3. Input indicators
4. Volume control
5. Headphone socket
6. Remote control window
7. Standby indicator (behind window)
8. Standby button

Controls and features

Front panel

Standby

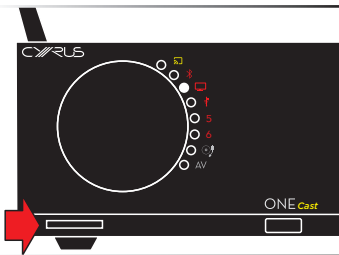

Standby is controlled by the Standby button on the front panel or  on the remote control.

- Press the button to switch the amplifier on. Press again to switch the amplifier off.

When the amplifier is switched on the front panel indicators for source and volume level will light.

Standby indicator

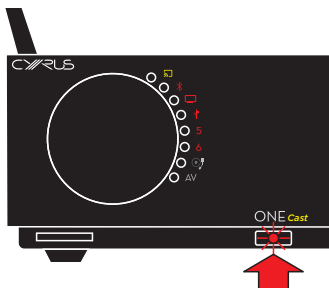

The Standby indicator is located at the bottom of the front panel.



The indicator will light when ONE Cast is set to Standby.

- ! If Internet connection is interrupted during Standby or if the ONE Cast requires wi-fi setup, the Standby indicator will flash.

Auto standby

If no sound has played for 20 minutes the ONE Cast will automatically set to Standby to conserve power.

Selecting an input source

- Turn the source control to select a source.
- From the remote control, press  or  to step through the sources.

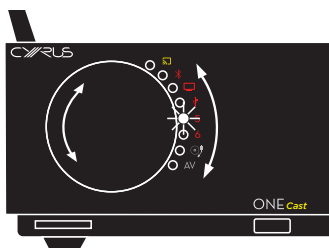

The source indicator will change to show the source selected.

Status indicator 

- ! NOTE: the  indicator is a multi-function status indicator, not a selectable source. When playing music from a mobile app, the source is selected automatically.

By changing colour or flashing, this indicator will display status of setup, wireless music play or if there is any kind of operational problem.

Volume

- Turn the volume control clockwise to increase the volume or anti-clockwise to reduce the volume.

The volume indicators will show the volume level.

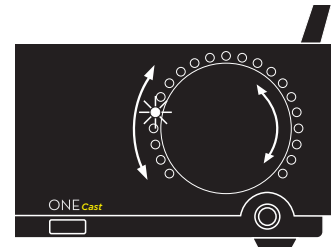

Listening through headphones

The headphone socket is a standard 1/4" (6.35mm) stereo jack on the front panel. Converters are readily available if you want to use headphones with a smaller (3.5mm) jack.

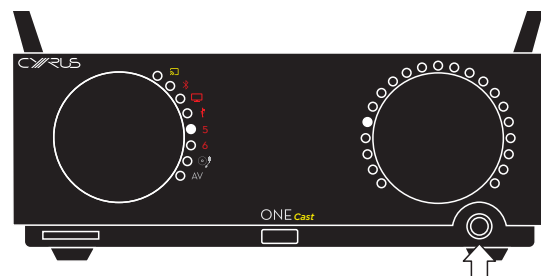

- Plug the headphones into the front panel headphone jack.

The speakers will switch off and music will play through the headphones.

If you connect headphones after listening to speakers at a high volume level, the volume will be reduced to a safe level.

Warning: Excessive sound pressure from earphones and headphones can cause hearing loss.

Disconnecting headphones

- To return to speaker listening, unplug the headphones from the front panel jack.

The sound will play through the speakers.

If you disconnect headphones after listening to them at a high volume level, the volume will be reduced to a safe level before returning to speaker operation.

Controls and features

Remote control

Remote control features

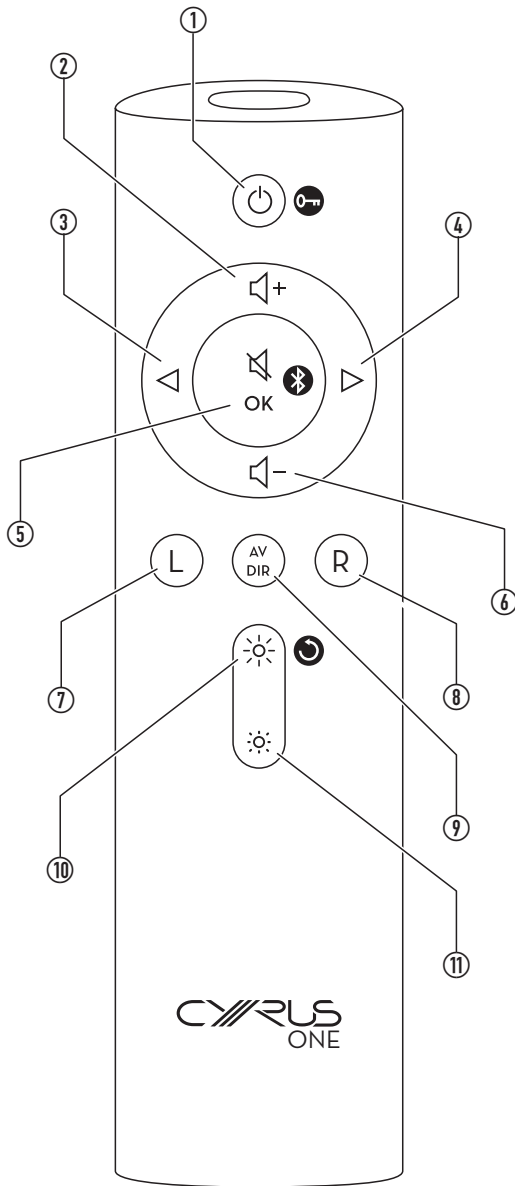

1. Standby
Control lock (see page 11)
2. Volume up
3. Previous input
4. Next input
5. Mute/OK/Clear Bluetooth memory
6. Volume down
7. Balance left
8. Balance right
9. AV direct setting
10. Increase display brightness
Reset (see page 25)
11. Reduce display brightness

Fitting/Replacing the remote control batteries

- Slide the battery cover off the remote control in the direction shown.
- Lift the cover off the remote control.

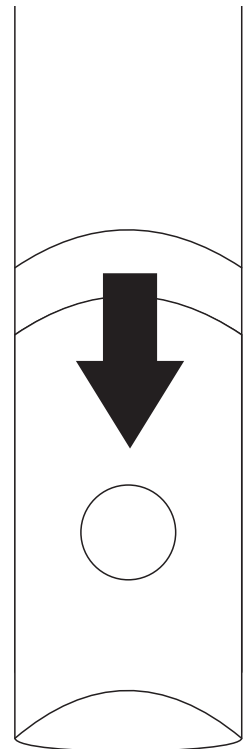

- Remove the expired batteries (if necessary).
- Fit new batteries observing polarity as shown.

When replacing the battery, use only the same AAA type.

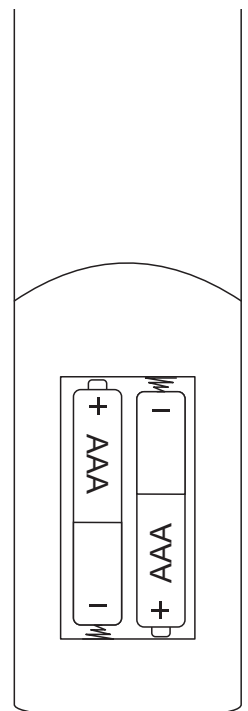

Alkaline batteries are recommended. Other types of battery may leak and cause damage.

Battery disposal

Dispose of used batteries with regard to the recycling regulations in your area. Do NOT short circuit batteries or throw them into water, the general rubbish or in a fire.

Controls and features

Remote control

Standby

- Press  to switch on or set to Standby.
The source and volume display indicators will light when switched on.
The standby indicator will light when set to Standby.

Control lock

The control lock function will lock all front panel controls including Standby. This may be useful during a party or to prevent accidental operation by children.

-  **NOTE:** The remote control is not locked by control lock and control functions available from a mobile will continue to operate as normal.

Locking the controls

- Press and hold  for 5 seconds to start control lock.

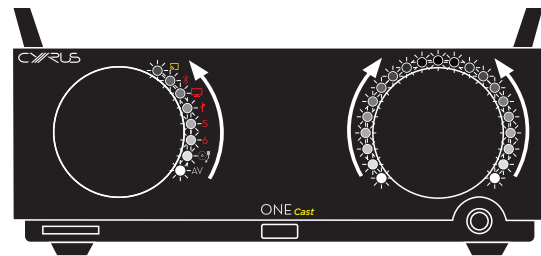

The input and volume displays will strobe upwards.

- To confirm lock, press OK within 5 seconds.
- The controls will be locked.

If no action is taken within 5 seconds the strobe display will stop and control lock will not be set.

Unlocking the controls

- When the controls are locked, press and hold  for 5 seconds to start control unlock.

The input and volume displays will strobe downwards.

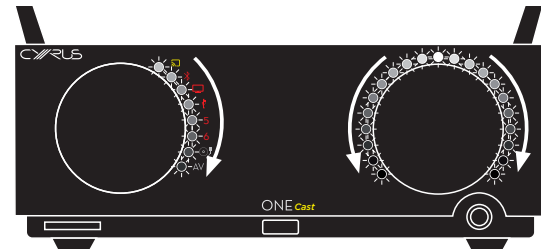

- To confirm unlock, press OK within 5 seconds.
- The controls will be unlocked and return to normal operation.

If no action is taken within 5 seconds the strobe display will stop and control lock will remain set.

Controls and features

Remote control

Volume

- From the remote control, press $\text{⏮}+$ to increase the volume or $\text{⏭}-$ to reduce the volume.

The volume indicators will show the volume level.

Mute

- Press ⏸ on the remote control to mute the sound.

The sound will fade to minimum.

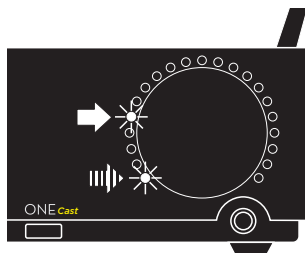

The volume display will fade to minimum. The current volume display will remain lit and the minimum light will flash to indicate mute.

Balance

Balance control will move the stereo soundstage if you are not able to sit in the ideal listening position between the speakers.

- Press L repeatedly to move the stereo soundstage to the left in 1dB steps.
- Press R repeatedly to move the stereo soundstage to the right in 1dB steps.

The volume display will change to show the balance setting.

The maximum and minimum volume indicators will light to indicate balance setting is being displayed. A third indicator shows the balance position.

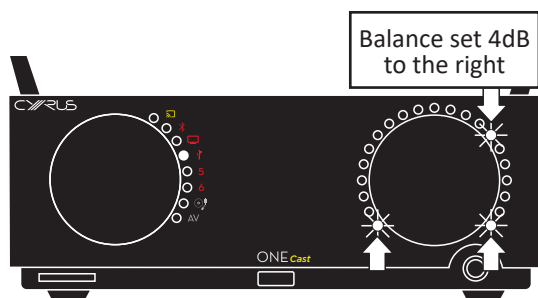
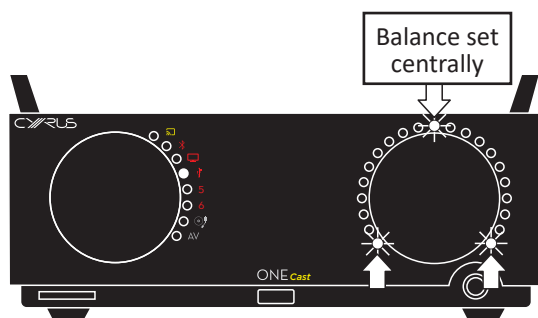

The balance setting will be saved and balance mode will exit when no adjustment has been made for 3 seconds.

Input select

- Press ◀ or ▶ to step through the input sources available.

Indicator brightness

The brightness of the front panel indicators is adjustable in 6 steps.

- Press ☀ to increase the brightness of the front panel indicators.
- Press ☾ to decrease the brightness of the front panel indicators.

Setting up Wi-Fi

Choosing a Wi-Fi setup method

Options

There are two wi-fi setup options -

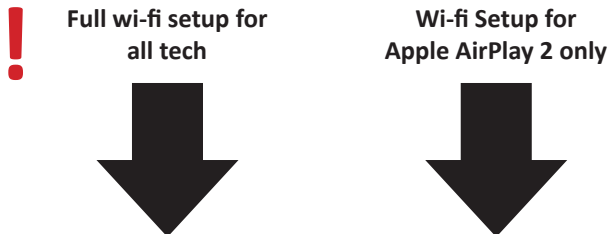

Full wi-fi setup will enable Google Home casting, Apple AirPlay 2 and Amazon Alexa.

If you only plan to play audio from Apple mobile devices via AirPlay 2, then this option is quicker and simpler.

NOTE: If you later want to change your setup, you can factory reset the unit and begin setup again.

What do I need?

The minimum requirement is -

- A wireless network that has Internet connection and a mobile phone or tablet, connected to that network.
- A pair of speakers connected to the ONE Cast.
Refer to page 7 for instructions to connect speakers.
- In addition, a Google (gmail) account will be required for the full wi-fi setup option.

Will the ONE Cast remember my Wi-Fi settings?

Yes, the ONE Cast will remember wi-fi settings. It will remain connected in Standby and visible to mobile devices for casting. It will always reconnect to the last wireless network if power has been lost and re-connected.

Can I change the wireless settings?

Yes. If you want to move the ONE Cast to another network you can clear all settings by following the simple factory reset procedure (see page 25).

Broadband usage

- ! • Whichever technology you choose, streaming music to a ONE Cast via Wi-Fi will use internet bandwidth from your home broadband. Make sure that your broadband connection has enough capacity for the volume of data you will use.

An unlimited broadband supply is highly recommended to avoid exceeding capacity limits and incurring additional costs. Contact your broadband provider if you are in any doubts about the capacity of your broadband connection.

Setting up Wi-Fi

Full wi-fi setup

Preparation

- Check if you have the Google Home app installed on your mobile.

If not, you can download and install it from the Google Play store (Android mobiles) or from the Apple store (iOS mobiles).



Google Home app at the Google Play store



Google Home app at the Apple store

- Check that your mobile device is connected to the wireless network where you will add the ONE Cast.

The ONE Cast will need to receive a good Wi-Fi signal from the wireless router that is the source of your wireless network.

- Check that Bluetooth communication is switched on at the mobile.

There is no requirement to pair the mobile to the ONE Cast, but Google Home will use Bluetooth communication during the setup process.

- Check that the ONE Cast is located within range of this router.

As a general guide you can hold your mobile device at the location of the ONE Cast to check signal strength. If signal strength is low you may need to arrange for a WiFi repeater to boost the signal.

- Connect a pair of speakers to the ONE Cast (refer to page 7).

It's OK to connect other sources etc, but speakers must be connected to play a tone during Google Home setup.

- Connect power to the ONE Cast.

Setup

- Press the Standby button to switch on the ONE Cast.

The ONE Cast will switch on.

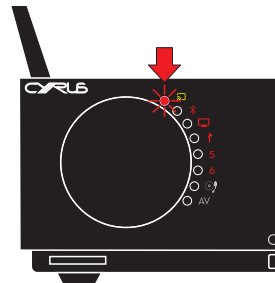

If the unit has just been connected to the mains, the Status indicator will flash red quickly (initialising). This should take about 25 seconds.

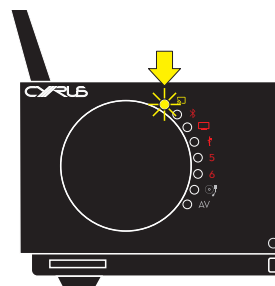

Once initialisation is complete, the Status indicator will flash yellow slowly (discoverable). You can now set up the ONE Cast.

- Launch the Google Home app.
- Follow the instructions within the app to add the ONE Cast to your chosen Home.

You can add the ONE Cast to an existing Google Home or create a new Google Home for this and other devices.

During setup the Status indicator will flash yellow quickly.

Completing setup

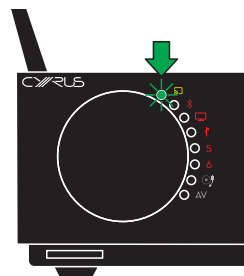

At the completion of setup the Status indicator will stop flashing and change to green.

This confirms successful connection to your Wi-Fi network and indicates ONE Cast is 'ready to cast'.

After setup, the Google Home app will recommend an audio test. You can run this test to confirm that setup has been completed successfully.

Setup failure

In the unlikely event that setup fails, this will be shown on the screen of the mobile. Re-try setup and if this also fails, refer to the Troubleshooting section on page 30.



If you encounter any problems in setting up ONE Cast, the Cyrus website includes a full step by step guide with screenshot illustrations from a mobile.

Setting up Wi-Fi

AirPlay wi-fi setup

Preparation

NOTE: If this setup method is used it will only be possible to play audio on the ONE Cast from an Apple mobile device. It will not be possible to play audio on the ONE Cast using the Google Cast function or Amazon Alexa.

No special app is needed to set up for AirPlay use with Apple mobile devices.

- Check that your Apple mobile device has Wi-Fi switched on and that it is connected to the wireless network where you will add the ONE Cast.

The ONE Cast will need to receive a good Wi-Fi signal from the wireless router that is the source of your wireless network.

- Check that the ONE Cast is located within range of this router.

As a general guide you can hold your mobile device at the location of the ONE Cast to check signal strength. If signal strength is low you may need to arrange for a WiFi repeater to boost the signal.

- Connect power to the ONE Cast.

Factory reset before setup

- Factory reset is always necessary before proceeding with AirPlay setup. The first few steps will complete this process.

- Press the Standby button to switch on the ONE Cast.

The ONE Cast will switch on.

- Within 10 seconds, turn the volume control anti-clockwise continually, at least three rotations until control display changes to display the firmware version.

Following the version display all front panel indicators will flash twice to confirm settings have been factory reset.

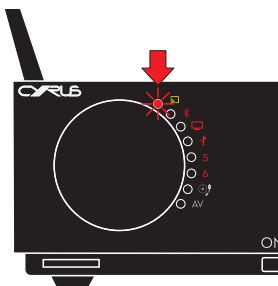

The Status indicator will flash red quickly after factory reset (initialising). This should take about 25 seconds.

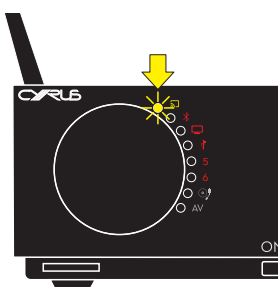

Once initialisation is complete, the Status indicator will flash yellow slowly (discoverable). You can now set up the ONE Cast.

Setup

- Open Wi-Fi settings on your mobile.
- Below the list of networks is an option to set up a new AirPlay speaker.

The ONE Cast should be shown in the list in the format CyrusONECastxxxx where xxxx is the last 4 digits of the MAC address.

- Select the ONE Cast option.
- Follow the prompts on your mobile to setup the ONE Cast as an AirPlay speaker.

During connection the status indicator will flash yellow quickly.

Completing setup

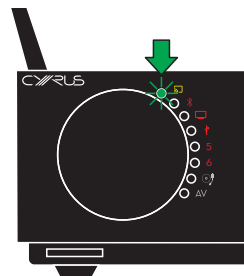

At the completion of setup the Status indicator will stop flashing and change to green.

Refer now to the Operation section on page 19 for more instructions to play audio via AirPlay from your mobile device.

Setup failure

In the unlikely event that setup fails, this will be shown on the screen of the mobile. Re-try setup and if this also fails, refer to the Troubleshooting section on page 30.

Setting up Wi-Fi

Setting up to use with Amazon Alexa

Initial Wi-Fi setup

The ONE Cast must first be connected to Wi-Fi using the full setup method.

If you have not already completed a full wi-fi setup, refer to page 14 and follow the instructions to connect your ONE Cast to your Wi-Fi network.

Nuvola skill and UNDOK app

- | The Nuvola skill links compatible 'Works with Alexa' smart speakers with the Alexa ecosystem to enable Alexa enabled devices such as an Echo or Echo Dot to control your ONE Cast. The Nuvola account and associated UNDOK app are provided by our partner Frontier who enable this technology.

The Nuvola skill and UNDOK app are only used during set up of ONE Cast. Once setup is complete the ONE Cast will remain connected to your Wi-Fi network as part of an Alexa system without the need to run the UNDOK app again.

Installing the Alexa app

- You may already have the Alexa app installed on your mobile if you have a system of Alexa devices. If not, search for it at the app store and install it now.
- Open the app and sign in to your Amazon account.

If you don't have an Amazon account you can create one.

Register the Nuvola skill in the Alexa app

- From the home screen of the Alexa app, tap 'Devices'.
The Devices page will open.
- From the Devices page, tap 'Your Smart Home Skills'.
- If this is the first time you used the app you will need to tap 'Enable Smart Home Skills' to open the Smart Home page.
The Smart Home page will open.
- Tap search and enter Nuvola in the search bar.
The Nuvola Smart Home skill should be shown.
- Select the Nuvola skill and enable it on the next screen.
- Register a Nuvola account when prompted.
- Make a note of the login details you used.
When the account is set up you will return to the Alexa app.

Installing the UNDOK app

- The UNDOK app
- Follow this link or search the Google Play store (Android mobiles) or the Apple store (iOS mobiles) to find the UNDOK app.



UNDOK app at the Google Play store



UNDOK app at the Apple store

- Install the app.
- Launch the app.
- Tap the settings icon.
- Tap 'Frontier Nuvola Account'.
- Follow the prompts to Add a Device.
If your ONE Cast is already connected to wi-fi you will see it listed in the app.
- Add the ONE Cast.
- Follow the prompts to associate the ONE Cast with your Frontier Nuvola account.
Setup is now complete.

NOTE: There will be no need to use the UNDOK app again unless the ONE Cast is factory reset for any reason.

Operation

Using Google Cast to play music

How does casting work?

You can 'cast' any music, podcasts or other audio content that is playing on enabled apps on your mobile phone or tablet to the ONE Cast.

When casting, the audio stream is transferred from the mobile to stream directly to the ONE Cast via its Wi-Fi connection.

The mobile app continues to be used to control play, pause, track selection and other commands for the app while volume can be controlled from either the ONE Cast front panel or from the mobile.

Which apps are cast enabled

You can cast music to ONE Cast from any Chromecast enabled app. Most of the popular music apps for Apple or Android mobiles include a cast option.

If you want to find more apps to use with your ONE Cast, search the Internet for 'Chromecast enabled apps'.

Open a cast-enabled app on your mobile and play the music you want to cast to the ONE Cast.

Before first use, check Wi-Fi setup

A full Wi-Fi setup must be completed before it is possible to cast music to the ONE Cast.

- Switch on the ONE Cast.
- Check that the Status indicator is green to confirm Wi-Fi connection.

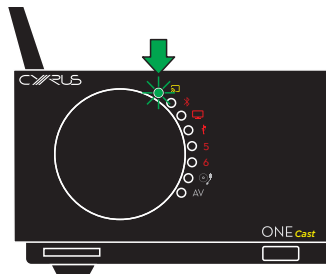

If the Status indicator is flashing yellow, setup will be required or there may be a problem with your network. Refer to the 'Full Wi-Fi setup' section for instructions to connect ONE Cast to your network.

Playing music

- Select a music app from your mobile.
- From the app, select the option to cast to other devices. *This may be the Cast logo  or a link to play through other devices or speakers.* *The ONE Cast will be listed with any other Cast speakers connected to your network.*
- Select the ONE Cast. *After a short delay, the Status indicator will change to white.* *Music playing from the app will now play through the ONE Cast.*

Volume control

When casting, the ONE Cast volume level may be controlled from your mobile, from the ONE Cast front panel or from the remote control.

NOTE: Some mobile volume controls have a limited number of steps and it will be very easy to set an extremely high volume level. For this reason, controlling volume from the ONE Cast front panel, remote control or from within the Google Home app on your mobile is recommended.

Play, pause, track selection etc

All playback functions such as play, pause, track selection, repeat, shuffle are controlled from the app on your mobile.

Casting from Standby

The ONE Cast is always ready to play wireless audio, even when in Standby and will appear in the list of available casting speakers on your mobile whilst it is set to Standby.

If you select the ONE Cast it will automatically switch on and start to play.

Dynamic range setting

The Google Home app may include a setting for 'Full dynamic range'. If available, this should always be set 'On'.

- Open the app home page to display the Google Home system devices.
- Tap the name for the ONE Cast.
- Tap the settings icon for this device. *The Full Dynamic Range setting will appear on this page.*
- Ensure that this setting is 'On' for best performance from a ONE Cast.

NOTE: If the setting is unavailable there is no need to take any action.

Operation

Using Google Cast to play music

Voice control of a ONE Cast from a mobile

Voice commands can be made directly from an Android mobile or an iOS mobile running the Google Home app.

NOTE: When making voice commands to an iOS mobile running the Google Home app it will be necessary to tap the microphone icon on-screen first.

If you haven't used voice commands before to play music then check your mobile is set up correctly by using voice commands to play music from your mobile.

You may find your preferred music service provider will need to be enabled to work with Google Assistant.

Once you are set up to use voice commands to play music on your mobile, try playing the music on your ONE Cast using voice commands.

Commands are generally prefixed by the phrases 'Hey Google' or 'OK Google'.

Typical voice commands could be -

- 'Hey Google, play music on Living Room speaker'
- 'Hey Google, play my party playlist from Spotify on Living Room speaker'
- 'Hey Google, set the volume of Living Room speaker to 30%'
- 'Hey Google, stop playing on the Living Room speaker'.

In these examples, Living Room is the name given to the ONE Cast during setup.

Voice control of a ONE Cast from other Google Home devices

Voice commands can also be made via smart speakers and other devices enabled with the Google Assistant that are connected to your Google Home.

- ! Ensure that all the devices including ONE Cast amplifiers are part of the same Google Home group and assigned to the same Google account. If not, the ONE Cast amplifiers may appear for casting, but will not be available for voice control.

Setting up speaker groups

If you have multiple ONE Cast amplifiers you can group them together within Google Home, then cast music to all amplifiers in that group simultaneously.

Operation

Playing music via Apple AirPlay

How does ONE Cast work in an Apple AirPlay system?

Once set up, the ONE Cast will be available as an AirPlay speaker to Apple devices.

AirPlay works by setting up a direct link from your mobile to the ONE Cast through your Wi-Fi network. Your mobile can then send the sound playing from a mobile app to the ONE Cast and other AirPlay speakers.

Preparation

- Ensure that the ONE Cast is set up correctly and connected to your network.

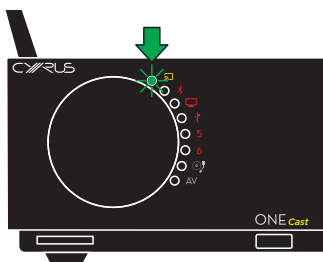

The Status indicator must be green.

Playing music

- Select a music app from your Apple mobile.
- From the app, select the option for AirPlay.
This may be the AirPlay logo  or a link to play through other devices or speakers.
The ONE Cast will be listed with any other AirPlay speakers connected to your network.
- Select the ONE Cast.

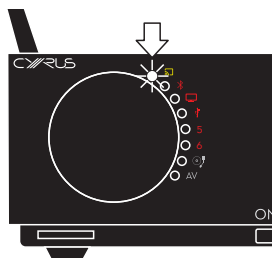

After a short delay, the Status indicator will change to white.

Music playing from the app will now play through the ONE Cast.

Volume control

When playing music via AirPlay, the ONE Cast volume level may be controlled from your mobile, from the ONE Cast front panel or from the remote control.

NOTE: Some mobile volume controls have a limited number of steps and it will be very easy to set an extremely high volume level. For this reason, controlling volume from the ONE Cast front panel, remote control or from within the Google Home app on your mobile is recommended.

Play, pause, track selection etc

All playback functions such as play, pause, track selection, repeat, shuffle are controlled from the app on your mobile.

AirPlay from Standby

The ONE Cast is always ready to stream wireless audio, even when in Standby and will appear in the list of available AirPlay speakers on your mobile whilst it is set to Standby.

If you select the ONE Cast it will automatically switch on and start to play.

Operation

Voice commands using Siri

You can use voice commands to your Apple mobile or HomePod etc to control your ONE Cast.

Using voice commands with an AirPlay system

Additional setup stages are necessary if you want to control your ONE Cast with voice commands from an Apple mobile, HomePod etc. It will be necessary to add the ONE Cast to an Apple Home system.

- Ensure that the ONE Cast has been connected to your Wi-Fi network.
 - Check that you can play music to your ONE Cast via AirPlay.
 - *You will not be able to add your ONE Cast to your Apple Home if you cannot play music via AirPlay.*
- Open the Apple Home app and add the ONE Cast to your Apple Home.
 - *Once the ONE Cast has been added to your Apple Home you can rename it with a friendly name for voice commands if necessary.*

Voice commands can now be made directly via Siri.

- If you haven't used voice commands before to play music then check your mobile is set up correctly by using voice commands to Siri to play music from your mobile.

Once you are set up to use voice commands to play music on your mobile, try playing the music on your ONE Cast using voice commands.

Commands are generally prefixed by the phrase 'Hey Siri'.

Typical voice commands to play music on your ONE Cast could be -

- 'Hey Siri, play music on Living Room speaker'
- 'Hey Siri, set the volume of Living Room speaker to 30%'
- 'Hey Siri, stop playing on the Living Room speaker'

In these examples, Living Room is the name given to the ONE Cast during setup.

Multiple speaker systems

One or more ONE Cast amplifiers can be included in your home with your other AirPlay 2 compatible speakers, smart TVs and other devices using the Apple Home app.

The ONE Cast can be added to any room in the Apple Home app as an AirPlay 2 device.

Operation

Using Amazon Alexa to play music

Initial setup checks

-  Check that you have completed the following -
 - Completed a full Wi-Fi setup (page 14).
 - Completed setup to use with Amazon Alexa (page 16).

Preparation

- Ensure that the ONE Cast is set up correctly and connected to your network.

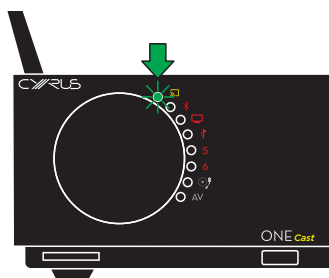

The Status indicator must be green.

Playing music

- Open the Alexa app.
- From the app, tap the 'Play' option and follow the prompts to select the music you want to listen to.

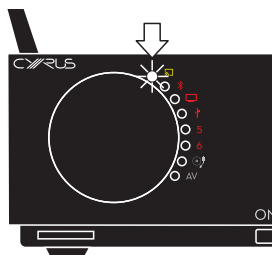

After a short delay, the Status indicator will change to white.

Music playing from the app will now play through the ONE Cast.

Volume control

When playing music, the ONE Cast volume level may be controlled from your mobile, from the ONE Cast front panel or from the remote control.

NOTE: Mobile volume controls have a limited number of steps and it will be very easy to set an extremely high volume level. For this reason, controlling volume from the ONE Cast front panel or remote control is recommended.

Play, pause, track selection etc

All playback functions such as play, pause, track selection, repeat, shuffle are controlled from the app on your mobile.

Alexa commands from Standby

The ONE Cast is always ready to stream wireless audio, even when in Standby and will appear in the list of available devices on your mobile whilst it is set to Standby.

If you select the ONE Cast it will automatically switch on and start to play.

Voice control using Alexa

Voice commands can be made directly via Alexa.

- If you haven't used voice commands before to play music then check your mobile is set up correctly by using voice commands to Alexa to play music from your mobile and/or other Alexa system devices.

Once you are set up to use voice commands to play music on your mobile, try playing the music on your ONE Cast using voice commands.

Commands are generally prefixed by the phrase 'Alexa'.

Typical voice commands could be -

- 'Alexa, play music on Living Room speaker'
- 'Alexa, set the volume of Living Room speaker to 2'.
- 'Alexa, stop playing on the Living Room speaker'.

In these examples, Living Room is the name given to the ONE Cast during setup.

Multi-room audio

The ONE Cast does not currently support multi-room audio as part of an Alexa system.

Operation

Bluetooth audio

First time use/pairing

! NOTE: If possible, complete a full ONE Cast Wi-Fi setup before pairing a **Bluetooth** source. After a full Wi-Fi setup the Wi-Fi name of the ONE Cast will also be the **Bluetooth** name.

- Set the source selector to the **⌘** position.
A **Bluetooth** scan will start.
If no previously connected Bluetooth mobiles can be re-connected, the Bluetooth indicator will flash.
- Activate **Bluetooth** mode on the mobile.
The mobile may now show a list of available Bluetooth sources. If not you may need to search for available devices.
If you have completed a full Wi-Fi setup, the ONE Cast will be identified by its Wi-Fi name.
If you have not set up Wi-Fi or if you have set up Wi-Fi for AirPlay only, the ONE Cast will be identified as 'CyrusONECastxxxx', where 'xxxx' is the last four digits of the MAC address.
- Choose to pair with this.
Your mobile will now pair with the ONE Cast and connect.
When connected, the Bluetooth indicator will stop flashing and there will be a short whistle sound through the speakers.

Disconnecting a mobile

- Use the **Bluetooth** menu of the mobile to disconnect from the ONE Cast.
When a mobile disconnects the Bluetooth indicator will flash and there will be a violin sound through the speakers.

NOTE: A connected mobile will automatically be disconnected when another input is selected.

Re-connecting

Most mobiles will re-connect when next in range, others may require manual connection. If several mobiles have been paired to the ONE Cast, the most recently connected mobile will connect as a priority.

Clearing the Bluetooth memory

The ONE Cast memory for stored **Bluetooth** mobiles can be cleared if required.

- Set the source selector to the **⌘** position.
- Press and hold the **⏪/OK/⏩** button on the remote control for 5 seconds.
The Bluetooth memory will be cleared.
A double violin sound will confirm.

NOTE: The **Bluetooth** memory will also be cleared after a Factory Reset.

Playing music

Once your mobile is connected you can select the music you want to play from the mobile and set the volume level etc. at the amplifier.

When multiple mobiles are paired, the mobile that is playing will generally hold the **Bluetooth** channel until play stops. Some mobiles, particularly computers, may hold the **Bluetooth** channel after play stops. In this case the mobile will need to be disconnected before playing another.

Volume control

When playing **Bluetooth** audio, the volume controls on both the mobile and the ONE Cast may be used to control the volume level from the speakers. The ONE Cast volume control or remote control is recommended as this will allow much finer control of volume level.

Operation

Playing connected sources

Playing a vinyl turntable

- Set the source selector to the  position.
- Start the record playing.

Playing an analogue source

- Set the source selector to the AV position.
- Set the source to play.

Playing digital sources

- Set the source selector to play the source you want to hear (positions 5 for cable or 6 for optical).
- Set the source to play.

Playing USB digital audio sources (USB B input)

Sources for USB music will generally be files streamed to or stored on a personal computer.

Your computer may require additional drivers to play audio via the ONE Cast so ensure the computer has an Internet connection before first use of USB audio.

- Set the source selector to the  position.
- Before playing USB music, change the audio settings on the computer to output sound to the Cyrus ONE Cast device.
- Play the music file.

Playing DSD audio (USB B input)

DSD Audio files will also be stored on a personal computer.

Playback of DSD files will require the installation on the computer of a specialist music playback app that supports DSD playback.

- Before playing DSD music, choose, install and configure a DSD player app on the computer.
- Set the source selector to the  position.
- Play the DSD music file.

Playing HDMI (ARC) sound

- Set the source selector to the  position.
The TV sound will automatically switch to play through the ONE Cast.

When playing sound from an HDMI (ARC) equipped TV, the ONE Cast standby and volume controls will link to the TV as follows -

- When the TV volume setting is changed the ONE Cast will change volume.
- When the TV sound is muted the ONE Cast sound will mute.
- When the TV is set to Standby or switched on, the ONE Cast will also set to Standby or switch on (if it was last set to play HDMI sound).

NOTE: Not all TVs will support these features.

Operation

Advanced operation

AV Direct mode

When AV Direct mode is set, the Cyrus ONE Cast switches to work as a power amp when the AV source is selected. This means you can use Cyrus ONE Cast as a high quality front channel drive for a Home Cinema system.

CAUTION: Setting AV Direct mode will fix the volume control at a high level whenever the AV source is selected. Use this setting only when the AV input is connected to the front channels of an AV Home Cinema decoder, or with other sources that include a volume control.

Setting AV Direct mode

This setting can only be changed within 20 seconds of switching on the ONE Cast from Standby.

- Switch on the ONE Cast.
- Within 20 seconds, set ONE Cast to AV input and press AV DIR on the remote control.

The AV source indicator will flash and the volume display will indicate the current AV mode as shown below.

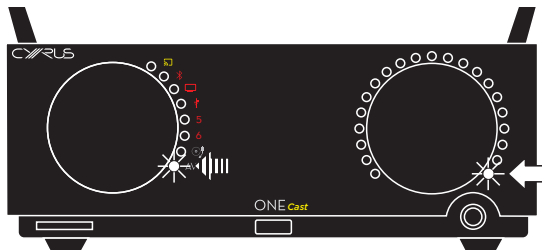

AV Normal mode

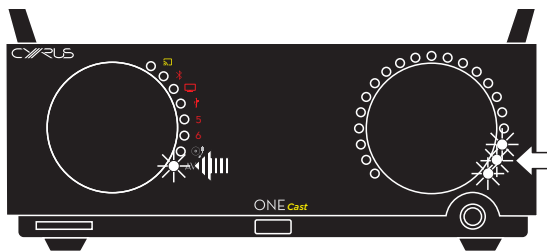

AV Direct mode

- Press the  button repeatedly to switch between normal and AV Direct mode.
- When the display shows the mode you want, press AV DIR again to store the setting and exit.

Connecting to a Home Cinema decoder

- Connect the front left and right pre-out channels of the Home Cinema receiver to the AV sockets on the Cyrus ONE Cast.
- Connect the front left and right speakers to the speaker terminals of the ONE Cast.
- Connect all other speaker channels directly to the Home Cinema receiver.

In Use

- Select AV at the ONE Cast when playing a movie and a fixed volume setting will be applied.

The front channel sound from the Home Cinema receiver will play through the Cyrus ONE Cast.

Volume operation will return to normal when another input is selected.

Reset

Factory reset

Cleared settings

Factory reset will clear all settings including -

- Wireless network setting
- **Bluetooth** pairing list.
- Last used volume and source settings.
- Stored balance setting (restored to central setting).
- AV Direct mode setting (when set).

Reset options

There are two methods to reset the ONE Cast.

- Version display with optional factory reset.
- Version display with automatic factory reset.

Resetting with optional factory reset

Follow these instructions to display the installed software version, then have the option to reset to factory settings.

- **!** Factory reset can only be selected from the front panel within 10 seconds of switching on the ONE Cast.

- Switch on the power.
- Within 10 seconds, hold down  on the remote control for 5 seconds.

The software version will be displayed as shown below on the front panel display.

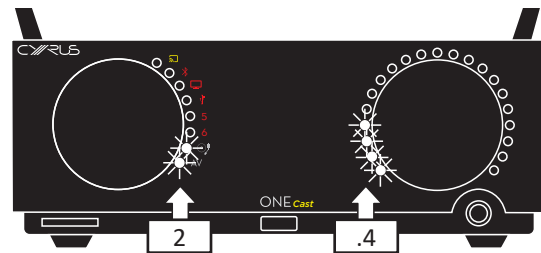

This example shows V2.4

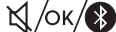
- To continue and reset the ONE Cast settings, Press  within 5 seconds.

All front panel indicators will flash twice to confirm settings have been reset.

If no action is taken, then the ONE Cast will return to normal operation after displaying the software version.

Resetting with automatic factory reset

Follow these instructions to display the installed software version, then automatically reset to factory settings.

- **!** Factory reset can only be selected from the front panel within 10 seconds of switching on the ONE Cast.

- Switch on the power.
- Within 10 seconds, turn the volume control anti-clockwise continually.

All front panel indicators will flash twice to confirm settings have been reset.

Firmware update

Automatic update

To ensure you continue to get the best user experience and access to the latest features, your Cyrus ONE cast may periodically update its firmware automatically via its Wi-Fi connection.

There is no procedure to manually update the firmware.

First use

Updates may already be available when you first use your ONE Cast. If so, these will be installed after first Internet connection.

Routine updates

The ONE Cast will regularly check for updates between 3am and 5am local time (where local time is set through the Google Home app).

Installation is fully automatic and requires no user intervention. In normal use you should not be aware that an update has taken place.

If the ONE Cast is in continual use, the update will be installed after 24 hours.

Priority updates

If the update is rated as a high priority, the ONE Cast will pause operation and update immediately.

Update indication

If an update is installed during use, the Cast LED will flash cyan as shown below. If you see this indication, there is no need to take any action, just keep mains power connected and wait for the update to complete.

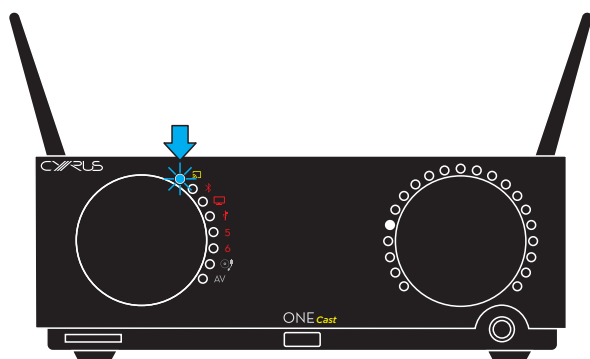

Troubleshooting

No sound or problems with the sound

This section covers general audio problems such as no sound or loss of one channel.

No sound, basic checks

- Check that the volume is turned up.
- Check that the correct source is selected and the source or mobile app is playing, not paused.
- Check that mute is not set (minimum volume indicator will be flashing when muted).

If these checks are OK -

- Check by playing a different source. If another source plays OK, then the problem may be with the source or its interconnect.

If there is still a problem this may be due to connection -

- Disconnect the ONE Cast from mains power.
- Check both ends of all connections from sources.
- Check both ends of the speaker connections.



No sound when streaming audio via Wi-Fi

If the basic checks haven't cleared the problem -

- Check the colour of the status indicator.
 - If the indicator is white, a mobile is already connected to the ONE Cast. Confirm that the mobile you are using is the one connected to the ONE Cast and that the music is playing, not paused.
 - If the indicator is green, the ONE Cast is connected to Wi-Fi and waiting for a music stream. From your mobile, play some music from an app and choose the ONE Cast as the device to play it on.
 - If the indicator is yellow the network may have lost internet connection. Use a mobile or computer to check that your network has connection to the Internet. If the Internet connection is good, refer to page 13 to set up the ONE Cast.

No sound when playing Bluetooth audio

If the basic checks haven't cleared the problem -

- Check that the source selector is set to the  position.
- Check if the  indicator is flashing.
- If the indicator is not flashing (steady white) then the ONE Cast is connected successfully -

- Check that you are playing music from a mobile app and that the app is not paused.

If there is still a problem this may be due to another mobile connected to the ONE Cast -

- From the **Bluetooth** menu of your mobile, check if it is connected to the ONE Cast. Only one connection is possible at a time so you will first need to disconnect the connected mobile.
- If the indicator is flashing then there is no **Bluetooth** source connected -
 - From the **Bluetooth** menu of your mobile, check that **Bluetooth** audio is switched on and that it is paired to the ONE Cast. If it is not paired then run a search for **Bluetooth** sources and pair your mobile with the ONE Cast. Once paired the mobile should connect and the indicator will stop flashing.
 - If you encounter any problems with pairing the mobile, try clearing the **Bluetooth** memory. Hold the  button on the remote control until the indicator double-flashes. Now try to pair with ONE Cast.

Troubleshooting

No sound or problems with the sound

No sound, digital inputs 5 and 6

- Check that the sample rate of the audio playing is compatible with the ONE Cast in the range 32k - 192k.
- Check that the format of the audio playing is 2 channel PCM stereo. Compatible sources include CD players, DVD players (when playing a CD or set to output 2 channel PCM), DAB radios etc. The ONE Cast will not play multi-channel surround-sound from a DVD.

No sound, USB audio

- Check the computer audio settings. The audio must be set to output sound to 'Cyrus ONE'.

No sound, DSD audio playback via USB

- Ensure that a DSD player app is installed and correctly configured on the computer.
- Check that the DSD file type is compatible with the Cyrus ONE Cast.

No sound, HDMI audio

- The ONE Cast is only compatible with HDMI (ARC) TVs. Check that the ONE Cast is connected to an outlet on the TV marked 'HDMI (ARC)'. A standard HDMI connection will not work.

Sound from only one speaker or one speaker louder than the other

- The balance control may not be correctly set. Press the L or R button on the remote control to display the current balance setting and adjust if necessary.
- Are there fuses in your speakers? If so, check if one of the speaker fuses has blown.

If these checks are OK -

- If all sources are affected, disconnect the ONE Cast from mains power.
- Check both ends of the connection to the speaker that is not working.

For AV or phono sources only -

- Disconnect mains and check connection to that source.

Very loud, distorted sound when playing a vinyl turntable

- The turntable may include a built-in preamplifier to give a high, line level output. This is not suitable for connection to the phono input of the ONE Cast. Turntables with built-in preamplifiers should be connected to the AV input.
- The turntable may have an output selector. If so, it should be set to the 'phono' or 'cartridge' position, not to the 'line out' or 'preamp' position.

Low volume when playing a vinyl turntable

- The phono input of ONE Cast is configured for a MM (moving magnet) cartridge. Check that you have connected a turntable with a moving magnet cartridge. A MC (moving coil) cartridge can be used but will require an external step-up transformer or preamplifier.

Hum or other noises when playing a vinyl turntable

- Check that the cable from the turntable is not routed near any amplifier (such as the ONE Cast) or other system component that may contain a large power transformer. Try to route the cable clear of any other products.
- Some turntables have a chassis ground connection. This is normally a single wire and should be connected to the screw terminal on the back panel.

If these checks are OK -

- Sometimes connecting the turntable ground connection can increase hum and noise. Set a low volume level and test with the ground disconnected.

If this check does not improve the problem -

- Contact a retailer who has experience with vinyl turntables to get the turntable wiring checked out with the ONE Cast.

Troubleshooting

Operational problems

ONE Cast sets to Standby occasionally

- *ONE Cast features energy saving automatic Standby. After 20 minutes without playing any music or making adjustments to the controls the ONE Cast will set to Standby. This is normal.*

Front panel controls are not working

- *The controls may be locked. If the controls are locked the indicators will flash when the controls are moved. Refer to page 11 to clear the lock setting.*

Remote control is not working

- *You may be too far away from the ONE Cast. Bring the remote control close to the front of the ONE Cast and re-check.*

If there is still a problem

- *The batteries may need to be replaced. Refer to page 10 for instructions to replace the batteries.*

Troubleshooting

Unable to set up Wi-Fi using Google Home

Identifying if setup has failed

- *The Google Home app will give you feedback at each stage during setup. If the app shows that setup could not be completed then follow the prompts in the app and repeat setup if necessary.*

Basic checks

If ONE Cast setup persistently fails and the status indicator is flashing yellow slowly it is advisable to run some basic checks first.

- *Check that Wi-Fi is switched on at your mobile and it is connected to the network where you will join the ONE Cast.*
- *Check that **Bluetooth** communication is enabled on the mobile setting up the ONE Cast (this is only necessary during setup).*
- *Check that your Wi-Fi network has internet connection. Use a computer or mobile connected to the Wi-Fi network to navigate to some web pages etc and ensure that the Wi-Fi network is functioning correctly.*
- *Check that your Wi-Fi network can reach the location of the ONE Cast. Hold a mobile close to the ONE Cast and check the available Wi-Fi signal strength. If the signal strength appears weak, move the ONE Cast closer to the source of Wi-Fi temporarily where the signal is stronger and re-try setup. If this works a Wi-Fi signal repeater may be necessary.*
- *If setup continually fails then factory reset the ONE Cast and re-start the mobile before re-attempting setup.*

Unable to set up Apple AirPlay

ONE Cast does not appear in the AirPlay device list

- *When opening the Wi-Fi settings, ONE Cast does not appear in the list of available AirPlay devices. The ONE Cast may already be setup, or the AirPlay setup time may have expired. Factory reset the ONE Cast and re-check the list of available AirPlay devices.*
- *Check that your Wi-Fi network can reach the location of the ONE Cast. Hold a mobile close to the ONE Cast and check the available Wi-Fi signal strength. If the signal strength appears weak, move the ONE Cast closer to the source of Wi-Fi temporarily where the signal is stronger and re-try setup. If this works a Wi-Fi signal repeater may be necessary.*

If you are still unable to complete setup, there is a full setup guide available on the Cyrus website that includes step by step screenshots.

Audio streaming troubleshooting

This section provides help for problems playing music over Wi-Fi after the ONE Cast has been successfully set up.

Audio streaming stops working

The status indicator of the ONE Cast will show status of the Wi-Fi connection.

- *If the status indicator is white then the ONE Cast is connected to Wi-Fi and a mobile is already connected for streaming to the ONE Cast. There may be another reason that you are not hearing any sound. Check out the 'No sound, basic checks' section at the start of Troubleshooting.*
- *If the status indicator is green then the ONE Cast is connected to a wireless network that has internet connection. If the indicator is green but you cannot stream music to the ONE Cast via the network then the ONE Cast and mobile may be connected to different networks. Check that the mobile is connected to the correct Wi-Fi network.*
- *If the status indicator is flashing yellow slowly this indicates that your Wi-Fi network has failed or lost internet connection. Follow the basic checks in the next section.*

Basic checks

- *Check that your Wi-Fi network has internet connection. Use a computer or mobile connected to the Wi-Fi network to navigate to some web pages etc and ensure that the Wi-Fi network is functioning correctly.*
- *Have you moved the ONE Cast to a different location with a different Wi-Fi network? Have you changed the router or settings of your Wi-Fi network? If any changes have been made it will be necessary to factory reset the ONE Cast and run Wi-Fi setup again.*

Troubleshooting

Diagnostic system

Error display

Your amplifier has a unique diagnostic system to help you to diagnose problems. There are five error messages that may be displayed – PSU, Left or Right output, Over-temperature and System.

These are displayed by light patterns on the source indicators. When an error is detected all the source indicators will light except one that flashes to indicate the type of error (5 in the example below).

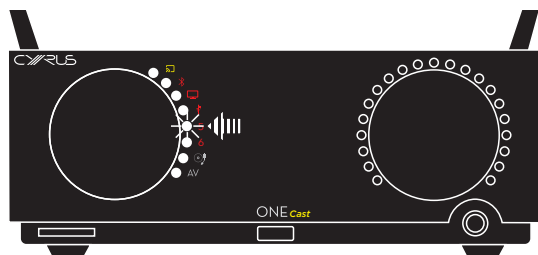

Clearing an error

- ! To clear an error, stop any music that was playing and disconnect mains power from the amplifier. Wait for 10 seconds and reconnect mains power.





The amplifier should switch on as normal.

If the error indication was Over-temperature, you may need to disconnect the ONE Cast and wait for it to cool.

If an error condition persists, return the amplifier to your Cyrus appointed retailer or an authorised Service Centre.

Error types

The error type can be identified from the table.

Flashing	Fault
	PSU
	Left channel output
	Right channel output
	Over-temperature
5	System

PSU error

- This error will be displayed if the internal power supply is out of range.

This may be a temporary condition when playing excessive levels of deep bass or could be a fault condition in the power supply.

Left and Right Output errors

- The output of the indicated channel has been overloaded. This is usually due to the volume being set too high for prolonged listening.
- It could also be due to a short-circuit at the loudspeaker terminals of the channel indicated.

If this error persists, switch off the amplifier and check that there are no short circuits at either end of the speaker wiring.

Over-temperature error

- The amplifier has over-heated internally.
Check that the ventilation slots on the top, bottom and sides of the amplifier are not obstructed.
The amplifier will mute and cannot be re-started until it has cooled down. If this happens regularly, try improving the ventilation around the case. If the problem continues, then the impedance of your speakers may be too low.

System error

- There is an internal circuit error.

Specifications and warranty

ONE Cast specifications

Power Supply

Voltage As plate on rear of unit

Power Consumption

Maximum 750W

Safety Compliance CE

EMC (230V)..... CE

EMC (115V)..... FCC

Enclosure

Dimensions (WxHxD)..... 220 x 86.5 x 390 mm

Weight 5.72kg

Material Non-ferrous chassis

Analogue audio performance

Recommended speaker power handling >100W

Recommended speaker load impedance 4Ω-8Ω

Power output (2 chans driven) 6Ω >120W

THD+N (1kHz, $\frac{1}{3}$ power) 6Ω <0.02%
(both channels driven)

Frequency response (-3dB) AV 6Hz > 50kHz

S/n ratio (A-WTD) AV 95dBA

Input sensitivity (50W/8Ω) AV 180mV

Input impedance AV 47kΩ

Input sensitivity (50W/8Ω) Phono 0.9mV

Input impedance Phono 47kΩ

Maximum output voltage Pre out 2.4V

THD+N (1kHz, 600mV) Pre out <0.003%

S/n ratio (ref 600mV) Pre out >100dBA

Cable and optical digital audio

Cable input voltage 500mV pk-pk

Cable input impedance 75Ω

Optical connection Toslink

Sample rate range 32k - 192k

Digital audio formats PCM stereo only

USB digital audio

USB formats asynchronous digital audio

USB sample rates 32k - 192k

DSD (via USB) DSD64

Digital audio performance at Pre-out

S/N ratio (Pre-out, 0dB FS, 600mV out) >107dBA

THD+N (Pre-out, 0dB FS, 600mV out) <0.003%

Cyrus reserves the right to change all specifications without notice. E &OE

Warranty

The warranty period is two years. No retailer or distributor may vary the terms of this warranty, which is personal to the original purchaser and is not transferable.

Please retain the sales receipt as proof of purchase.

Warranty claims must wherever possible be made through the retailer from whom the equipment was purchased.

This warranty excludes:

- Damage caused through neglect, accident, misuse, wear and tear, or through incorrect installation, adjustment or repair by unauthorised personnel. Any unauthorised servicing will result in loss of warranty.
- Liability for damage or loss occurring in transit to or from the purchaser.
- Consequential damage, loss or injury, arising from or in conjunction with this equipment.

Equipment for attention under warranty should be consigned return carriage paid. If returned equipment is found to comply with the published specification, CYRUS reserves the right to raise a charge.

The above conditions do not affect your statutory rights as a consumer.



Cyrus Audio Ltd., Ermine Business Park, Huntingdon, PE29 6XY, U.K.