

SoundSpot™ Satellite Speakers
SoundStand™ ST-95
USER MANUAL

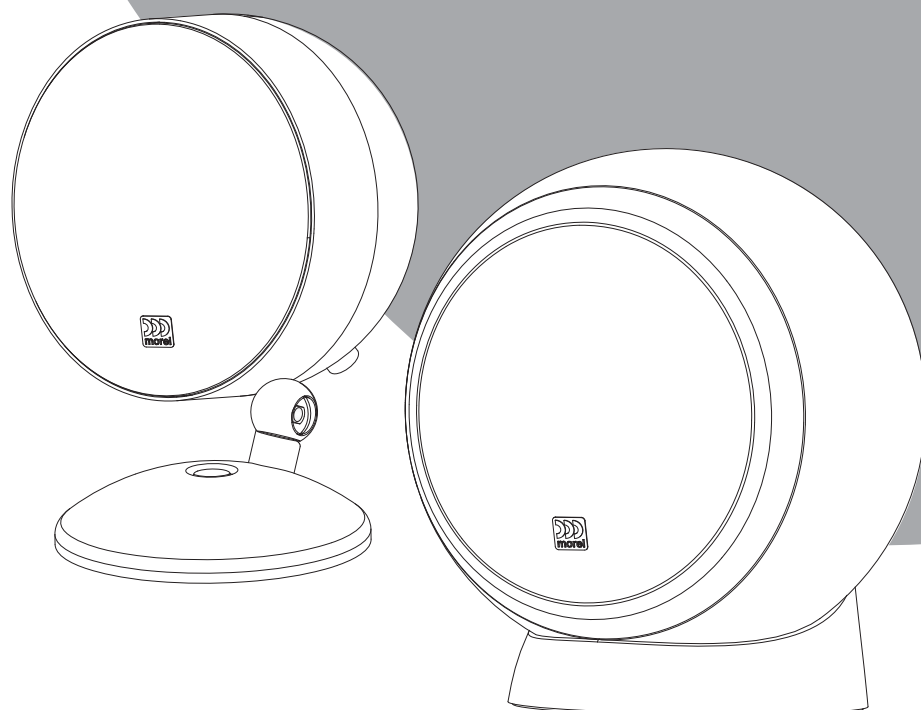

Thank you for choosing Morel SoundSpot™ loudspeakers

These speakers are uniquely designed and constructed, to offer extraordinary sound quality for both stereo and home theatre applications. The Morel SoundSpot speakers have been handcrafted by Morel utilizing the highest-quality materials and components.

Morel's utmost attention and care has been devoted to the design and construction, to ensure you a long-lasting enjoyment of our product. The information in this manual will help you get the best possible performance out of your speakers. If you have any questions, please contact your Morel Authorized Dealer, or Morel Support at www.morelhifi.com.



The more you play the better it sounds

As in any high-end speaker system, the Soundspot satellites must be used for a short period of time before they reach peak performance.

Due to the unique speaker design, we recommend a 48-hour break-in period.



Using quality cables and connectors can improve speaker performance

A good speaker cable connection requires ample surface-area and contact-area pressure. Morel recommends you consult your local Morel Authorized Dealer for the most suitable cables to match your system and budget.

Recommended speakers placement

Home Theater

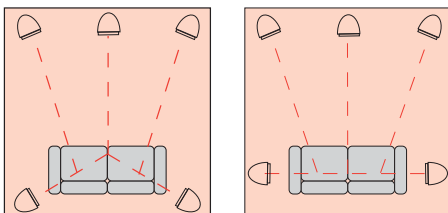

stereo

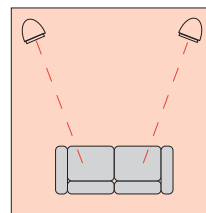

Recommended subwoofer placement

A

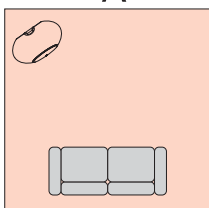

B

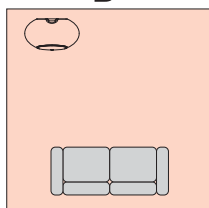

C

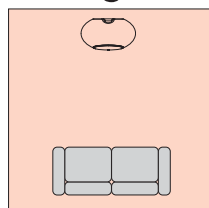

D

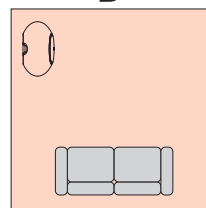

E

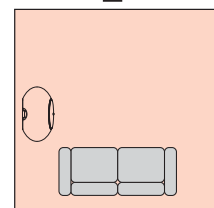

SoundSpot™

The SoundSpot™ satellite speakers are two way point source systems. Delivering a more stable and consistent off axis sound reproduction ensuring you a fantastically rich musical experience.

The Soundspot™ speakers offer you great flexibility and ease when it comes to speaker placement and mounting options. Please see the following pages for guidance.

SoundSpot™ SP-1 mounting options

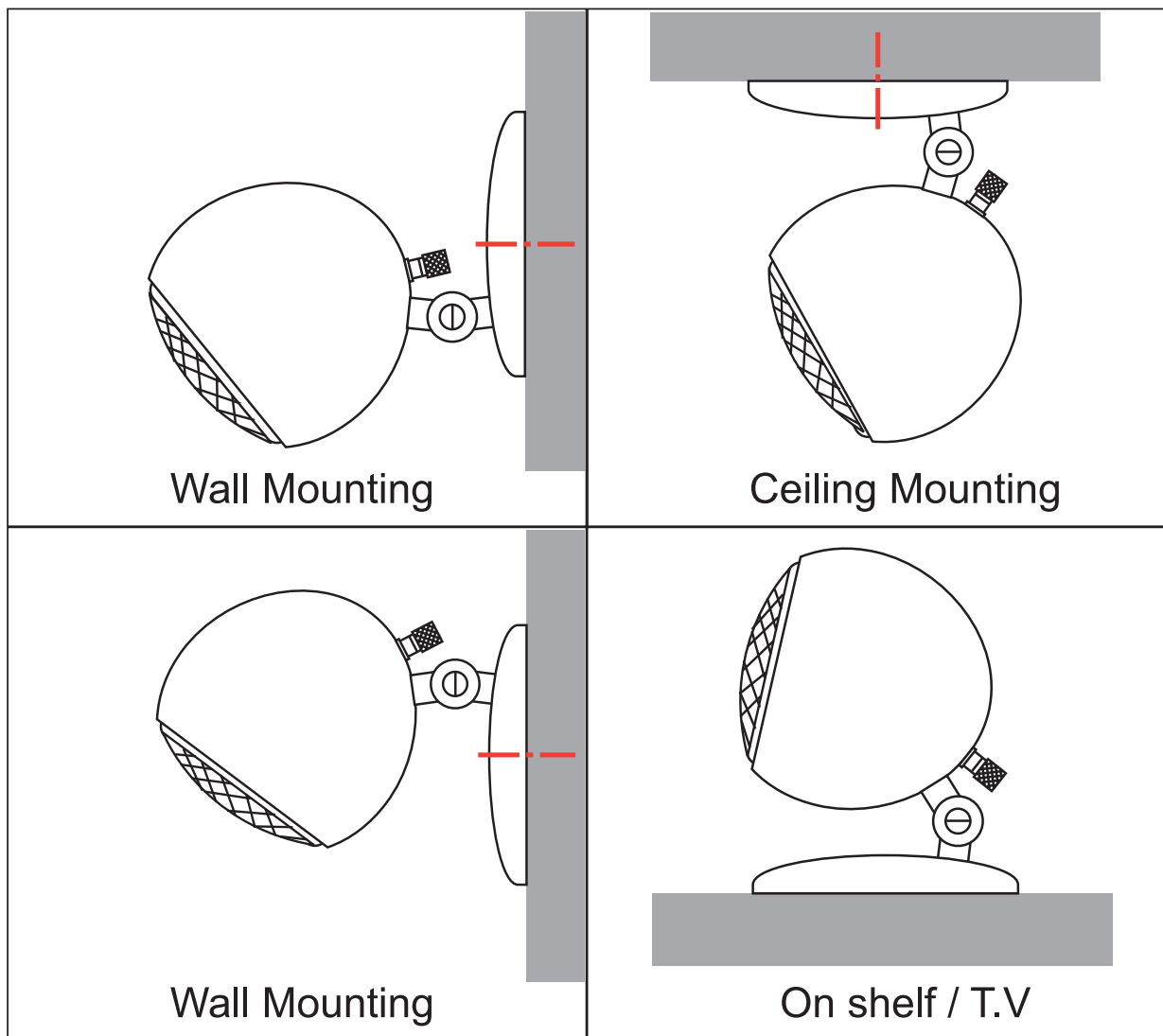

* Fitted on the specially designed (optional) ST-95 floor stands (see p. 7- 8).

Mounting the SoundSpot™ SP-1 Speakers (on the wall)

1. Snap on the rubber footing

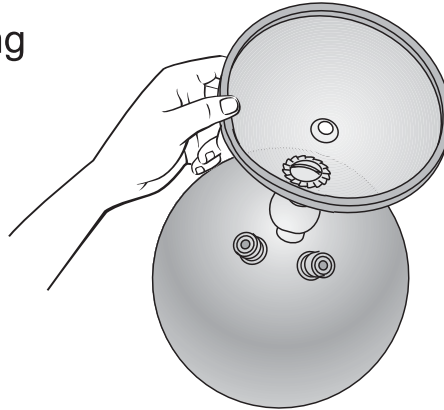

2. The SoundSpot™ speakers are equipped with a pivoting base that turns 180°. To change the orientation of the base, to best conceal the base in the selected mounting option, loosen the screw that locks the base position (located under the base), rotate the base a full 180° and firmly tighten the screw.

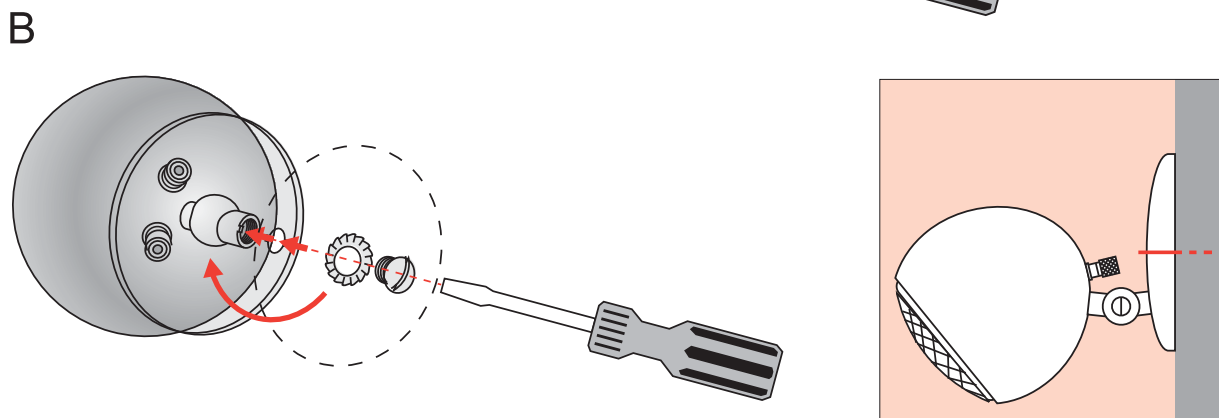
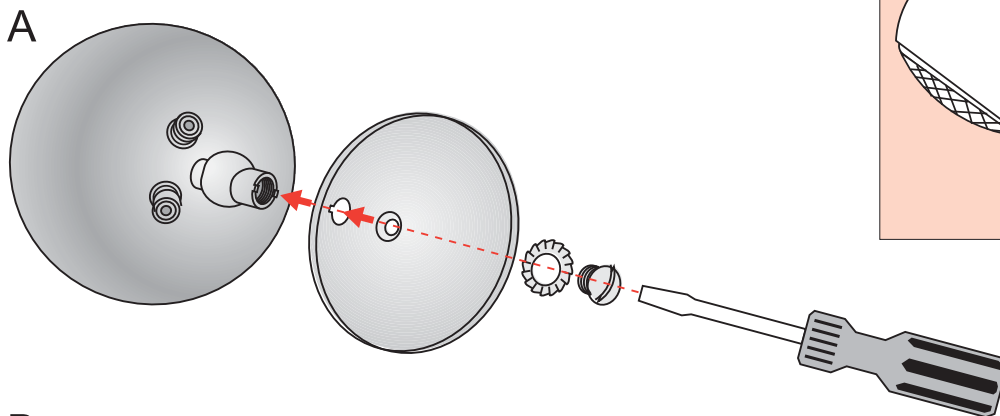

3. To mount your SoundSpot™ SP-1 speaker on a ceiling or wall, first choose the location you desire for the speaker and mark the precise spot where you will drill a hole so it lines up with the hole in the speaker base. Next, drill a hole in the wall using a 7mm (0.275") bit, and insert the plastic plug. Attach the speaker using the fixing screw. Cover the screw head with the plastic screw cover provided. Finally, adjust the speaker angle until the speaker is directed towards the listening area, and lock it in place.

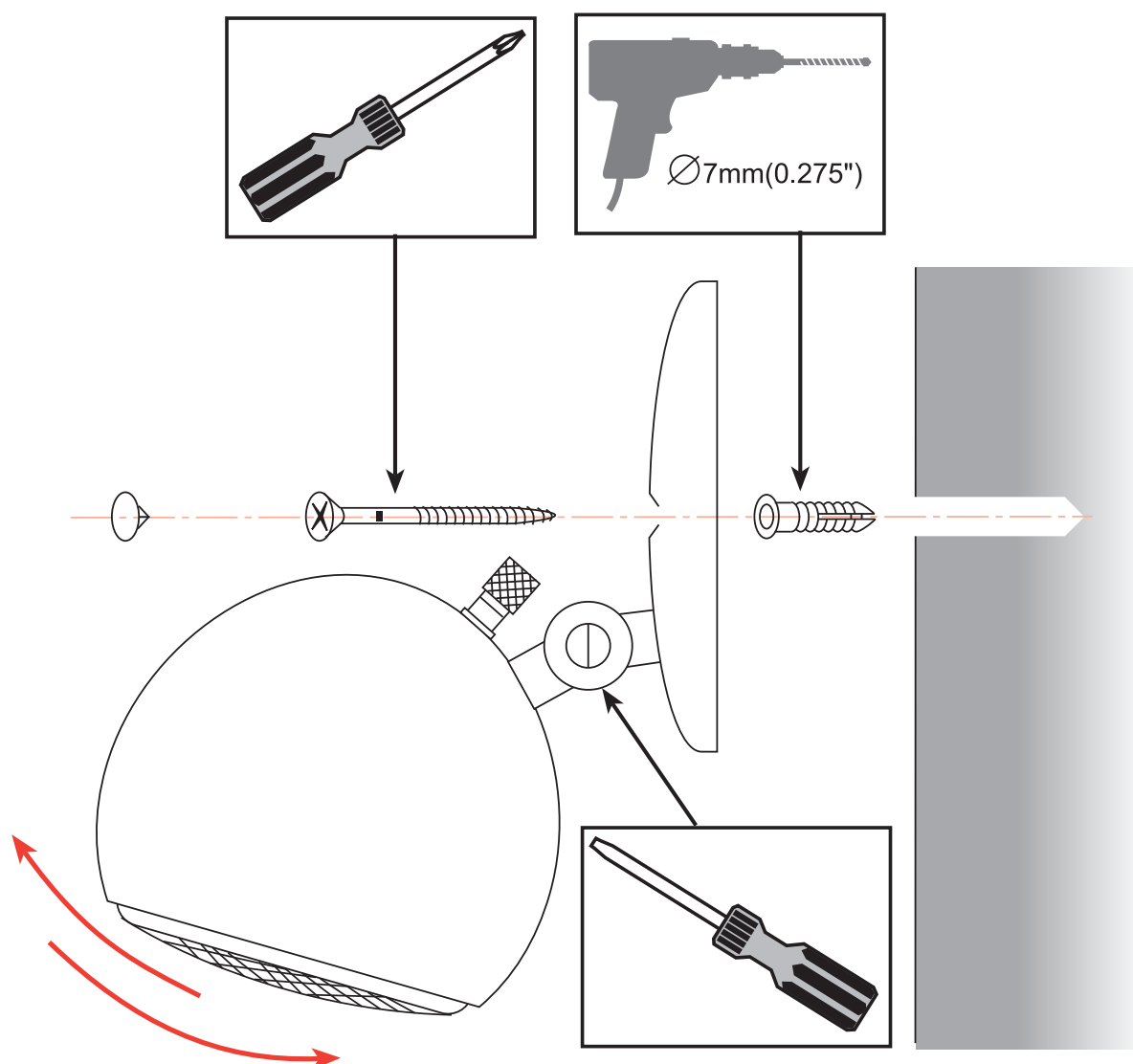

To mount your SoundSpot™ SP-1 speakers on the floor stand, see page 8.

Mounting the SoundSpot™ SP-2 Speakers (Shelf / TV)

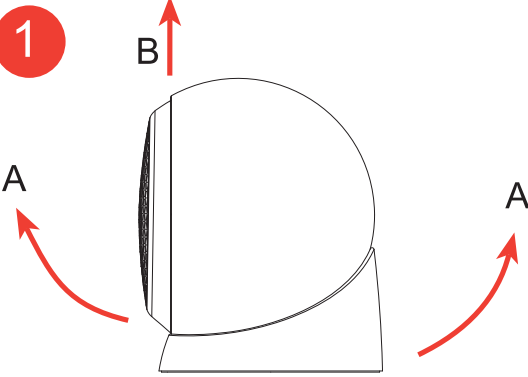
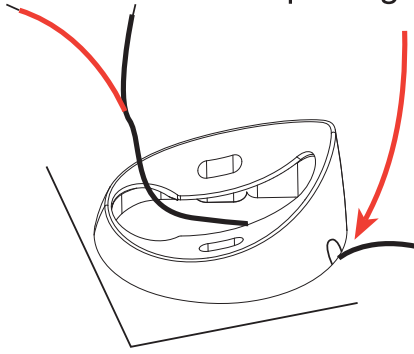
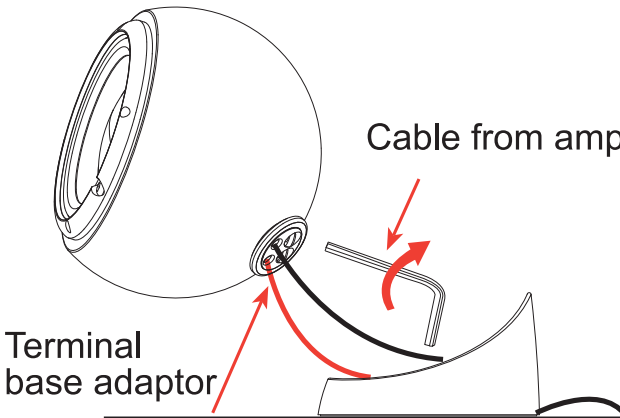
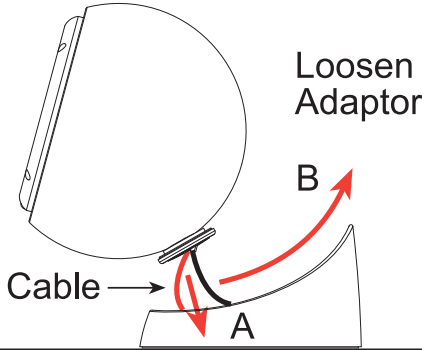
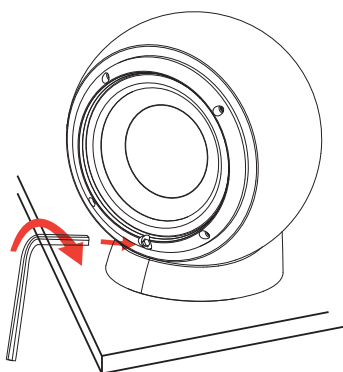
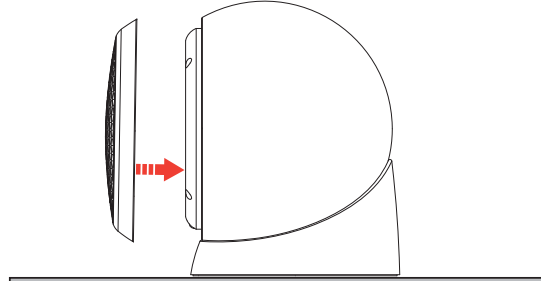
<p>1</p>  <p>Take off the speaker from the base by removing the grill and releasing the locked screw with an allen key (see no. 5).</p>	<p>2 Speaker base</p> <p>Please trim the plastic for the cable opening</p> 
<p>3 Lock cable inside the terminal hole</p>  <p>Cable from amp</p> <p>Terminal base adaptor</p>	<p>4 Insert the terminal adaptor to the base</p>  <p>Loosen Adaptor</p> <p>Cable</p>
<p>5 Lock the speaker in the desired angle by securing the screw with moderate force</p> 	<p>6 Place the grill in position * Important: SP-2 grill is part of the acoustic design. Listen only with the grill on</p> 

Mounting the SoundSpot™ SP-2 speaker (Wall / Ceiling)

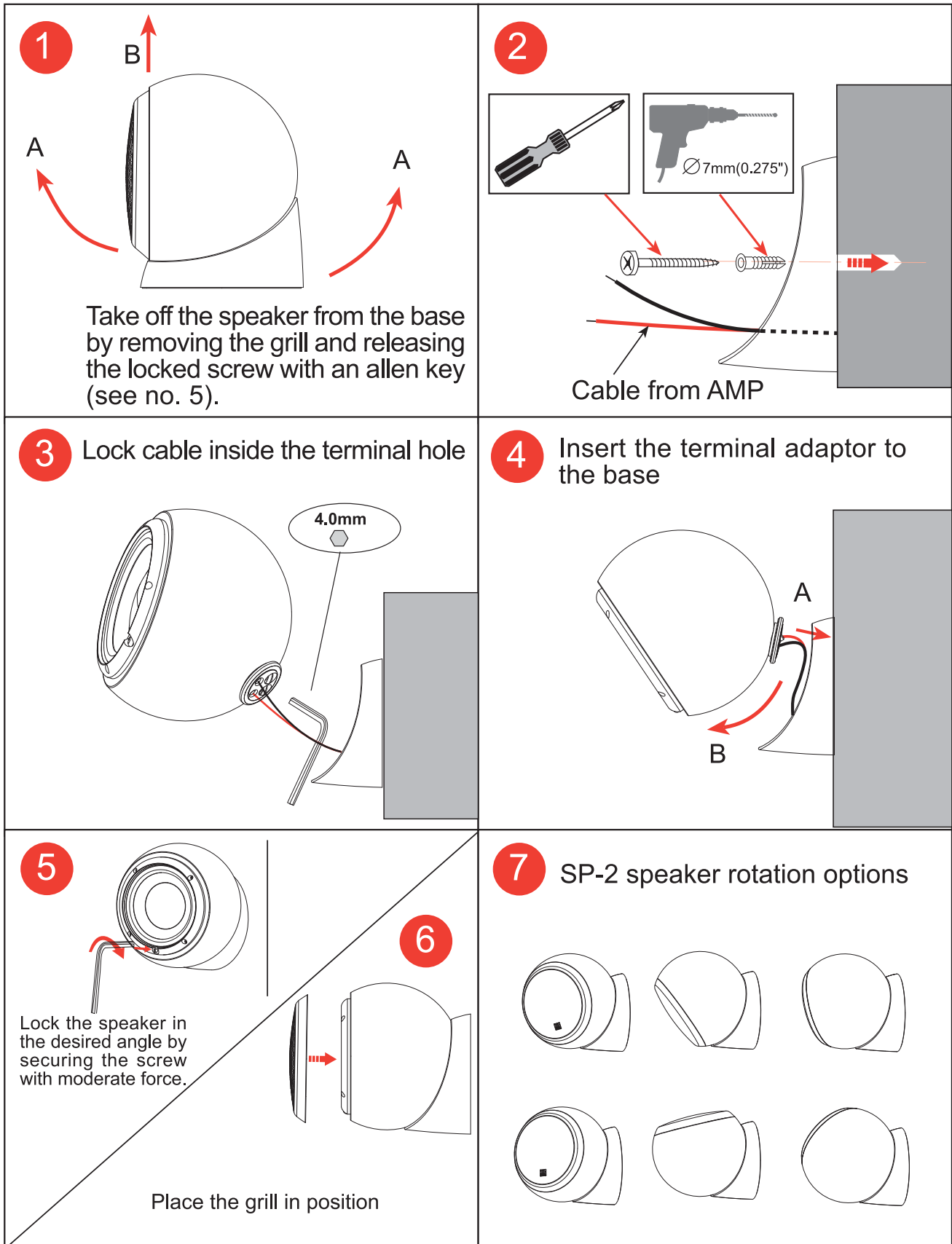

SoundSpot™ ST-95 Stand for SP-1 speakers

Installation Instructions (optional units)

Carefully fasten the tapered tube to the base. **Make sure that the tube is perpendicular to the base. Do not use mechanical tools or excessive force.** If for some reason there is a gap between the tube and the base, it means the tube was not screwed in completely into the base. Please repeat the process with the tube positioned precisely perpendicular.

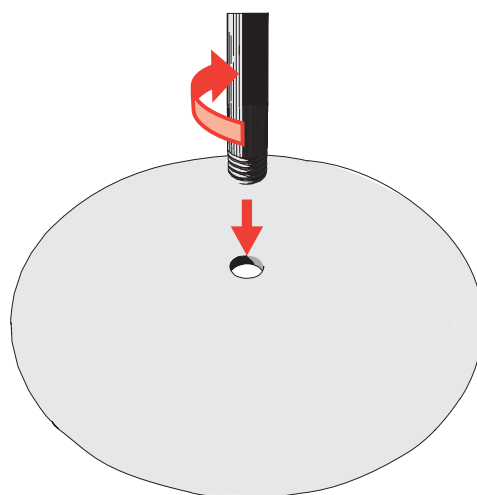
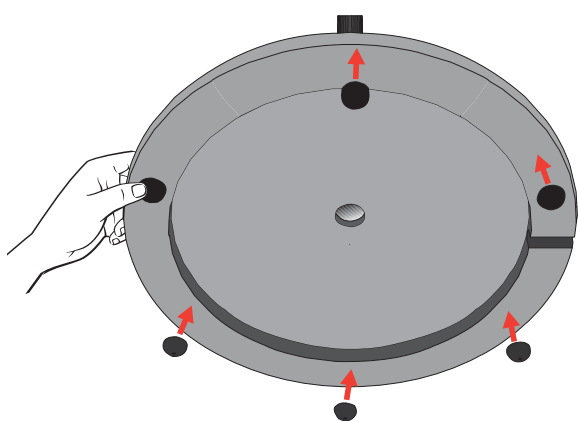

To protect delicate floor surfaces use the supplied rubber pads and press them onto the bottom of the stands base in six different locations.

Conceal the cable in the SoundStand ST-95

Slip the speaker cable through the hollow tube, and out of the opening near the top of the tube (under the bolt).

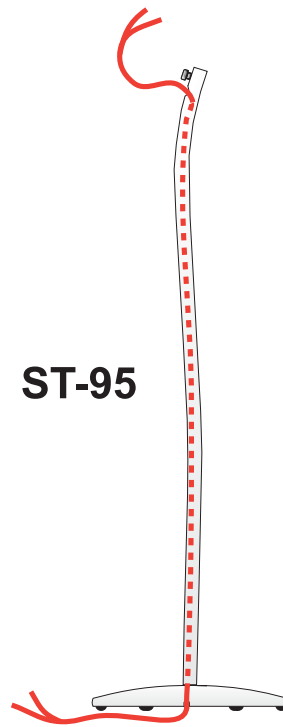
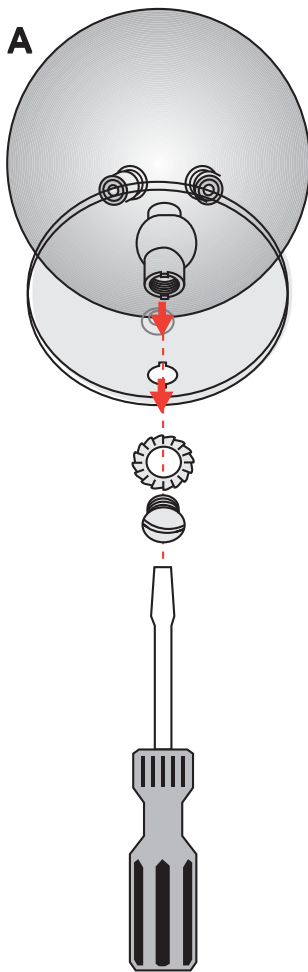

Connect the speaker to the stand by removing the speaker base (fig. A) and insert the exposed joint into the stand tube (fig. B). Secure the bolt (fig. C), locking the speaker to the stand.

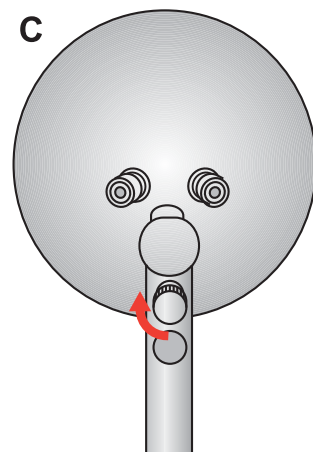
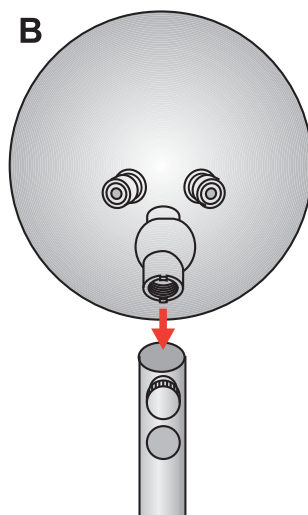

To complete the setup, connect the speaker cable to the speaker's input terminals, following the installation instructions in your speaker manual.

Amplifier Connection



Unplug the electrical connection of the amplifier before making any connections.

For each speaker, connect the red or (+) output terminal on your amplifier to the red input terminal on the speaker and connect the black or (-) output terminal on the amplifier to the black input terminal on the speaker.

LARGE, SMALL Speaker Amplifier Setting

Surround sound amplifiers have a speaker setting option for **large** or **small** speakers. This setting option is made to protect small speakers by filtering low frequency signals, which may harm the speaker at a high power output.

Set your SP-1 or SP-2 Speaker to the **small** speaker setting. Regardless of your speaker setting or your amplifier's rated power capacity, **do not operate the speakers at full output levels (highest volume)**, as the high levels of distortion generated by amplifiers at full output may damage your speakers.

Caring for the SoundSpot™ Speakers

To protect the speaker components, avoid operating the speaker in extreme humidity or adverse temperature conditions.

SoundSpot™ specifications

SPECIFICATIONS	SP-1
Construction	Steel half-sphere enclosure
Enclosure Diameter	4.3" (110 mm)
Drive units	Woofers: 3 1/2" (85mm) woofer with 3/4" (19 mm) high temperature voice coil, ferrite magnet motor. Tweeter: semi-soft polymer 1/2" (12mm) liquid-cooled voice coil, neodymium magnet motor
Nominal impedance	6 ohm
Power handling	60W (100W Transients)
Operating power	15-100W
Crossover	8,000Hz 6 dB \ Octave
Frequency response	100-22,000Hz (-5dB)
Sensitivity 2.83V/1M	87 dB
Net weight	2.3 lbs (1 Kg)
Finish	Piano white, Piano black, Champagne

SPECIFICATIONS	SP-2
Construction	Steel sphere enclosure
Enclosure Diameter	5.5" (140 mm)
Drive units	Woofers: 4" (100 mm) woofer with 1.2" (32 mm) high temperature voice coil, ferrite magnet motor. Tweeter: Soft dome 3/4" (19 mm) liquid-cooled voice coil, neodymium magnet motor
Nominal impedance	6 ohm
Power handling	80W (150W Transients)
Operating power	15-100W
Crossover	2,200Hz 12 dB \ Octave
Frequency response	90-22,000Hz (-5 dB)
Sensitivity 2.83V/1M	86 dB
Net weight	3.3 lbs (1.5 Kg)
Finish	Piano white, Piano black, Champagne



www.morelhifi.com