

# IS-1000 /Deluxe/Line

INTEGRATED AMPLIFIER AND STREAMER



# INDEX

PACKAGE CONTENT.....	P. 3
DESCRIPTION AND SPECIFICATIONS.....	P. 4
FRONT PANEL.....	P. 6
REAR PANEL.....	P. 7
DISPLAY.....	P. 8
QUICK-START.....	P. 9
CONTROL APP.....	P. 10
NETWORK SETUP.....	P. 15
IS-1000 FEATURES.....	P. 17
REMOTE CONTROL.....	P. 18
CONNECTING OTHER SOURCES.....	P. 19
IMPORTANT NOTES FOR MCONNECT CONTROL ONLY.....	P. 20
WARRANTY.....	P. 21
TROUBLESHOOTING.....	P. 22
IMPORTANT SAFETY INFORMATION.....	P. 23

## PACKAGE CONTENT

- IS-1000 / IS-1000 DELUXE /IS-1000 LINE
- 1 AC cable
- 1 Ethernet cable
- 1 Wi-Fi antenna
- 1 Remote control + battery
- User manual

## DESCRIPTION AND SPECIFICATIONS

### IMAGINE A COMPLETE HIGH-END STEREO SYSTEM ENCLOSED IN A BEAUTIFUL CHASSIS CARVED IN BOLD ITALIAN STYLE:

With the knowledge and the experience developed in over 20 years of research, we are now able to offer an all-in-one solution powered by the most advanced technologies and components to achieve true audiophile quality sound.

IS-1000 is an advanced fully integrated amplifier that redefines the way music playback is experienced to achieve a new pinnacle in High-End audio, seamlessly merging an Integrated Amplifier, a Phono Preamp, a DAC and a Streamer in a unique, complete source.

The refined technical innovations of IS-1000 come directly from our flagship models, like the preamplifier P-1000 and the power amplifier PA-1175, which inspired us to create a new source that would integrate the analogue components of a high quality amplifier with the digital technologies of a Streamer and a DAC to deliver outstanding performances.

IS-1000 is a Roon Ready device, fully compatible with multi-room systems and with a quick plug&play installation: simply plug IS-1000 to the main A/C, connect it to your network (Wi-Fi or Ethernet) then to the speakers and start to explore the endless possibilities of music, streaming from Tidal & MQA via Tidal, Qobuz, Spotify & Spotify Connect and Deezer with Roon and our App GN Control available for free on iOS and Android.

You can also browse your collection of digital music stored on NAS, HDD and USB sticks (DSD 64 files converted to high-resolution PCM over UPnP protocol on USB and LAN, PCM up to 24/192).

You don't need anything else to experience at home the pleasure of high definition audio, just IS-1000 and your speakers. If you love vinyl records, connect your turntable directly into IS-1000 to use the Phono Preamp we designed and engineered, it's really that simple.

The heart of IS-1000 is the powerful integrated amplifier that offers 125W @ $\Omega$  8 developed using only the best audio grade components specifically chosen to deliver the ultimate performance.

The mind of IS-1000 is the advanced streamer based on the latest technology to guarantee perfect connectivity and access HQ music on TIDAL, QOBUZ, SPOTIFY and DEEZER and also the HQ web radio with V-TUNER.

No other cables, no additional boxes. Just endless music in High Resolution.



# DESCRIPTION AND SPECIFICATIONS

Integrated Amplifier: 125watt @ 8Ω per channel class AB Mosfet

Streamer: Tidal, Qobuz, MQA, vTuner, Spotify, Deezer Airplay and Roon Ready

App GN Control (available on iOS & Android)

Ethernet LAN and Wi-Fi (PCM24/192 and DSD64)

UPnP and DLNA supported

Phono Stage MM/MC

DAC IS-1000: BurrBrown PCM1796

DAC IS-1000 LINE: BurrBrown PCM1796

DAC IS-1000 DELUXE: BurrBrown PCM1792A

THD (Total Harmonic Distortion): 0,005% @ 5W

0,1% @ 0,1 to 50W (20Hz - 20kHz)

Damping Factor: >100

Output impedance: 50Ω

Ration Signal/Noise: >100dB Line and Digital Inputs

>80dB Phono (MM)

Booster: 3 adjustable levels (by-passable/off)

## ANALOG OUTPUTS

1 RCA variable

1 RCA fixed

## ANALOG INPUTS IS-1000/ IS-1000 DELUXE

1 XLR balanced

1 RCA Line / Phono MM/MC

1 RCA Line / AV-In

## ANALOG INPUTS IS-1000 LINE

1 XLR balanced

1 RCA Line

1 RCA Line / AV-In

## DIGITAL INPUTS

3 Optical Tos-Link PCM up to 24bit/192kHz

1 RCA Coax PCM up to 24bit/192kHz

1 USB-A port DSD64 and PCM up to 24bit/192kHz, formatted in FAT32/NTFS (32Gb max for pen drives)

## POWER

100-120V or 220-240V, 50/60Hz

Power consumption: 30W - 400W max

Standby consumption: < 0,5W

Fuse 220/240V 3,15A F/T

Fuse 100/120V 6,3A F/T

## SUPPORTED STREAMING SERVICES:

TIDAL & MQA via Tidal

Qobuz

Spotify & Spotify Connect

Deezer

V-Tuner

## SUPPORTED MEDIA SERVERS:

Minim

Bubble UPnP

All certified UPnP media servers

## SUPPORTED AUDIO FORMAT:

AIFF (aif, aiff, aifc)

WAV (wav) packed/unpacked

FLAC

WmA Windows media Audio 9

WAX Windows media audio metafiles

ASX Advanced Stream Redirector (asx)

MPEG-4 (aac, m4a , Apple lossless)

MP3

DSD64 [.dsf] files converted to high-resolution PCM over

UPnP protocol

## DIMENSIONS AND WEIGHT

Dimensions: 430 W x 135 H x 375 D mm

Weight: Kg. 18 net - Kg. 23 boxed

## APP

GN Control

# FRONT PANEL

## FRONT PANEL OVERVIEW

IS-1000 is a true High-End integrated amplifier and offers unique features to deliver the best audio quality.

Everything has been designed to provide the best experience and thanks to the exclusive SKC [Single Knob Control] the unit becomes a friendly plug-and-play source that can be fully controlled even without the remote.

All the information and features are easy to read and access on the display at any time, so you will also have complete control over the system.

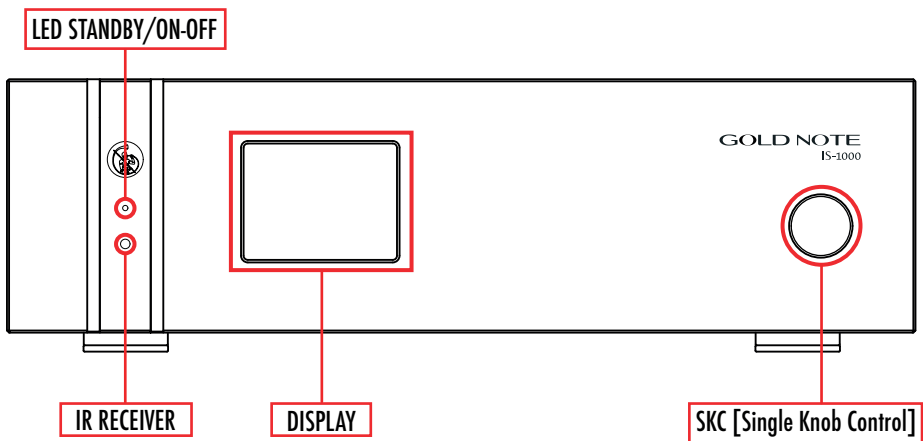

## TURNING ON/OFF IS-1000

to turn ON/OFF the unit, press and hold the knob for 3 seconds

## SELECTING A FUNCTION

1. press the knob once to activate the SELECTION FRAME
2. turn the knob left or right until the desired function is highlighted by the SELECTION FRAME then press the knob to select it
3. the frame will turn red: now you can turn the knob to change the function
4. press the knob again when the desired value is set to confirm and exit the selection

# REAR PANEL

## REAR PANEL OVERVIEW

IS-1000 features a wide selection of connections to offer the best versatility and become the core of a real High-End system that will deliver audio in true audiophile quality:

- 7 digital inputs (PCM up to 24bit/192kHz & DSD 64 )
- 3 analogue inputs (1 XLR balanced and 2 RCA unbalanced)
- 4 analogue outputs (variable and fixed)

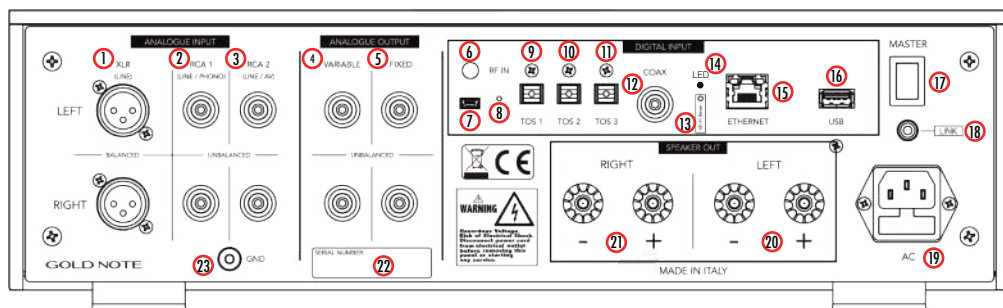

### ANALOG INPUT

- ① XLR balanced
- ② RCA 1 unbalanced (LINE or PHONO)
- ③ RCA 2 unbalanced (LINE or AV)

### ANALOG OUTPUT

- ④ RCA unbalanced VARIABLE
- ⑤ RCA unbalanced FIXED
- ②① SPEAKER OUT left
- ②② SPEAKER OUT right

### POWER

- ①④ Blue light LED
- ①⑦ Master Switch ON/OFF
- ①⑨ AC plug IEC standard

### DIGITAL INPUT

- ⑥ RF IN (Wi-Fi aerial)
- ⑨ TOS link 1
- ⑩ TOS link 2
- ⑪ TOS link 3
- ⑫ COAX
- ⑮ Ethernet
- ⑯ USB type A (USB flash memories)

### OTHERS

- ⑦ mini USB (Firmware update)
- ⑧ Firmware Reset *only for service*
- ⑬ Wi-Fi Reset (to connect to your Wi-Fi)
- ⑱ LINK sync trigger
- ⑳ Serial Number
- ㉓ GND (PHONO)

\***PLEASE NOTE:** RCA 1 unbalanced LINE on IS-1000 LINE. RCA 1 unbalanced LINE / PHONO on IS-1000 / IS-1000 DELUXE



# DISPLAY

## FUNCTIONS AND INFORMATION

The display of IS-1000 shows all the information in a clear and easy way.

Every function can be selected and adjusted quickly using the knob, the remote and the App .

Adjustments are applied on the go even during playback.

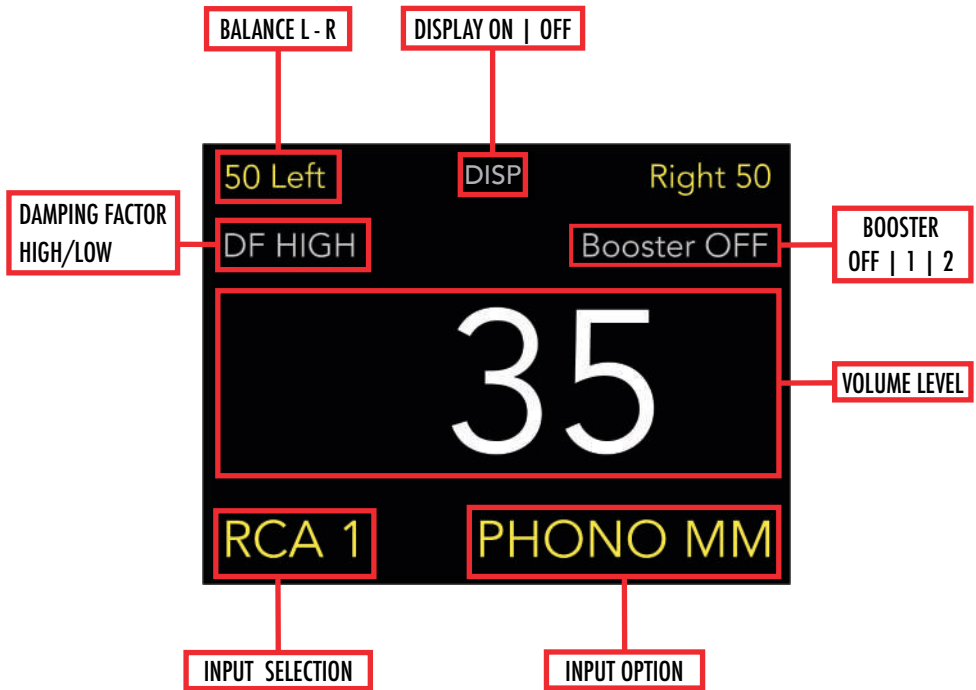

For further details about the features and the functions, please see page 17.

You will find a comprehensive guide to set and use IS-1000 in the most appropriate way in order to achieve the best audio performance with your loudspeakers and environment.

# QUICKSTART

## QUICKSTART GUIDE

IS-1000 is a Plug&Play source that simply requires only to be connected to the AC, the Internet and your speakers.

- 1 - connect IS-1000 to your speakers via the SPEAKER OUT connectors
- 2 - connect IS-1000 to your network via ETHERNET LAN or Wi-Fi (see page 15)
- 3 - connect IS-1000 to the AC using the supplied power cord
- 4 - connect other sources as a CD player or a turntable via XLR or RCA (see page 19)
- 5 - turn ON the master switch on the rear panel and then press and hold the knob for 3 seconds
- 6 - download the control App for iPhone, iPad and Android (see page 10)
- 7 - open the App [the smartphone/tablet must be connected to the same network used by IS-1000]

## IMPORTANT:

please ensure the unit is OFF while handling the cables and connectors

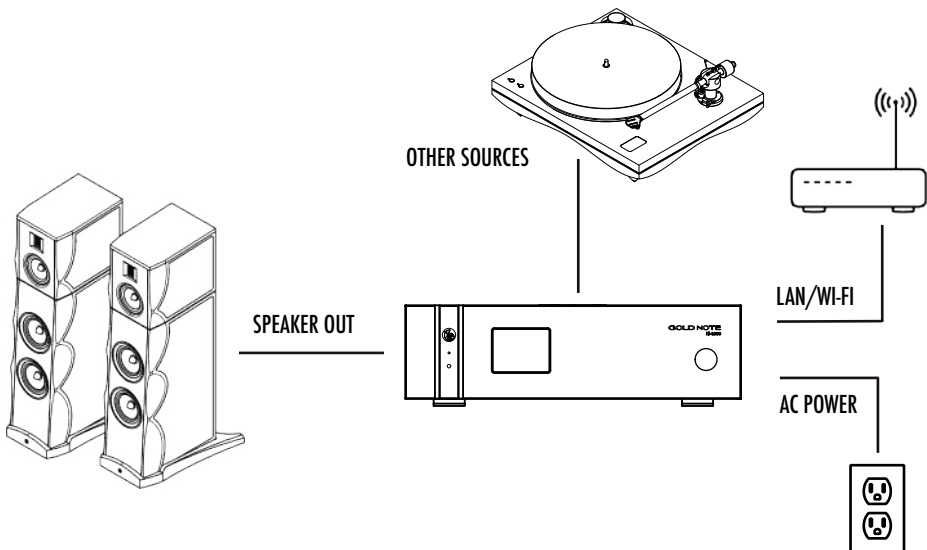

# CONTROL APP

## DOWNLOAD THE CONTROL APP

Available for free on iOS and Android, search for "GN Control" on the Apple App Store or Google Play Store.

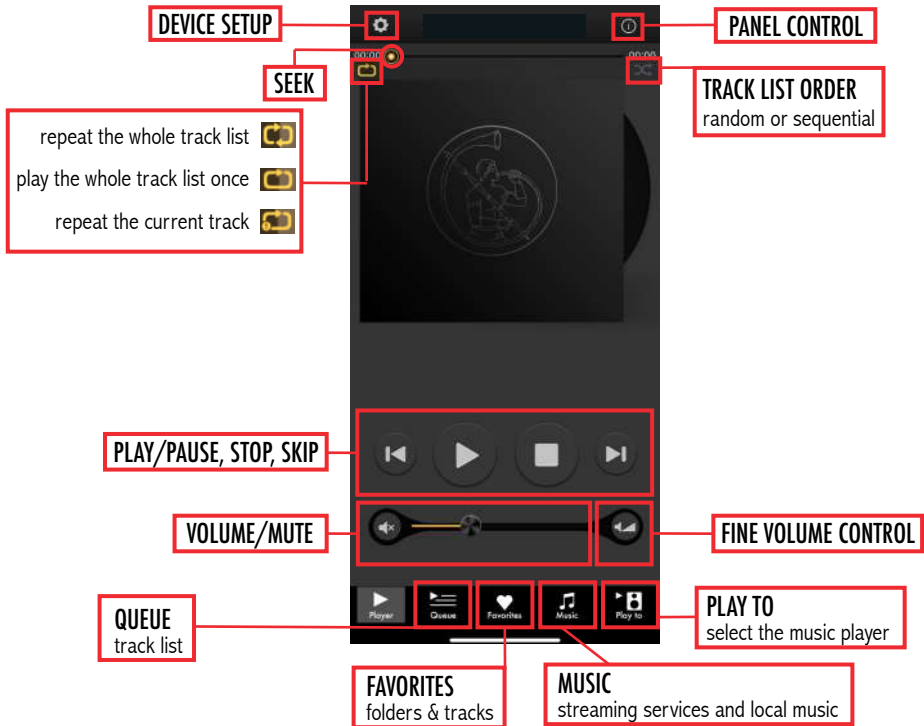
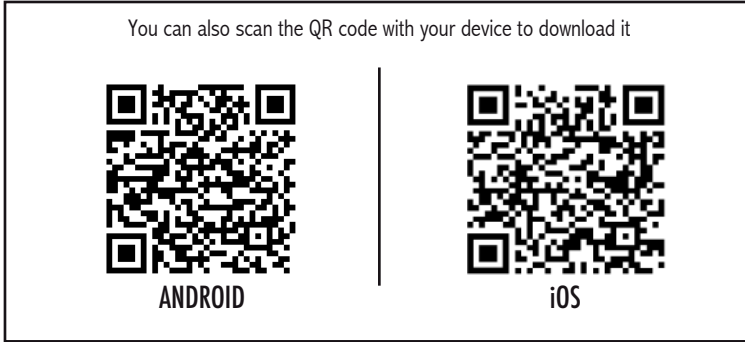

\*If you have the zoomed display on **iphone XR** please go to Setting - Display & Brightness - DISPLAY ZOOM and select Standard.

- Device Setup
- Cloud Setup
- Sort Tracks
- App Info

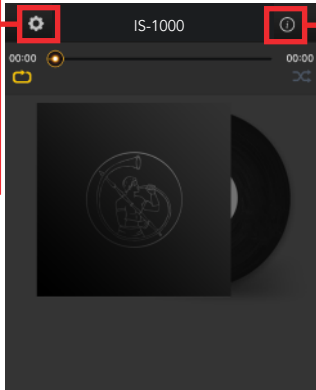

## PANEL CONTROL

Gapless playback is available here

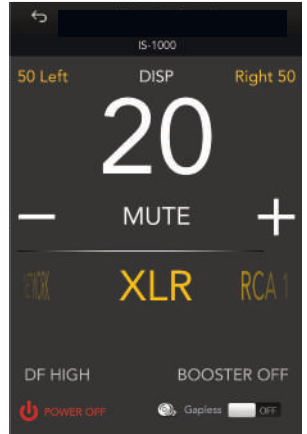

### WIFI NETWORK SELECTION

Connect the device to a different Wi-Fi network

### DEVICE NAME CHANGE

Rename the device on the network

### LAN STATIC IP ADDRESS SETUP

### WIFI STATIC IP ADDRESS SETUP

### FIRMWARE UPDATE

If there is a new firmware update available, the app notifies it

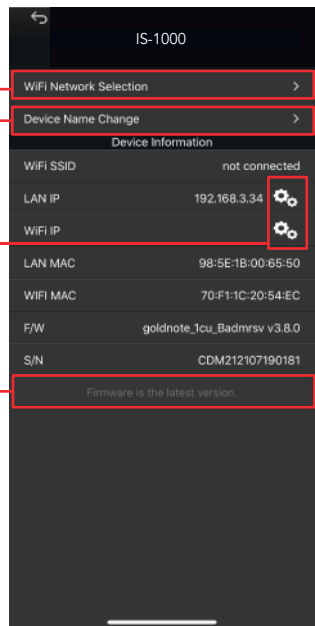

## CLOUD SETUP

In **CLOUD SETUP** you will be able to turn **ON/OFF** all the streaming services available on IS-1000 as:

**TIDAL** , **QOBUZ**, **DEEZER**, **VTUNER**. You will also be able to turn **ON/OFF** the cloud storage services as: **DROPBOX** and **ONEDRIVE**.

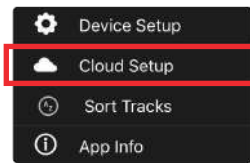

### CLOUD SETUP

enable and disable:

- STREAMING SERVICES
- CLOUD SERVICES

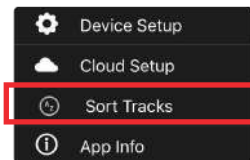
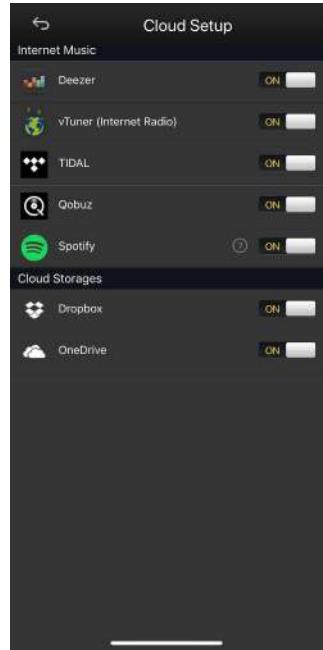

### SORT TRACKS

Music tracks in a folder can be sorted by track number and track name.

It can be applied even for each folder.

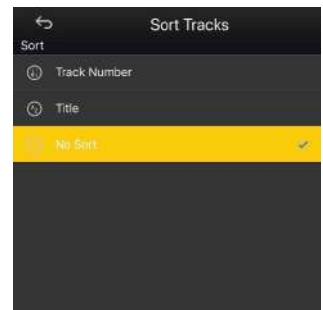

## PLAY TO AND MUSIC

### PLAY TO

Select the "Play To" tab and then select IS-1000.

Please be sure that the IS-1000 is connected to the same network the mobile device is using.

If the App doesn't show the IS-1000 it is most likely due to the fact the mobile device is connected to a different network than the IS-1000.

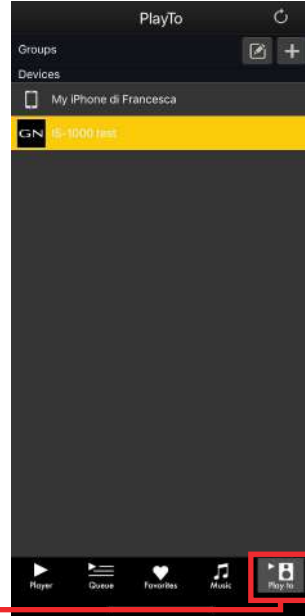

### MUSIC

In the "Music" tab choose the source of the music:

#### INTERNET MUSIC

Deezer | Qobuz | Spotify | TIDAL | VTuner

#### CLOUD STORAGE SERVICES

Dropbox | OneDrive

#### LOCAL SERVER

Network NAS and UPnP/DLNA services

USB flash drives are listed as "IS-1000 Server"

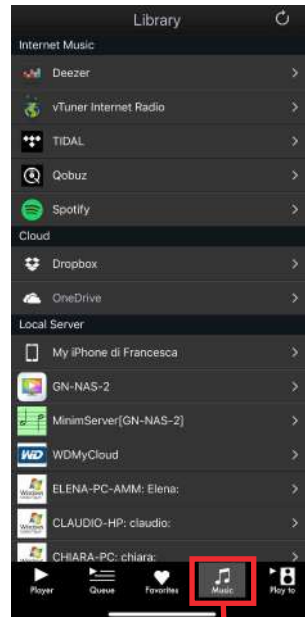

## CLOUD SETUP

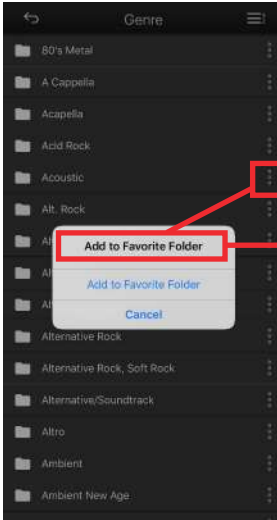

### FAVORITES

Use this button to add folders and tracks to your Favorites list.

The folder/tracks will be then listed in the Favorites tab.

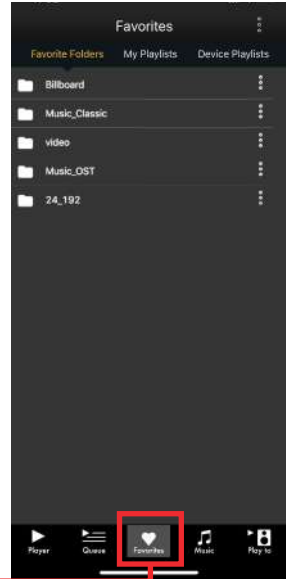

You can find the Favorites tab in the bottom menu.

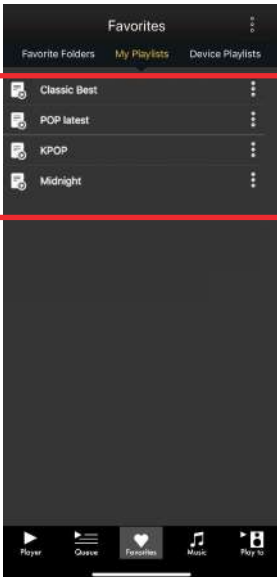

### MY PLAYLISTS

New playlists can be created using this button when you are in the My Playlist screen. Use this tab to manage your playlists, rename or delete them.

You can create a new playlist also while browsing music on Streaming services and local servers.

If you don't want to create a new Playlist, simply add the tracks to the playback **Queue**.

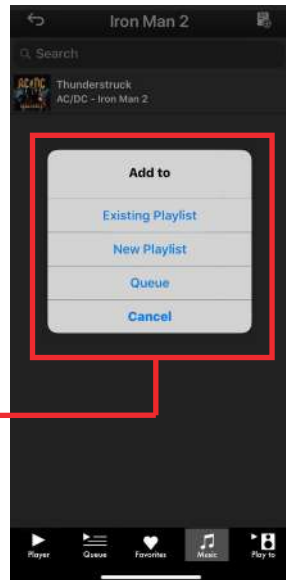

# NETWORK SETUP

## WLAN CONNECTION

IS-1000 supports both Wired LAN and Wi-Fi connection.

To use a Wired LAN connection simply plug the cable into the Ethernet port on the rear panel and you are ready to go.

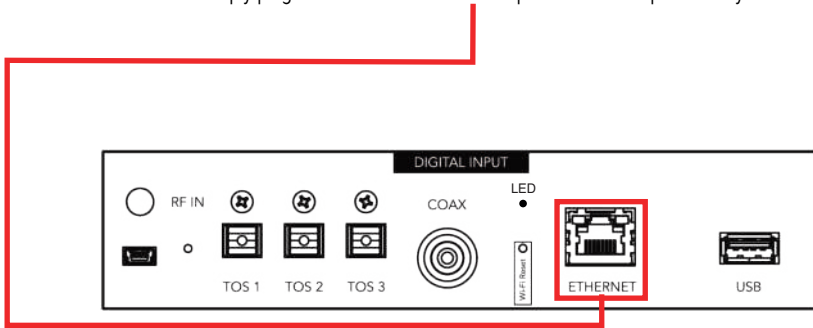

## WI-FI CONNECTION VIA WPS

The easiest way to connect IS-1000 to your network via Wi-Fi is to use the WPS [Wi-Fi Protected Setup] function available on IS-1000 and your router:

- 1 - use the tip of a paper clip to press and hold for about 10 seconds the Wi-Fi Reset button on the rear panel of IS-1000 and release it when the blue led start flashing
- 2 - press the WPS button on your router (please refer to the instruction manual)
- 3 - wait until IS-1000 automatically connect to your network
- 4 - the blue led will turn ON when the IS-1000 is connected and ready

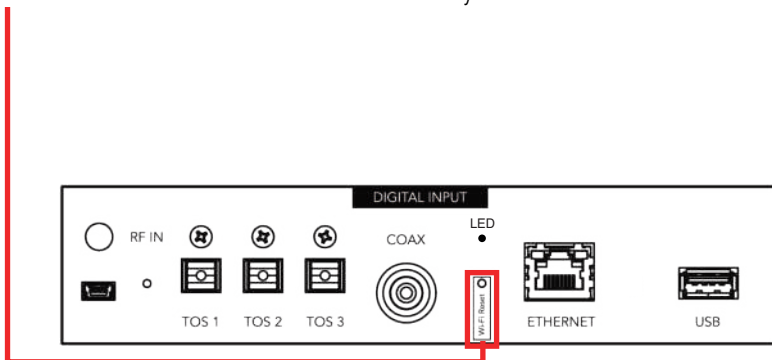



# NETWORK SETUP

## IS-1000 WIFI WIZARD MODE

In case your router doesn't support the WPS function or you can't access it, use the Wi-Fi Wizard Mode:

- 1 - to press and hold for 5 seconds the Wi-Fi Reset button on the rear panel of IS-1000 and release it when the blue led start flashing - IS-1000 will create its own wireless network.

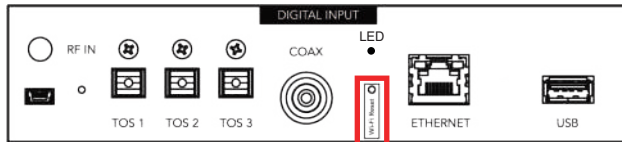

- 2 - turn ON the Wi-Fi on your mobile device and scan the networks to find GOLD-NOTE\_XXX
- 3 - connect to GOLD-NOTE\_XXX using "password" as password
- 4 - open the App and go into DEVICE SETUP > Wi-Fi Network Selection (see page 11)
- 5 - here are listed the wireless connections available, select the one you want to use with IS-1000
- 6 - IS-1000 is now connected to the selected Wi-Fi network
- 7 - connect your mobile device to the same network used by IS-1000

Mobile device screen



in App screen



in App screen

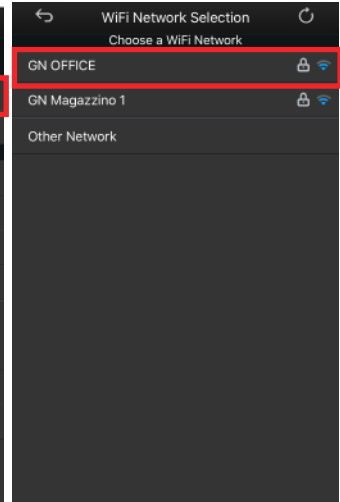

# IS-1000 FEATURES

## FEATURES AND FUNCTIONS

IS-1000 is an advanced integrated amplifier that we developed using proprietary technologies and features designed to offer the best audiophile sound quality but also to achieve ease of use and versatility in order to always deliver a great performance with a large variety of loudspeakers.

### BALANCE L/R

adjust the balance of the volume level on the Left and Right channel.

### DISP

turn the display ON or OFF when the display is OFF. Simply operate the knob or the remote to turn it ON again temporarily (timing is 3 seconds).

### VOLUME

the volume level is always displayed in the middle of the screen to be easily readable.

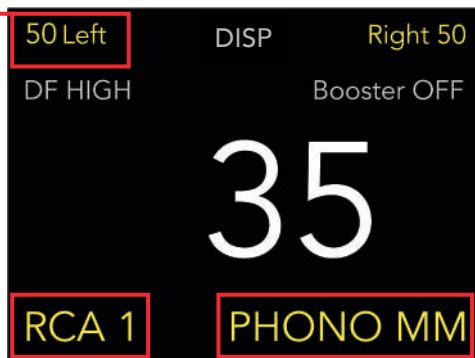

### INPUT SELECTION

**NETWORK** - select this input to use the streaming services and for music on local servers

**XLR** - balanced input to connect additional sources from your system, like a CD Player

**RCA 1** - input to connect additional sources or to use the built-in phono stage [select then PHONO MM/MC]

**RCA 2** - input to connect additional sources or to use the built-in [select then AV]

**TOS 1, 2, 3** - digital inputs to connect additional sources, like a TV etc.

**COAX** - digital inputs to connect additional sources, like a TV etc.

### DF - HIGH/LOW

the Damping Factor can be set on HIGH [250] or LOW [25] to drive properly any kind of speakers:

HIGH - gives the best of a solid state amp and it's an ideal match with big speakers of mid/low sensitivity.

LOW - is ideal to drive high-sensitivity speakers and mini-monitor as IS-1000 will act as a low-power tube amp.

### BOOSTER - OFF/1/2

The Booster is a feature designed to reproduce the lower range of frequencies with power and control. It works as a custom equalisation, increasing the gain around 50Hz to provide a richer and more full-bodied sound. The 50Hz frequency has been chosen since lower frequencies are more difficult to obtain with small speakers.

The Booster provides a richer and more full-bodied sound, for better realism and dynamic. It's particularly useful in case of speakers that require more energy in the bass frequencies, for night-time listening at lower volumes, or even to achieve a more realistic headroom. The Booster is completely by-passed when set to OFF, applied to 50% when set to 1, applied to 100% when set to 2.

# REMOTE CONTROL

## USING THE REMOTE CONTROL

IS-1000 is supplied with a Gold Note remote to help you conveniently operate the amplifier without even touching the knob located on the frontal panel.

With the remote control you can fully access every function just like you would when using the knob.

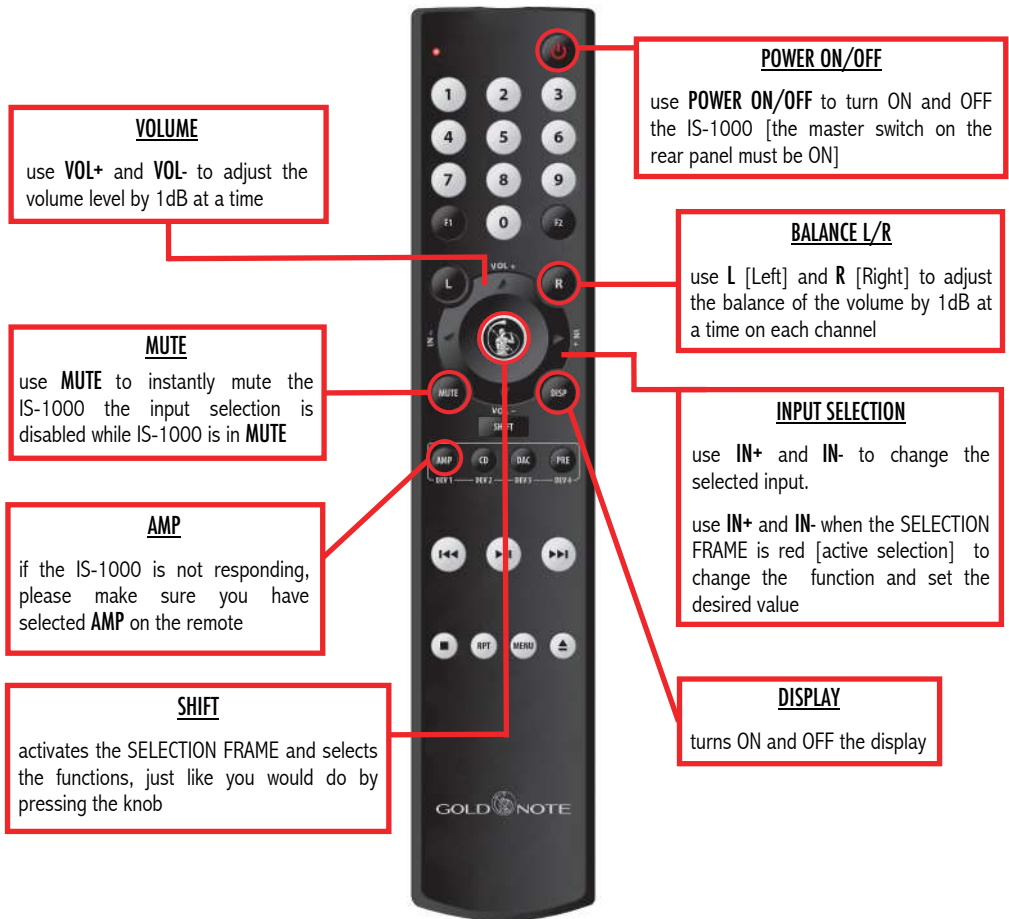

# CONNECTING OTHER SOURCES

## CONNECTING SOURCES VIA ANALOGUE INPUT

You can connect additional audio sources to IS-1000 via the analogue inputs located on the rear panel, using the unit as a pure Integrated Amplifier to power your system.

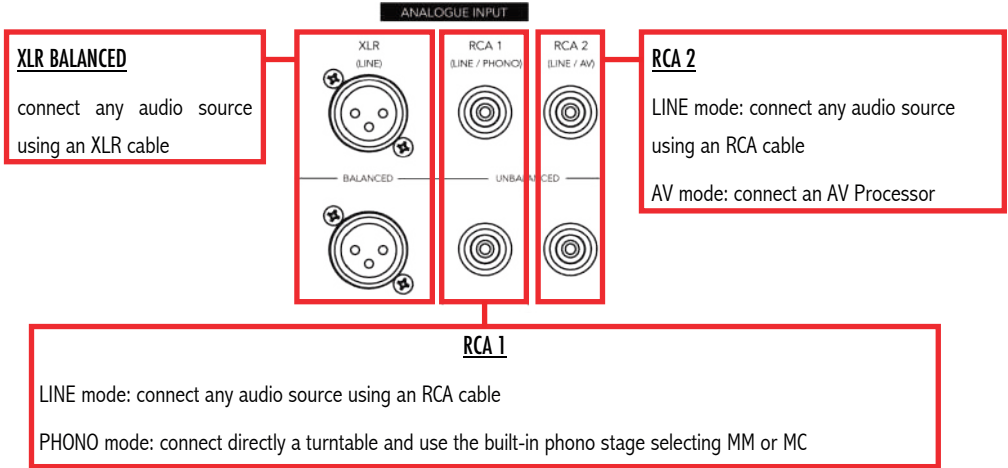

## CONNECTING SOURCES VIA DIGITAL INPUT

You can connect digital sources to IS-1000 using the digital inputs TOS and COAX located on the rear panel

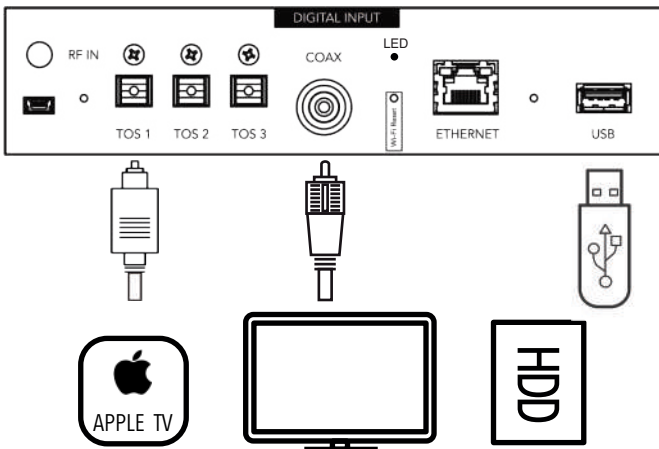

# IMPORTANT NOTES FOR MCONNECT CONTROL ONLY

## PLEASE NOTE

The **WiFi Interface** must remain **ON** to control IS-1000 via App, disabling it will cause the IS-1000 to be impossible to reach via App even when using a cabled connection (LAN via Ethernet).

The **WiFi Interface** allows the connection between the App and the IS-1000 so we recommend to always keep it ON.

If you are using IS-1000 in wireless mode (connected via Wi-Fi) and wish to switch to cabled mode (LAN) simply connect the Ethernet cable using the dedicated port available on the rear panel of IS-1000.

Once the cable is connected, IS-1000 will automatically switch mode and disable the Wi-Fi connection.

Wait for the blue LED located on the rear panel to turn OFF for confirmation that IS-1000 is using the LAN.

To return to Wireless mode after connecting the Ethernet cable, you need to reset the Wi-Fi system as described on [page 15](#).

## PLEASE LEAVE THE WIFI INTERFACE ON AT ANY TIME

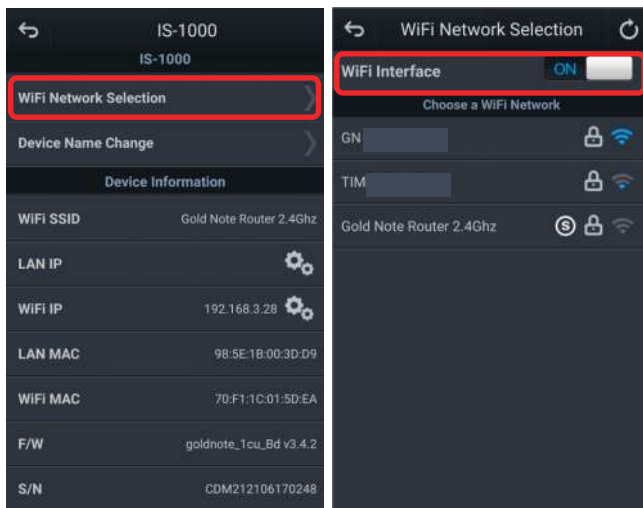

### IN CASE WIFI INTERFACE IS ACCIDENTALLY SWITCHED OFF

To enable the remote control via App you will need to switch the WiFi Interface ON again.

Please follow the procedure explained at [page 16](#) "IS-1000 WiFi WIZARD MODE" to enable it and then connect IS-1000 to your WiFi network.

# WARRANTY

## PRODUCT REGISTRATION

We recommend to register the unit on our internet website within 15 days from the purchase at

[www.goldnote.it/product-registration](http://www.goldnote.it/product-registration)

If the unit is not registered correctly or has been purchased from a different country of the purchaser home address the unit will not be covered by any warranty and the registration will be refused.

Please note that the warranty does not cover in any case: Tubes, Phono Cartridge Stylus and Batteries.

## WARRANTY

All Gold Note products come with a warranty against defective materials and workmanship.

Any service and inspection must be carried out by a Gold Note dealer or distributor so in case you need any assistance with this product, please contact the seller.

If you experience any problems locating your official Gold Note dealer or distributor, please check our website.

## PLEASE NOTE

Descriptions and technical characteristics may vary at any time and without notice.

## WARNING

Gold Note products should only be opened, serviced and inspected by certified Gold Note technicians and dealers.

Work performed by unqualified personnel may cause serious damage or personal injury. Opening of the product by non-authorized personnel will void the guarantee. In this case, contact your dealer to be advised on how the fault can be solved.

Do not return any object directly to the factory or to the distributor without being authorised to do so.

PROBLEM	CAUSE	SOLUTION
The GN remote doesn't control the IS-1000	<p>The GN remote can be used to control more than one unit.</p> <p>To control each unit the correct mode must be selected on the remote.</p>	<p>Select AMP mode on the remote.</p> <p>The button "AMP" is located in the upper part of the remote.</p> <p>See page 18 for more information.</p>
The App can't find the IS-1000 in the network	The IS-1000 is not connected to the network.	<p>Make sure the IS-1000 is connected to the WLAN or LAN either with the Ethernet cable or the Wi-Fi.</p> <p>See page 15 for more information.</p>
		<p>Make sure the RF antenna is correctly installed.</p> <p>It may be impossible to use the IS-1000 with the Wi-Fi if the RF antenna is not installed.</p>
		<p>When using Wi-Fi, make sure the IS-1000 is connected to the correct WLAN. Don't forget to put in the password to complete the connection if required by your network setup.</p>

If you have any questions contact us:

[service@goldnote.it](mailto:service@goldnote.it)

For spare parts visit the official Gold Note store at:

[www.akamaiaudio.it](http://www.akamaiaudio.it)

# IMPORTANT SAFETY INFORMATION



**CAUTION**  
RISK OF ELECTRIC SHOCK  
DO NOT OPEN



## CAUTION!

TO REDUCE THE RISK OF ELECTRIC SHOCK, DO NOT REMOVE COVER (OR BACK). NO USER-SERVICEABLE PARTS INSIDE. REFER ONLY TO QUALIFIED GOLD NOTE SERVICE PERSONNEL FOR SERVICE



**WARNING**  
FIRE OR SHOCK HAZARD



## WARNING!

TO PREVENT FIRE OR SHOCK HAZARD, DO NOT EXPOSE THIS APPLIANCE TO RAIN OR MOISTURE

Do not disassemble any part of the product.

Do not use any part of the product for other purposes.

For service and problems of any kind, contact qualified Gold Note personnel.

Protect the product from rain, humidity and keep away from heat sources, electric and electronic motors etc.

The power Chord supplied must be used only on this unit.

Gold Note does not have responsibility for any improper use of this unit.

This appliance has a serial number located on the rear panel.

Please record the model and serial number and retain them for your records.

Serial Number: \_\_\_\_\_

Model: \_\_\_\_\_



# IMPORTANT SAFETY INFORMATION

1. Read these instructions and store them.
2. Heed all warnings.
3. Follow the instructions.
4. Do not use this apparatus near water.
5. Clean only with a dry cloth.
6. Do not block the ventilation openings and install in accordance with the manufacturer's instructions.
7. Do not install near heat sources such as radiators, heat registers, stoves or other apparatus (including amplifiers) that produce heat.
8. Do not defeat the safety purpose of the polarised or grounding-type plug: a polarised plug has two blades with one wider than the other.

A grounding type plug has two blades and a third grounding prong. The wide blade or the third prong are provided for your safety.

If the provided plug does not fit into your outlet, consult an electrician for replacement of the obsolete outlet.

9. Protect the power cord from being walked on or pinched particularly at plugs, convenience receptacles, and the point where they exit from the apparatus.
10. Only use attachments/accessories specified by the manufacturer.

11. Use only with the cart, stand, tripod, bracket, or table specified by the manufacturer, or sold with the apparatus.

When a cart is used, use caution when moving the cart/apparatus combination to avoid injury from tip-over.

12. Unplug this apparatus during lightning storms or when unused for long periods of time.

13. Refer all servicing to qualified service personnel only. Servicing is required when the apparatus has been damaged in any way (such as when the power cord or plug is damaged, liquid has been spilled or objects have fallen into the apparatus, the apparatus has been exposed to rain or moisture) and in any case when the apparatus does not operate normally or has been dropped.







 [goldnote\\_italy](https://www.instagram.com/goldnote_italy)

 [Gold Note Audio](https://www.facebook.com/GoldNoteAudio)

 [Gold Note](https://www.youtube.com/GoldNote)

Akamai S.r.l.  
[service@goldnote.it](mailto:service@goldnote.it)  
[www.goldnote.it](http://www.goldnote.it)