

Audionet

DNC

Digital Network Client

User's Manual

Contents

1	Preface	7
1.1	Included	8
1.2	Transport	8
2	Overview front panel	9
3	Overview back panel	10
4	Installation and power supply	11
4.1	Placement	11
4.2	Mains connection	11
4.3	Orientation of mains plug	12
5	Inputs and outputs	13
5.1	Audio inputs	13
5.1.1	Digital input	13
5.1.1.1	Audionet HighBit input	13
5.2	Audio output	14
5.3	Other connections	14
5.3.1	Network, USB, WLAN	14
5.3.2	USB Audio	15
5.3.3	FM Antenna Connection	15
5.3.4	Audionet Link	15
5.3.5	External power supply EPS G2 or EPX	16
5.3.6	Additional earth connection	17
5.3.7	Control connections	17
6	Usage	18
6.1	Basic operations	18
6.1.1	Powering up	18
6.1.2	Switching on and off	18
6.1.3	Mains phase detection	19
6.1.4	Using Audionet Link	20
6.1.5	Control elements on the front panel	20
6.2	Detail operations	22
6.2.1	Display	22
6.2.1.1	Digital input channel	22
6.2.1.2	FM tuner	22

6.2.1.3	NET input.....	23
6.2.2	Input selection	25
6.2.3	FM tuner	25
6.2.4	NET input.....	26
6.2.4.1	Internet radio	26
6.2.4.2	USB.....	27
6.2.4.3	UPnP server.....	27
6.2.5	USB Audio	27
7	Audionet Metal Remote Control RC 2.....	28
7.1	Key Assignment RC 2	29
7.2	Changing the batteries	30
7.3	Settings for Audionet DNC	30
8	Device setup.....	32
8.1	Overview device menu	33
8.2	Global setup	34
8.2.1	Select Input.....	34
8.2.2	Display.....	35
8.2.3	Auto start	36
8.2.4	Power-off mode	37
8.2.5	Serial Port.....	38
8.2.6	Channel name	39
8.2.7	Digital Equalizer.....	40
8.2.8	Digital equalizer setup.....	40
8.2.9	Trigger out.....	42
8.2.10	Speaker distance	43
8.3	Network setup.....	44
8.3.1	Manage Network	45
8.3.1.1	Restart Network Driver.....	45
8.3.1.2	Save & Apply Settings	46
8.3.1.3	Load Factory Defaults.....	46
8.3.2	Connection Type	47
8.3.3	DHCP	47
8.3.4	IP Address	48
8.3.5	IP Mask.....	49
8.3.6	Gateway.....	50
8.3.7	DNS.....	50
8.3.8	RCP port.....	51
8.3.9	Wireless setup.....	52

8.3.9.1	SSID	53
8.3.9.2	Wireless security	53
8.3.9.3	WPA pass phrase.....	54
8.3.9.4	WEP authentication.....	55
8.3.9.5	WEP key index.....	55
8.3.9.6	WEP key 0-3	56
8.3.10	Example for Network setup.....	57
8.4	Factory Default Reset.....	61
8.5	User settings	62
8.5.1	Save user setting.....	63
8.5.2	Load user setting.....	63
8.6	Device info	64
9	Additional information	65
9.1	Glossary.....	65
9.2	Link collection.....	67
9.2.1	Wireless security	67
9.3	Equalizer filter type.....	68
9.3.1	Peak-Filter	68
9.3.2	High shelf filter.....	68
9.3.3	Low shelf filter	68
9.3.4	High-pass filter 2 nd order	69
9.3.5	Low-pass filter 2 nd order.....	69
9.3.6	High-pass filter 1 st order.....	69
9.3.7	Low-pass filter 1 st order.....	69
9.4	Error handling (FAQ).....	70
9.5	Security advice	71
9.6	Factory defaults	72
9.7	Specifications.....	73

1 Preface

The Audionet Team congratulates you on your purchase of this unit.

Audionet components are no marketing products, they are authentic. Conceived and developed with scientific inspiration, professional engineering expertise and a passion for achieving the perfect sound. They are unique creations designed to inspire musical enjoyment and have an excellent reputation amongst all connoisseurs throughout the world. Each and every one of our precision-manufactured devices is individually crafted at our Berlin works by our experienced and passionate workforce.

But before you start listening to your new Audionet DNC, please read this manual carefully so you are able to use and enjoy all functions of this unit without drawback on music quality.

1.1 Included

Included you will find the following items:

- The network client DNC
- The user's manual
- One standard mains cord
- F-adaptor for FM connection
- WLAN antenna
- Audionet Metal Remote Control *RC 2*

1.2 Transport



Important

- Please transport the DNC only in the included package.
- Always use the provided cloth bag to prevent scratches on the casing
- Please allow the DNC to adapt to the climatic conditions in your listening room before you switch on the unit for the first time after transport.

2 Overview front panel

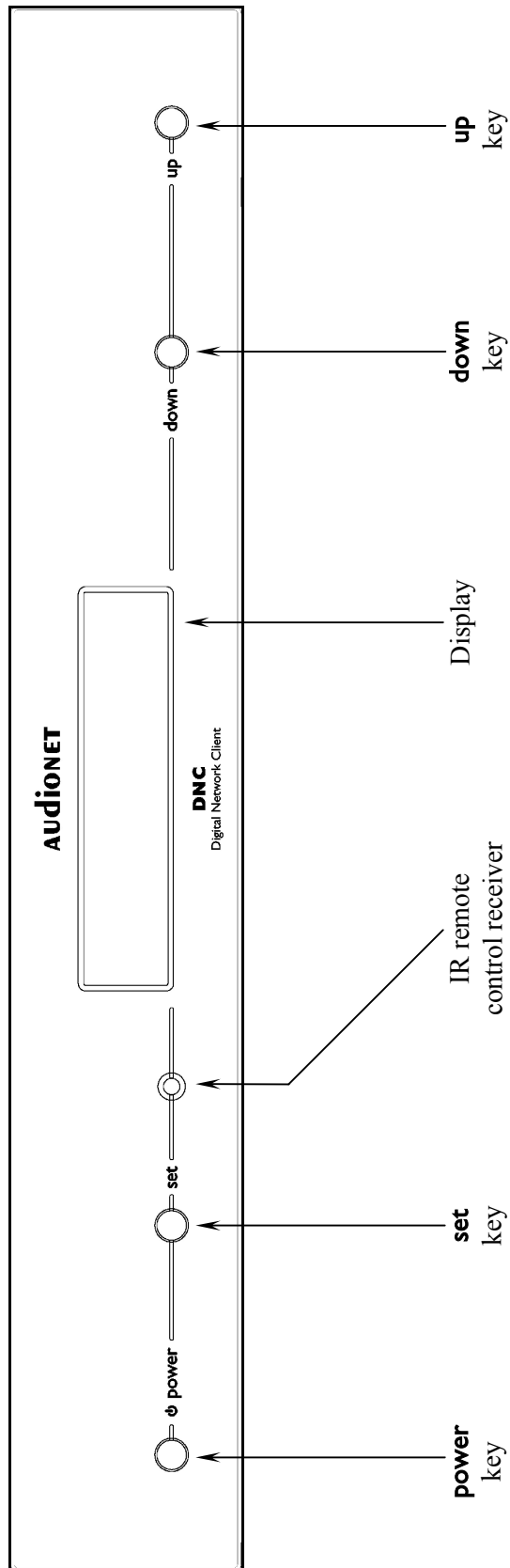

3 Overview back panel

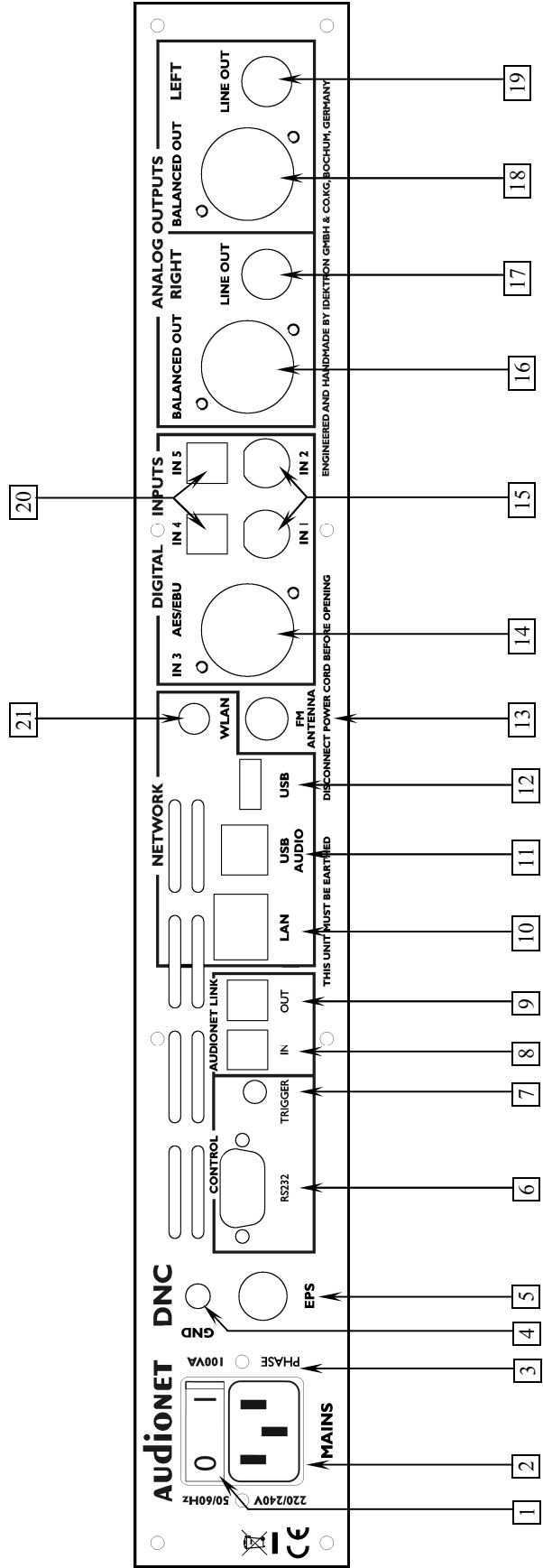

- 1 Mains switch
- 2 Mains input
- 3 Marking mains phase
- 4 additional earth connector
- 5 5-pin connector for external power supply EPS
- 6 Serial control port RS232
- 7 Trigger output (5 or 12 Volt)
- 8 Audionet Link input IN
- 9 Audionet Link output OUT
- 10 Ethernet connector LAN
- 11 USB Audio Input
- 12 USB input
- 13 FM antenna input
- 14 Digital input no. 3, AES/EBU (XLR)
- 15 Digital input no. 1, no. 2, electrical
- 16 Balanced output (XLR), right
- 17 Unbalanced output (Cinch), right
- 18 Balanced output (XLR), left
- 19 Unbalanced output (Cinch), left
- 20 Digital input no. 4, no. 5, optical
- 21 Connector WLAN antenna

4 Installation and power supply



Important

- **During connecting and removing of sources or amplifiers to the DNC all units of your audio system have to be switched off to prevent damage of the DNC or any of the other connected units.**
- **Please make sure that all cables are in absolute best conditions! Broken shields or short-cut cables could damage the DNC and/or any other connected unit.**

4.1 Placement



Important

- It is recommended to place the DNC into a high quality rack or onto a stable table.
- Do not expose the unit to direct sunlight.
- Do not cover the ventilation slots.
- Do not place the DNC in close range to heat sources like radiators.
- Do not place the DNC on top of other units, especially not on top of power amplifiers, preamplifiers or similar devices that produce heat. Both units could suffer damage from thermal overload.
- Do not place other units on top of the DNC. Both units could suffer damage from thermal overload.
- Do not use the unit in places where it is exposed to vibrations.
- Do not place the unit close to loudspeakers or into the corner of a room where it is exposed to high levels of sonic energy, which might reduce the sound quality of the unit.

4.2 Mains connection

The mains input 2* is on the back panel of the DNC. To connect the device to mains use the included mains cord. If you prefer to use a different power cord, make sure that it meets the specifications for your home country.

*see numbers in section "3 - Overview back panel" on page 10.



Important

- **The electrical specifications of your home country must meet the electrical specifications printed onto the back panel.**
- The DNC is a Class I unit and must be earthed. Please ensure a stable earth connection. Phase (hot pin) is marked on the back panel **phase** [3].
- If you connect the mains cord please make sure that the mains switch [1] on the back panel is switched off.
- Never pull the mains plug while the DNC is switched on! Before you pull the mains cord off its socket [2] on the back panel, power down the unit to stand-by mode using **power** key, and switch off the unit using mains switch [1].

Only in cases of extended absence – like vacations – or if massive trouble on the mains power grid is to be expected you should switch off the DNC from the mains using mains switch [1]. Then, to disconnect the unit completely from mains power grid, pull the mains plug.



Tip

- The use of high quality mains cords can improve sound quality. Ask your local dealer for more information.

4.3 Orientation of mains plug

The correct polarization of mains is important for reasons of audio clarity and stability. Please connect the mains cord so that the hot pin of the wall outlet is connected to the pin of the mains input [2] marked **phase** [3]. Your Audionet DNC is able to detect a wrong polarization of the mains plug during start-up. If the message

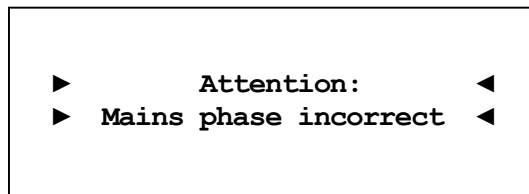

appears in the display, switch off the unit and flip the mains plug in the wall outlet (see section "*6.1.3 - Mains phase detection*" on page 19).

5 Inputs and outputs



Important

- During connecting and removing sources or amplifiers to the DNC all units of your audio system have to be switched off to prevent damage of the DNC or any of the other connected units.
- Please make sure that all cables are in absolute best conditions! Broken shields or short-cut cables could damage the DNC and/or any other connected unit.

5.1 Audio inputs

5.1.1 Digital input

Connect your digital sources to the electrical (coaxial) digital input **IN 1** and **IN 2** [15]* or to the optical (TosLink) digital input **IN 4** and **IN 5** [20]. In addition, there is a XLR socket **IN 3 AES/EBU** [14] for connecting AES/EBU input signals.



Note

- Please make sure that your digital sources provide only uncompressed stereo PCM data to the digital inputs of your DNC. Possibly, other unsuitable formats (e.g. Dolby Digital or DTS data streams etc.) could cause noise.

5.1.1.1 Audionet HighBit input

In order to send audio data across the Audionet HighBit interface to your DNC, connect your source device (e.g. ART G3 or VIP G3) with **two** digital cords to the digital inputs **IN 1** and **IN 2**.

The following table shows how to connect Audionet HighBit-capable devices to the DNC:

Audionet HighBit			
Devices	Output		DNC Input
VIP G3	Digital OUT 1	→	Digital IN1
	Digital OUT 2	→	Digital IN2
ART G3	Digital OUT 1	→	Digital IN1
	Digital OUT 2	→	Digital IN2

*see number in section "3 - Overview back panel" on page 10.



Important

- Only if **both** connections are established and Audionet HighBit mode is activated on your source device, you can transmit audio data with all sampling rates and full resolution.



Note

- Check the corresponding section in user's manual for Audionet ART or VIP. User's manuals are available for download on our website www.audionet.de.

5.2 Audio output

The DNC is equipped with two pairs of analog outputs: **BALANCED OUT** 16 and **LINE OUT** 17 for the right channel, and **BALANCED OUT** 18 and **LINE OUT** 19 for the left channel.

5.3 Other connections

5.3.1 Network, USB, WLAN

The Ethernet port **LAN** 10 is a standard RJ45 socket for network cables (Cat-cable, 10/100 Mbit BASE-T).

The WLAN port **WLAN** 21 uses a SMA connection to attach the provided WLAN antenna. With the articulated joint the antenna can be turned into two directions.

The USB port **USB** 12 is a TYPE-A socket (USB 2.0) for external hard drive, USB sticks etc.



Note

- We recommend using a wired network connection for best data transfer rate and to provide high stability in control with our software.

5.3.2 USB Audio

The USB Audio port **USB AUDIO** [11] is a USB TYPE-B-socket. With the USB Audio connection, you are able to connect your DNC with a USB cable directly to a PC. Thus, you can use your DNC as the sound device / playback device for your PC. Playback operates in asynchronous mode, that means the DNC uses its own clock and you are able to enjoy your music without diminishing sound quality.

For using USB Audio, the required driver needs to be installed on your PC. For Apple devices using Mac OS X 10.6.4 and higher a suitable driver is included within the operating system. To receive the driver for Windows based systems please contact us via service@audionet.de.



Note

- The driver is packed into a zip-file. To install the driver unpack the zip-file into a folder of your choice. Then open the chosen folder and start the installation process executing the file *setup.exe*.
- During the installation process, all occurring security warnings can be confirmed with 'OK'.
- During the installation process, your Audionet device has to be connected with your PC via an USB cable.
- After successful installation, you can choose your DNC as the sound device / playback device of your PC. For configuration, open the system preferences of your PC.
- Pay attention to the length of the USB cable. If the cable is too long, you might diminish sound quality and / or experience dropouts during playback.

5.3.3 FM Antenna Connection

Your device has an F-series connector [13] for antenna connection. An adaptor to coaxial socket is delivered separately. This port is specified for 75 Ohm FM antenna or analog cable TV connection.

5.3.4 Audionet Link

For your convenience, the DNC can be switched on/off by other Audionet units (e.g. preamplifiers) connected via Audionet Link by a simple touch on the remote control or the **power** key on the front panel.

You need just a simple optical TosLink cable. Connect the Audionet Link input **Link IN** [8] of your DNC to the Audionet Link output of the controlling unit.

The DNC is equipped with an Audionet Link input **Link IN** [8] and an Audionet Link output **Link OUT** [9]. The DNC is a slave device. Connect the Audionet master device to **Link IN** [8], other Audionet slave devices can be connected to **Link OUT** [9]. Thus, the switching signal will be passed along.



Tip

- Audionet source units and power amplifiers are usually equipped not only with an Audionet Link input, but also with an Audionet Link output to connect further Audionet devices to be controlled via Audionet Link in a daisy chain. Connect this Audionet Link output to the Audionet Link input of the next Audionet unit using a simple optical TosLink cable allowing you to switch on/off your complete Audionet system by your Audionet master unit.



Important

- For the DNC to be controlled via Audionet Link, menu item **Power-off mode** within the **Global Setup** menu has to be set to **Quick Start** (see section 8.2.4 - *Power-off mode on page 37*).

5.3.5 External power supply EPS G2 or EPX

In order to use the optional external power supply Audionet EPS G2 or Audionet EPX connect it with the delivered cable to socket **EPS** [5] on the back panel of your DNC. Connect **both (!) units** (DNC and EPS G2 / EPX) to mains. First, switch on the DNC with the mains switch [1] on its back panel. Then switch on the EPS / EPX. Now the DNC is ready to use (stand-by mode).

Switch on the DNC with the **power** key on the front panel or key **DNx** of the Audionet Metal Remote Control RC 2. The Audionet EPS G2 / EPX will then be automatically switched on time-delayed.

To disconnect the DNC and EPS G2 / EPX from mains, switch the DNC into stand-by mode. Use the **power** key on the front panel or the key **DNx** on the Audionet Metal Remote Control RC 2. First, switch off the DNC with the mains switch [1] on the back panel, and then switch off the EPS G2 / EPX. Now you may disconnect the mains and EPS G2 / EPX connection cables.



Important

- **Never switch on or off the EPS G2 / EPX on its back panel while the DNC is operating!**
- **The DNC is only to be used with EPX or with EPS G2 from serial number 12.23.10 on up. For EPS or EPS G2 with older serial numbers there is no guarantee for proper functionality!**

- Before using the DNC in combination with the external power supply EPS G2 or EPX please read the user's manual of the EPS G2 or EPX carefully!

5.3.6 Additional earth connection

An optional green-yellow cord for the additional earth connection is available from Audionet. Attach this cord to the earth connector [4] on the back panel of the DNC and put the plug into the mains socket right beside the mains cord of your DNC. This ensures an additional and stable earth connection resulting in a better sound.

5.3.7 Control connections

Use trigger output **TRIGGER** [7] to control (e.g. switch on/off) non Audionet devices. If you switch on the DNC from stand-by mode, the trigger output [7] provides a signal of 12 Volts DC (see section "**8.2.9 - Trigger out" on page 42**), which can be re-configured to 5 Volts DC.

The serial connection **RS232** [6] is an additional control port to your DNC e.g. for house automation systems (Crestron or the like). The documentation to the interface protocol is available on request. Please send us an email to address service@audionet.de.



Tip

- Use a 3.5 mm telephone mono plug to connect a device to the trigger output [15] of your DNC. The pinning is as follows:

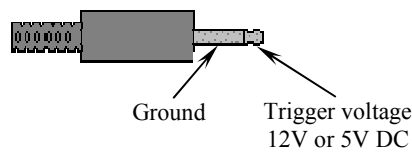

6 Usage



All functions of the DNC are microprocessor controlled. This guarantees highest precision, exclusive functions, easy handling and protection against operating errors.

6.1 Basic operations

6.1.1 Powering up

First of all, please make sure your DNC is connected correctly to your signal sources, preamplifier(s) and mains (see section *"4 - Installation and power supply"* on page 11 and *"5 - Inputs and outputs"* on page 13).

The DNC is a stand-by unit. Please operate the mains switch  on the back panel. The display shows a welcome message for a brief moment. After that the DNC is in stand-by mode.

Only in cases of extended absence (like vacations) or if massive trouble on the mains power is to be expected (e.g. thunderstorms) it is recommended to disconnect the DNC from the mains. While the DNC is in stand-by mode, operate mains switch  on the back panel. The display will go dark. To disconnect the DNC from mains completely, you have to pull the mains cord off the mains jack .



Important

- **Before you switch off the DNC from mains, power down and discharge completely all units connected to the outputs of the DNC.**

6.1.2 Switching on and off

To power up the DNC from stand-by mode, press the **power** key on the front panel. The DNC issues the message:

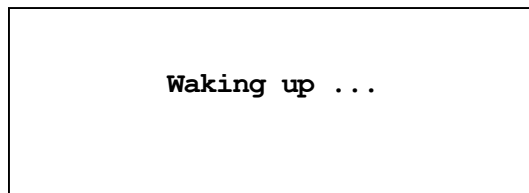

In case the mains plug has the incorrect polarization a warning will appear in the display (see section *"4.3 Orientation of mains plug"* on page 12). After that, the unit is in normal operating mode and ready to use.

If you would like to switch off the unit, please press the **power** key on the front panel. The display shows the message

Going to sleep ...

and the unit enters stand-by mode.



Note

- Of course, you may switch on/off the DNC with the Audionet Metal Remote Control *RC 2*. For detailed information please refer to section "*7 - Audionet Metal Remote Control RC 2*" on page 28.

6.1.3 Mains phase detection

The correct polarization of mains is important for reasons of audio clarity and stability. Please align the mains cord so that the hot pin of the wall outlet is connected to the pin marked **phase** 3 of the mains input 2 on the back panel. The DNC recognizes the incorrect polarization of the mains plug automatically. Right after switching on the unit from stand-by mode by pressing the **power** key on the front panel the following message will appear in the display in case the mains polarization is incorrect:

▶ **Attention:** ◀
▶ **Mains phase incorrect** ◀

If you got the above message, switch off the unit by pressing the **power** key. Please wait until the display no longer reads:

Going to sleep ...

Disconnect the DNC from mains by operating the mains switch 1. Now pull the mains plug and re-insert it into the mains socket rotated by 180°.

If you switch on the unit again, the warning should not appear now.



Important

- If the DNC issues the mains polarization warning or no warning at all for both positions of the mains plug, check the connection to earth of your mains socket and mains cord. **You have to ensure a stable**

connection to earth for the mains phase detection of the DNC to work correctly!

6.1.4 Using Audionet Link

The DNC is equipped with an Audionet Link input **Link IN** [8] and an Audionet Link output **Link OUT** [9] allowing you to connect further Audionet units (e.g. preamplifiers, power amplifiers or CD player) via Audionet Link (also see section "*5.3.4 - Audionet Link*" on page 15).

If the rest of your Audionet system is connected to your DNC via Audionet Link, all units connected to the Audionet Link output **Link OUT** [9] will be automatically switched on/off as soon as the DNC itself is switched on/off via **Link IN** [8].



Note

- Please read section "*5.3.4 - Audionet Link*" on page 15. Also, consult the user's manual of your Audionet components connected via Audionet Link for further information.
- If you use Audionet Link to switch off other devices, please wait until everything is in stand-by mode before you switch on again.



Important

- For the DNC to be controlled via Audionet Link, menu item **Power-off mode** within the **Global Setup** menu has to be set to **Quick Start** (see section *8.2.4 - Power-off mode on page 37*).

6.1.5 Control elements on the front panel

The front panel has four keys to control the DNC (see section "*2 - Overview front panel*" on page 9). With these keys you are able to control all functions as well as all setup options to adjust the unit to your preferences (see section "*8 - Device setup*" on page 32).

power Use key to switch on/off the unit (see section "*6.1.2 - Switching on and off*" on page 18).

set Push key for less than 2 seconds to change input channel (see section "*6.2.2 - Input selection*" on page 25). Within a menu, press **set** shortly to open a subfolder or to confirm and save an adjustment.
Push the key for longer than two seconds to get into system menu (see section "*8 - Device setup*" on page 32). Within a menu, press and hold for longer than 2

seconds to step back to the parent folder or to dismiss an adjustment without saving.

down

Push key to select previous input channel (see section *"6.2.2 - Input selection" on page 25*) or change an option of the setup menu (see section *"8 - Device setup" on page 32*).

up

Push key to select next input channel (see section *"6.2.2 - Input selection" on page 25*) or change an option of the setup menu (see section *"8 - Device setup" on page 32*).

6.2 Detail operations

6.2.1 Display

The display provides the following information in the normal operating mode.

Depending on which input channel you chose, you get different information. If there is more information to show you can switch display pages with the keys ◀ / ▶ on the Audionet Metal Remote Control *RC 2* (see section "*7.1 - Key Assignment RC 2*" on page 29). You will need it especially for the NET input channel (see section "*6.2.1.3 - NET input*" on page 23). The following illustrations demonstrate the differences between the input channels. Your display could look different, because of your selected system setup.

6.2.1.1 Digital input channel

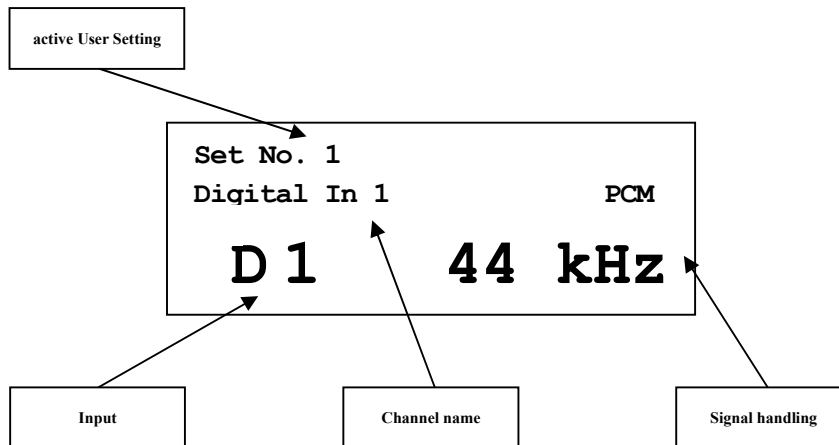

6.2.1.2 FM tuner

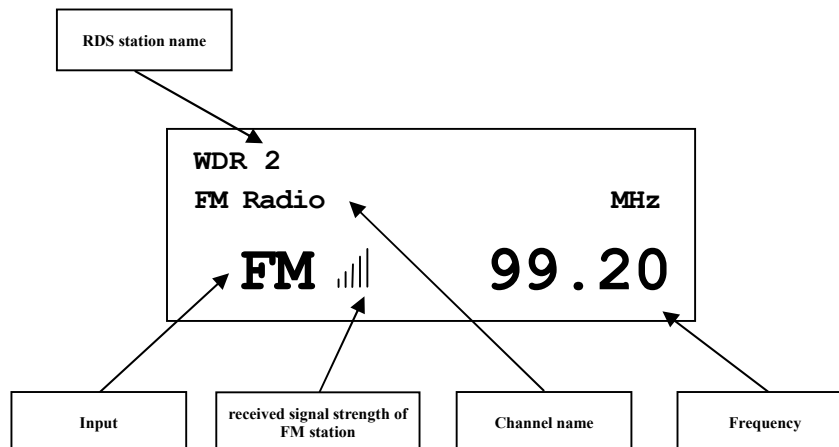

6.2.1.3 NET input

- View 1:

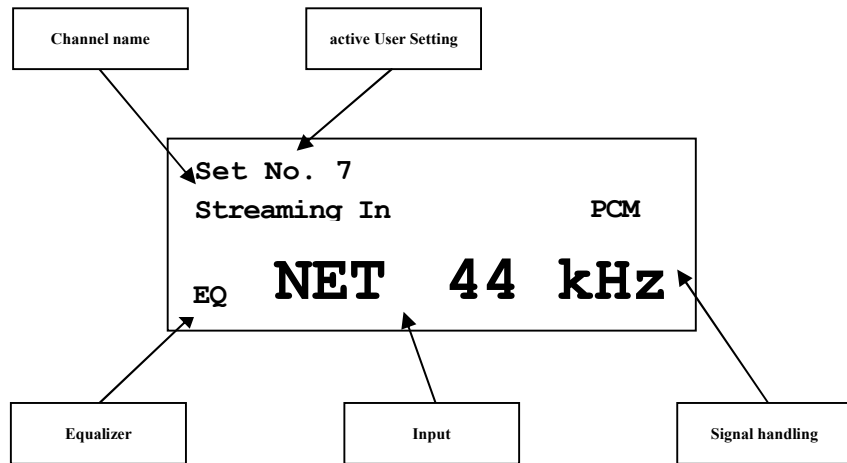

- View 2:

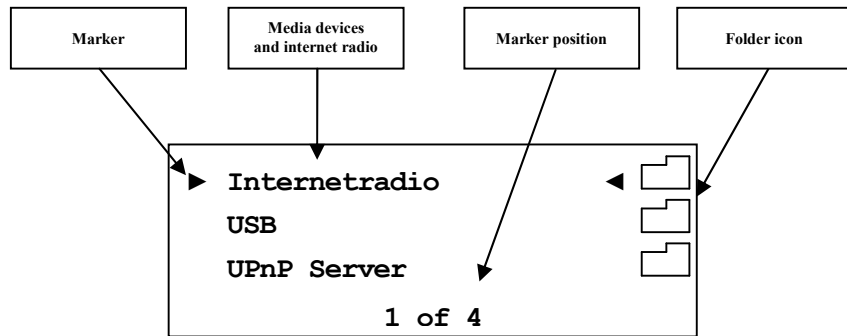

- View 3a (Play from UPnP or USB):

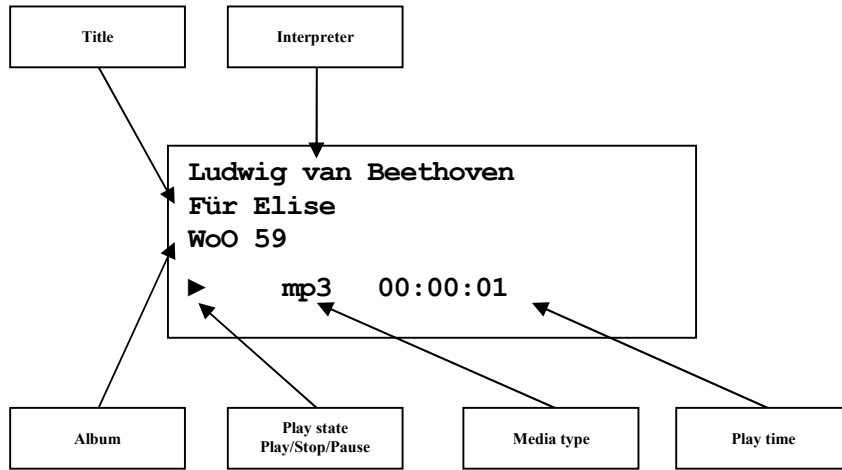

- View 3b (Play from internet radio station):

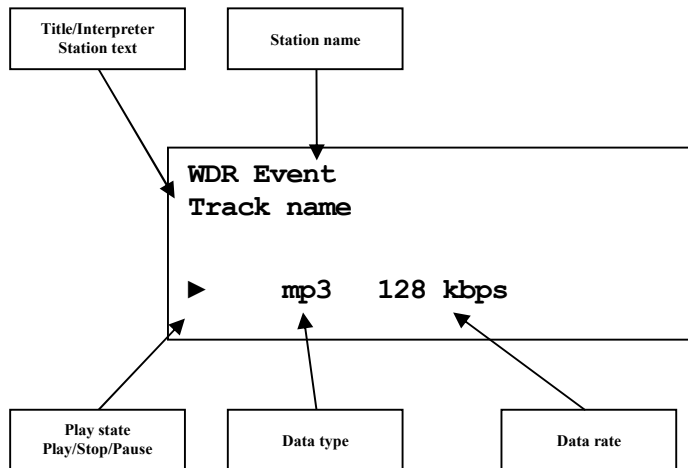

6.2.2 Input selection

Push the **set** key on the front panel once for less than two seconds to enter the input selection menu. Then select the desired input channel with the keys **up** and **down**. In the display, you see the selected input channel, channel number and the user-defined channel name. Press **set** again to actually switch to the selected channel. Overview of DNC input channels:

No.	Inputs	Signal	see 3 - Overview back panel on page 10
1	D1	Digital (electrical)	Digital Inputs IN 1 [15]
2	D2	Digital (electrical)	Digital Inputs IN 2 [15]
3	D3	Digital (AES/EBU)	Digital Inputs IN 3 [14]
4	D4	Digital (optical)	Digital Inputs IN 5 [20]
5	D5	Digital (optical)	Digital Inputs IN 6 [20]
6	NET	Stream, USB, Internet radio	Network [10] [12] [21]
7	USB	USB Audio In	USB Audio [11]
8	FM	FM Tuner	FM Antenna [13]

While switching of inputs, the outputs are switched off at first. Once an input is selected, the outputs are switched on again.



Note

- Leave the input selection function by holding down the **set** key longer than 2 seconds or wait a few seconds.
- Using the Audionet Metal Remote Control *RC 2*, switch to the next or previous input channel without using the **Select Input** function with keys **CH+** and **CH-**.

6.2.3 FM tuner

For setting and saving radio stations to your DNC, please use the software Audionet RCP. You can also setup your radio station frequency manually with the Audionet Metal Remote Control *RC 2* (see section "*7 - Audionet Metal Remote Control RC 2*" on page 28). Use keys **▲** / **▼** to re-load the next / previous FM preset. Press keys **◀** / **▶** to start an automatic scan for the next / previous station.

6.2.4 NET input

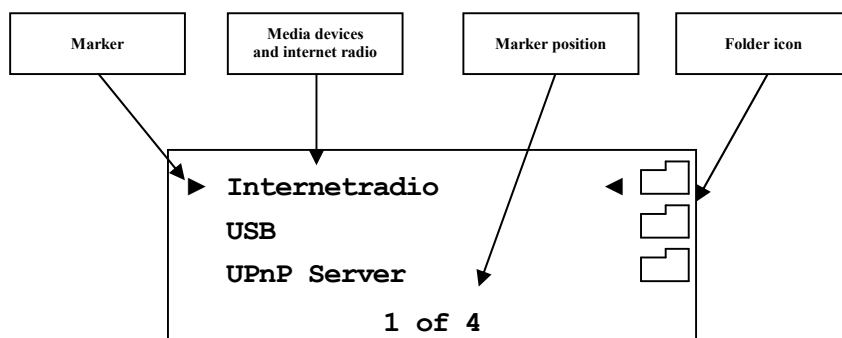

6.2.4.1 Internet radio

With the internet radio service *vTuner* it is possible to select your favourite radio stations from a steadily growing number of worldwide stations. You have to register with an account at *vTuner* to save your favourite stations and to receive personalized recommendations. Beforehand a stable network environment should be set up for your Audionet device (see section "**8.3 - Network setup**" on page 44).

To register an account, open the website <http://audionet.vtuner.com>. You will be going to visit this address every time you wish to edit your favourite radio stations. As long as you do not have registered an account with your Audionet device, you have to click on *Register Here* right below the login. Additionally you will be requested to enter your E-Mail address, to choose a personal passphrase and to enter an access code. There are two possibilities to find your access code. With the Audionet Metal Remote Control *RC 2* select the NET input. Select the first menu item **Internet Radio** using the **OK** key. Navigate to menu entry **Get Access Code**. Confirm with **OK**. You will find your access code consisting of eight digits in line 3 (**3 of 3**). Write down this code and enter it in the registration window within your browser.



Important

- Once you obtained your access code using Audionet Metal Remote Control *RC 2*, write down the given code and put the remote control aside. Proceed with the registration process. Otherwise, every time you will enter menu item **Get Access Code** a different code will be created for the MAC-address of your Audionet device.

The second possibility to receive the access code is to use the software Audionet RCP. With a stable network connection established to your Audionet device, select NET input and open path "Home > Internet Radio > Get Access Code" within the UPnP tab. The code consists of eight digits and can be found in the third line.

As soon as you registered an account for your Audionet device, you are able to log in to the website <http://audionet.vtuner.com> and edit your favourite radio stations. Furthermore, you are able to add radio stations to

your favourites by right-clicking on the station name within software Audionet RCP.

6.2.4.2 USB

Switch the DNC to the NET input channel. Now connect your USB device to the USB(-A) connector [\[12\]](#) and wait until it appears in the display. Supported are devices formatted FAT or FAT32 and that have only one partition. Your USB device appears on top of the list of audio servers/sources in the display. Navigate through the folder structure with the directional keys on your Audionet Metal Remote Control *RC 2* (see section "*7 - Audionet Metal Remote Control RC 2*" on page 28). Enter folders with the **OK** key, get one level back with the **↶** key. Alternatively, use function **Virtual Streaming Client** of RCP (see manual RCP).

6.2.4.3 UPnP server

The easiest way to play music from an UPnP server is to use the software Audionet RCP, the Android app aMM or the iOS app iMM.



Note

- Please have a look into separately available user's manual to our software Audionet RCP. You will find it on our website www.audionet.de.

If you want to use your Audionet Metal Remote Control *RC 2*, navigation through the folders works the same way as described above in section internet radio and USB.

6.2.5 USB Audio

The USB Audio connection [\[11\]](#) allows a direct connection of your DNC to your PC. Play audio files with your favourite software. The DNC serves as sound device / playback device.

For further information see section "*5.3.2 - USB Audio*" on page 15.

7 Audionet Metal Remote Control RC 2

Access every function of the DNC via the included Audionet Metal Remote Control *RC 2*. Additionally, you are able to control power on/off, volume, muting and input channel selection of an Audionet preamplifier. The following sections explain in detail the keys and their corresponding functions.

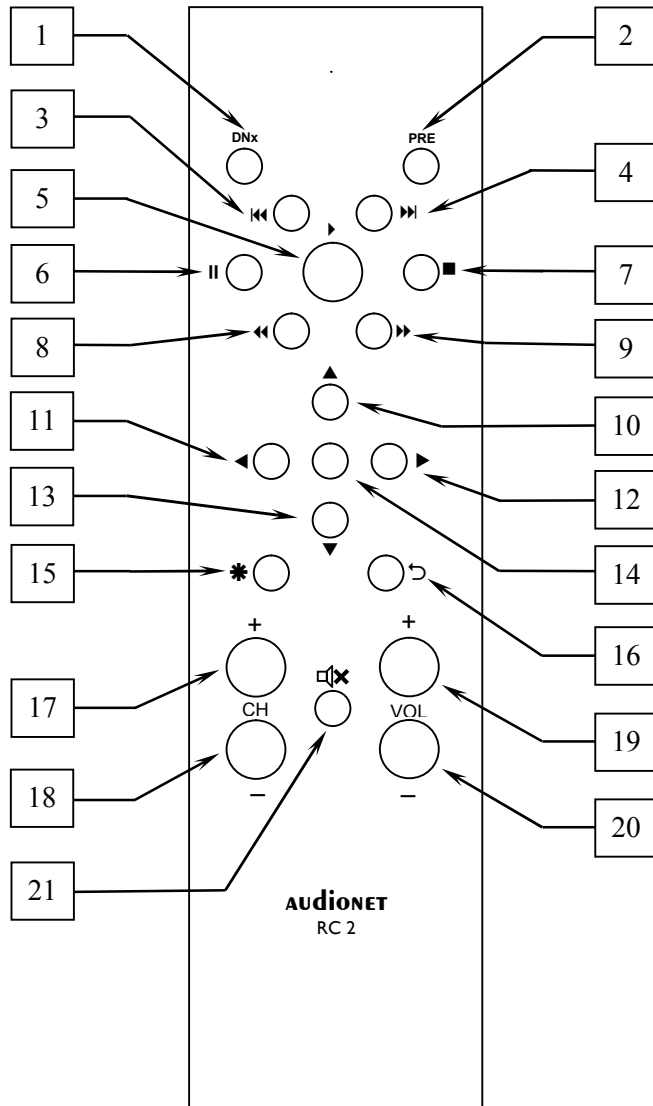

7.1 Key Assignment RC 2

No.	Key	Function
1	DNx	power on / off the DNC
2	PRE	power on / off an Audionet preamplifier
3	⏮	skips back to start of running/previous title
4	⏭	skips to start of next title
5	▶	starts/resumes playback
6	⏸	pauses playback
7	■	stops playback
8	⏮	searches backwards
9	⏭	searches forwards
10	▲	for navigating through menus; moves cursor one step upwards
11	◀	for navigating through menus; moves cursor one step to the left or selects previous option
12	▶	for navigating through menus; moves cursor one step to the right or selects previous option
13	▼	for navigating through menus; moves cursor one step downwards
14	OK	acknowledge selection or enter menus/folders
15	*	enter main menu to setup your system
16	↶	cancel current setup option; get back to parent folder/menu
17	CH +	select next input channel of Audionet preamplifier
18	CH -	select previous input channel of Audionet preamplifier
19	VOL +	increase volume of Audionet preamplifier
20	VOL -	decrease volume of Audionet preamplifier
21	🔇	mute/un-mute Audionet preamplifier

7.2 Changing the batteries

In order to exchange the batteries of your Audionet Metal Remote Control *RC 2*, first you have to remove the six Phillips head screws on the bottom side.

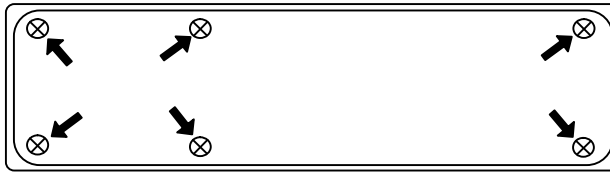

The battery compartment is to the left side of the circuit board. You need two batteries type 'AAA' or 'Micro' with a voltage of 1.5V.

Battery compartment

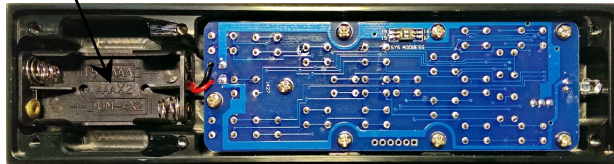

Important

- While inserting the batteries please mind their orientation. The correct orientation is printed onto the bottom of the battery compartment.

7.3 Settings for Audionet DNC



Important

- The Audionet Metal Remote Control *RC 2* is configured to control the DNC by factory default. You do not have to perform any additional configurations. For the sake of completeness, the following section explains the correct setup for the DNC.

Depending on their type, Audionet (pre-) amplifiers use different system addresses for their remote control code. A DIP switch on the circuit board of the Audionet Metal Remote Control *RC 2* selects the desired system address.

In order to set the system address you first have to open up the remote control (see section '*Changing the batteries*' on page 30).

For Audionet Metal Remote Control *RC 2* the DIP switch for selecting the system address is located here:

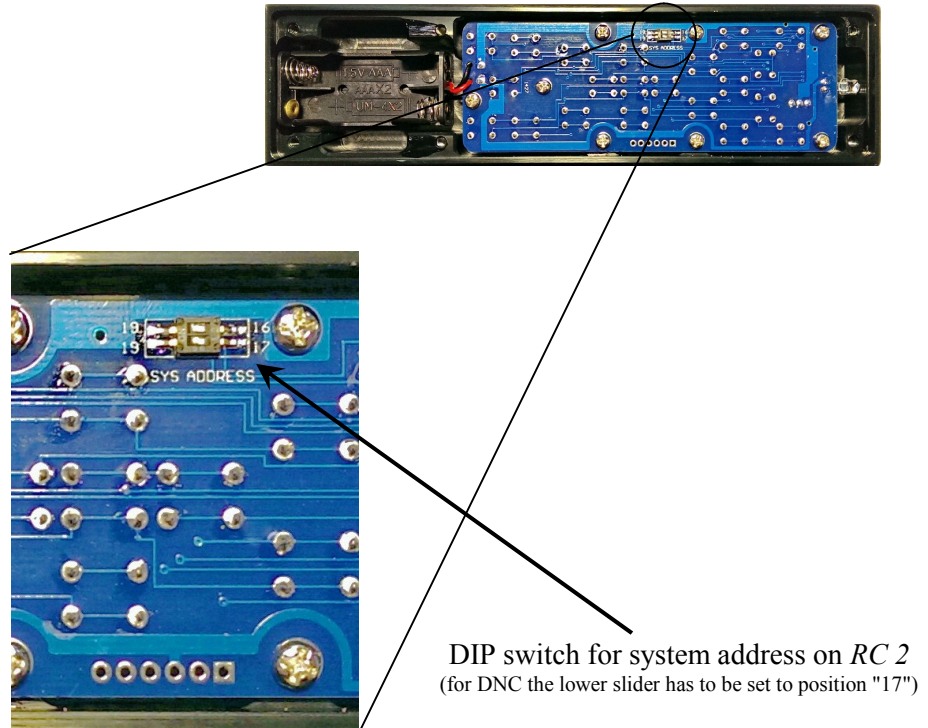

To configure the Audionet Metal Remote Control *RC 2* for controlling the DNC, put the lower slider of the DIP switch labelled 'SYS ADDRESS' in position "17".

To configure the Audionet preamplifier to be controlled by the *RC 2* put the upper slider of the DIP switch in position '19' or '16' according to the following table:

Audionet preamplifier	Address
PRE G2, PRE 1 G3, SAM G2, DNA, DNP, DNA 1	19
MAP 1	16



Note

- If not ordered explicitly, the Audionet Metal Remote Control is pre-configured to setting '19' of the DIP switch for the preamplifier.
- Older models of Audionet preamplifiers use system address 16.



Tip

- If you own an Audionet preamplifier that is not listed in the table above and/or you do not know which system address it uses, then simply try out both settings.

8 Device setup

To adjust the DNC to your preferences, please use the setup menu. Navigate in the menu with the keys on the front panel of your DNC or with your remote control. For a more comfortable adjustment, use our software Audionet RCP. You just need to integrate your DNC to your network (see section "*8.3.10 - Example for Network setup*" on page 57).

To control your DNC with front panel keys, use **set**, **up** and **down**.

- set** push and hold the key for longer than 2 seconds to open the system menu. To cancel and leave the menu without saving, hold down the key for longer than 2 seconds again. A short keystroke saves / applies settings or opens menus / folder.
- up, down** are used to change parameters or select menu items.

For easier control, use the directional keys on your Audionet Metal Remote Control *RC 2* (see section "*7 - Audionet Metal Remote Control RC 2*" on page 28).

The most comfortable way to setup your DNC is to use our software Audionet RCP. Use mouse and keyboard to adjust each parameter. The computer display provides all information at a glance (see also Audionet RCP user's manual).



Note

- Changes will only take effect if you push the **OK** key on your remote or push the **set** key shortly on the DNC front panel.
- Within menus with more than one page, the quickest way to reach the last items is to press **up**. E.g. to get item **9 of 9**, open the main menu (marker is at **1 of 9**) and press **up** once instead of striking **down** several times. Use the same procedure with keys **▲ / ▼** on the Audionet Metal Remote Control *RC 2*.

8.1 Overview device menu

Select Input	
Global Setup	Function
Display	Setup display brightness
Auto start	Setup auto start mode
Power-Off Mode	Setup stand-by mode
Serial Port	Setup serial port
Channel Name	Edit name of input channel (12 characters)
Digital EQ	Switch on /off digital Equalizer
Digital EQ Setup	Setup the parametric 5-band-equalizers (separately for each channel)
Trigger Out	Setup Trigger Out for control of non Audionet devices (e.g. active subwoofer)
Speaker Distance	Setup distance between speakers and listening position
Network Setup	
Manage Network	Manage main network setup
Connection Type	Select type of connection
DHCP	Switch on/off DHCP
IP Address	Setup IP address for your DNC
IP Mask	Setup subnet mask
Gateway	Setup gateway IP address
DNS	Setup DNS IP address
RCP Port	Setup network port for software Audionet RCP
Wireless Setup	Setup Wi-Fi (SSID, security, etc.)
Factory Default Reset	
Reset All Settings	Reset all settings (except Network Module)
Reset EQ Settings	Reset all EQ settings only
Reset User Settings	Reset all User Settings only
Reset Network Module	Reset Network Module
Reset FM Stations	Reset all FM station presets
Save User Setting	
Load User Setting	
Device Info	

8.2 Global setup

8.2.1 Select Input

Push the **set** key on the front panel once for less than two seconds or push the key ***** on the Audionet Metal Remote Control *RC 2* to enter the **Select Input** menu item. Then select the desired input channel with the keys **up** and **down** or with the keys **◀ / ▶** on the remote control. In the display, you see the selected input channel, channel number and your chosen channel name. Press **set** or **OK** to actually switch to the selected channel.

Overview of DNC input channels:

No.	Inputs	Signal	<i>see 3 - Overview back panel on page 10</i>
1	D1	Digital (electrical)	Digital Inputs IN 1 [15]
2	D2	Digital (electrical)	Digital Inputs IN 2 [15]
3	D3	Digital (AES/EBU)	Digital Inputs IN 3 [14]
4	D4	Digital (optical)	Digital Inputs IN 5 [20]
5	D5	Digital (optical)	Digital Inputs IN 6 [20]
6	NET	Stream, USB, Internet radio	Network [10] [12] [21]
7	USB	USB Audio In	USB Audio [11]
8	FM	FM Tuner	FM Antenna [13]

While switching of inputs, the outputs are switched off at first. Once an input is selected, the outputs are switched on again.



Note

- Leave the input selection function by holding down the **set** key longer than 2 seconds or wait just a few seconds.
- Using the Audionet Metal Remote Control *RC 2*, switch to the next or previous input channel without using the **Select Input** function with keys **CH+** and **CH-**.

8.2.2 Display

Adjust the display brightness with the front panel keys or your Audionet Metal Remote Control *RC 2*.

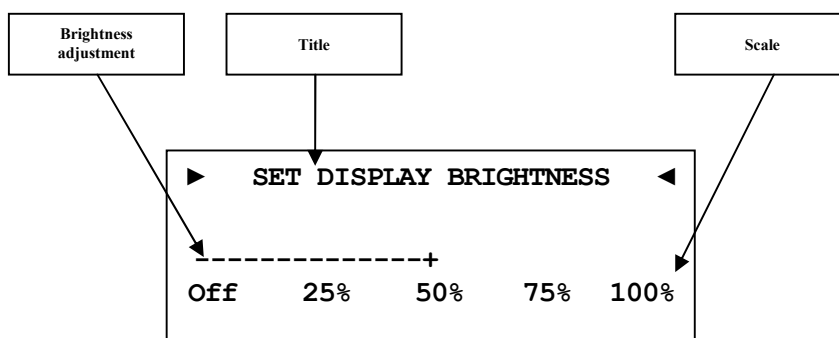

Note

- Get to this option anytime opening the **Global Setup** and navigating to **Display**. Use directional keys ◀ / ▶ on the Audionet Metal Remote Control *RC 2* or **up / down** on the front panel to select desired brightness.
- It is also possible to set display brightness with the software Audionet RCP.
- Is the brightness set to **Off** the display is only on during setup. It switches off automatically several seconds after the last user input.
- The DNC activates the display saver automatically 12 minutes after last user input/activity.
- During active display saver, the display shows only the number of the selected input channel (e.g. **D1 - Digital In 1**). The display brightness is always reduced to 25%, and the location of the information text will change randomly every 12 seconds to prevent any burn-in effect of the display.
- The display saver is deactivated, and the display returns to its normal mode as soon as any user input is detected
- The user cannot switch off the automatic display saver function!



Important

- **Long-term usage of the display set to maximum brightness (setting 100%) may cause extended signs of wear resulting in a decay of contrast or brightness of individual dots in the display. Do not use the display with a brightness set higher than the factory default of 50% for a longer period of time!**



Tip

- For a more comfortable access, use the directional keys ◀ / ▶ on the Audionet Metal Remote Control *RC 2* (see section "*7 - Audionet Metal Remote Control RC 2*" on page 28). Acknowledge your selection with the **OK** key.

8.2.3 Auto start

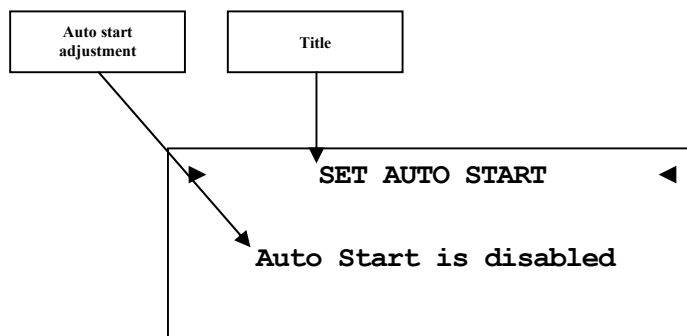

disabled The Auto Start function is disabled. After switching on the mains switch **1** on the back panel, the DNC enters the stand-by mode. You have to use the **power** key on the front panel or the key **DNx** on the Audionet Metal Remote Control *RC 2* to switch on the unit into normal operating mode.

active The Auto Start function is active. As soon as you connect the DNC to mains (i.e. use the mains switch **1** on the back panel) the unit starts up automatically to normal operating mode. Use this setting for timer controlled operations.



Tip

- For a more comfortable access, use the directional keys ◀ / ▶ on the Audionet Metal Remote Control *RC 2* (see section "*7 - Audionet Metal Remote Control RC 2*" on page 28). Acknowledge your selection with the **OK** key.

8.2.4 Power-off mode

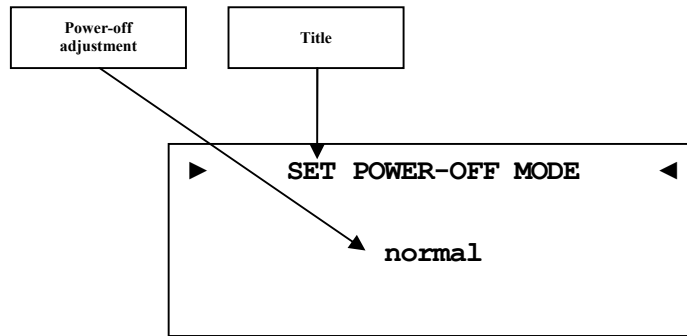

There are two different power-off modes available for the DNC. Firstly the **normal** power-off mode and secondly the **Quick Start** mode.

The factory default setup is the **normal** mode, because of low power consumption in stand-by (less than 1W). If you use normal power mode, you cannot switch on with the software Audionet RCP.

With the **Quick Start** mode selected, the network interface remains active, and the DNC start up process is accelerated, because the network interface does not need to boot up first. Furthermore, you can use software Audionet RCP to power on. If you select **Quick Start** mode the power consumption is increased. For further details please see section *"9.7 - Specifications" on page 73*.



Tip

- For a more comfortable access, use the directional keys ◀ / ▶ on the Audionet Metal Remote Control *RC 2* (see section *"7 - Audionet Metal Remote Control RC 2" on page 28*). Acknowledge your selection with the **OK** key.

8.2.5 Serial Port

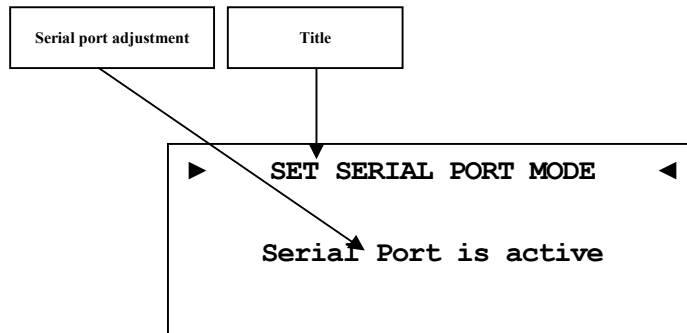

disabled The serial port is disabled. In this state you are not able to control the DNC via the serial port (e.g. by a home automation system). Select this setting, if you do not want to control the DNC via the serial port.

active The serial port is active. Control your DNC via the serial port (e.g. by a home automation system).



Important

- If you like to use the serial port **RS232** 6 for controlling the DNC, you **have** to enable the serial port (**active**).
- While the serial port is configured active, the power consumption of the DNC in stand-by mode will be higher even if the power-off mode **normal** is selected.
- Disable the serial port if you do not wish to control the DNC via this interface (e.g. by a home automation system).



Tip

- For a more comfortable access, use the directional keys ◀ / ▶ on the Audionet Metal Remote Control *RC 2* (see section "*7 - Audionet Metal Remote Control RC 2*" on page 28). Acknowledge your selection with the **OK** key.

8.2.6 Channel name

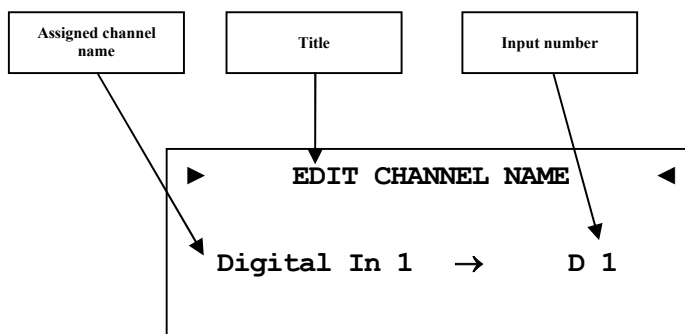

You can assign a fully user-definable name up to 12 characters in length to each of the eight input channels. The display shows the number of the currently selected input channel and the assigned channel name. The cursor marks the character you now may alter.

Use keys **up** / **down** on the front panel or keys **▲** / **▼** of the Audionet Metal Remote Control *RC 2* to alter the character marked by the cursor. Press and hold **set** for longer than 2 seconds or press key **▶** to move the cursor one position to the right. Key **◀** moves the cursor one position to the left. To finish editing the channel name press **set** or **OK**.



Note

- For easier editing of the channel name use the software Audionet RCP (see user's manual RCP).
- All settings apply to the currently selected input channel.

8.2.7 Digital Equalizer

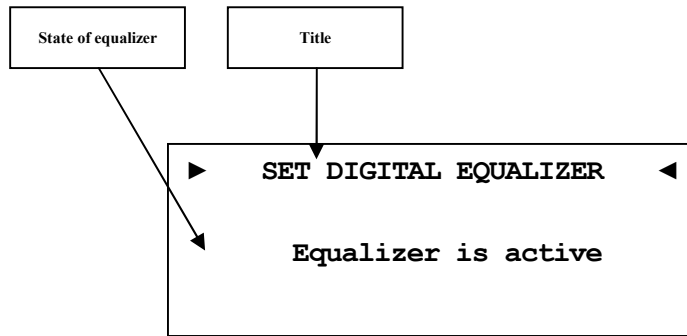

disabled The digital equalizer is disabled.

active The digital equalizer is active and all the settings from menu item **Digital EQ Setup** are applied to the currently selected input channel.



Tip

- For a more comfortable access, use the directional keys ◀ / ▶ on the Audionet Metal Remote Control RC 2 (see section "7 - Audionet Metal Remote Control RC 2" on page 28). Acknowledge your selection with the **OK** key.

8.2.8 Digital equalizer setup

The digital EQ is a parametric 5-band equalizer with separated adjustment for left and right channel.

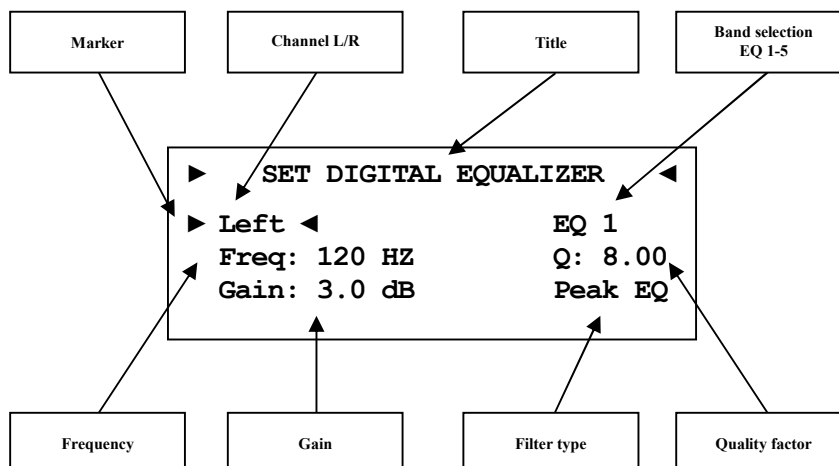

Navigate through the menu of the digital EQ with the directional keys ◀/▶/▲/▼ on your Audionet Metal Remote control RC 2. Keys ▲/▼ select the parameter you like to adjust. Keys ▶/◀ change the selected parameter. If you enter the digital equalizer menu item, the first selected parameter is the speaker channel. Here you select the speaker channel you want to adjust: [**Left**, **Right**].

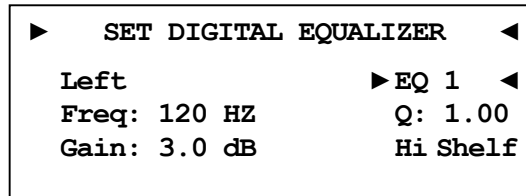

The next parameter to adjust is the EQ band [**EQ 1 – EQ 5**]. For each band you can adjust the following parameter:

Freq center- respectively cutoff-frequency (depends on filter)

Q filter quality (depends on filter)

Gain gain (from -12 dB to +6 dB)

Filter type choose between seven different filter types

Filter type	Short description
Peak EQ	Band-pass filter
Hi Shelf	Treble control
Lo Shelf	Bass control
LP 2nd	Low-pass filter 2 nd order
HP 2nd	High-pass filter 2 nd order
LP 1st	Low-pass filter 1 st order
HP 1st	High-pass filter 1 st order



Note

- For easier adjustment of equalizer parameters use the software Audionet RCP (see user's manual RCP).
- All settings apply to the currently selected input channel.

8.2.9 Trigger out

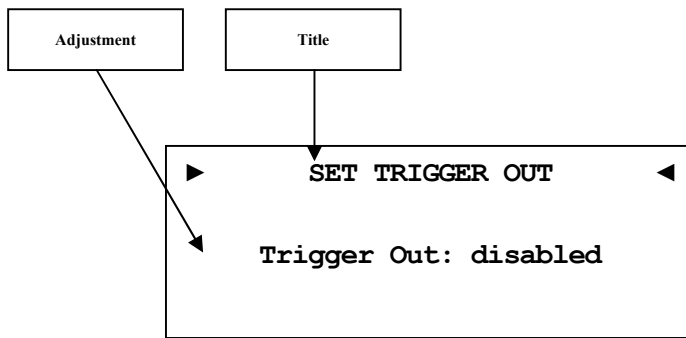

Use trigger output **TRIGGER** 7 to control (e.g. switch on/off) non Audionet devices. If you switch on the DNC from stand-by mode, the trigger output 7 provides a signal of 12 Volts DC.

The voltage of the trigger output can be re-configured to 5 Volts DC. Changing the voltage must be done by authorized personnel only. Please ask your local dealer for support.



Note

- All settings apply to the currently selected input channel.



Tip

- For a more comfortable access, use the directional keys ◀ / ▶ on the Audionet Metal Remote Control *RC 2* (see section "*7 - Audionet Metal Remote Control RC 2*" on page 28). Acknowledge your selection with the **OK** key.

8.2.10 Speaker distance

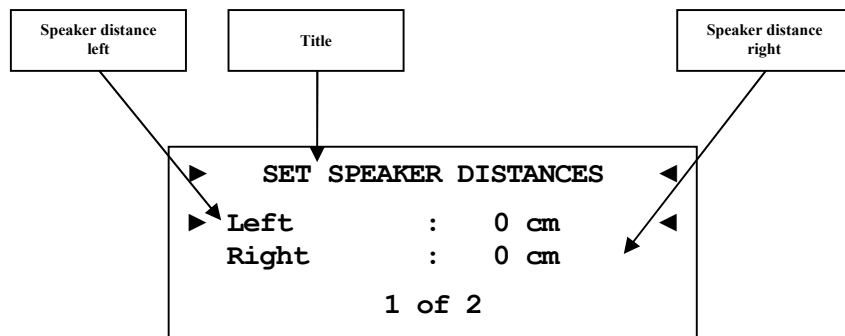

Use this menu to enter the distances from your speakers to your listening position. The distance ranges from 0 to 700 cm in steps of 5 cm. According to the entered distances, the DNC calculates the necessary delays of each channel to ensure that all signals from all speakers arrive at the same time at the listening position.



Tip

- For a more comfortable access, use the directional keys ◀ / ▶ and ▲ / ▼ on the Audionet Metal Remote Control RC 2 (see section "7 - Audionet Metal Remote Control RC 2" on page 28). Acknowledge your selection with the OK key.

8.3 Network setup

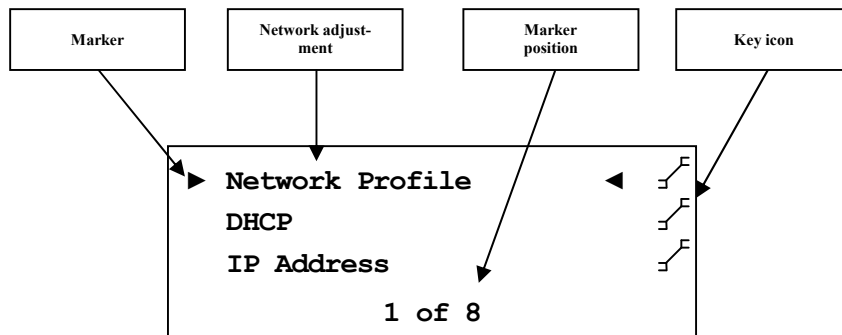

Your DNC is set to receive DHCP* information from your network. If you connect your device to a wired network, it should be ready to use. For use of fixed IP address, you may contact your network administrator to get the information you need to setup the DNC correctly for your network.

Use keys **up** / **down** on the front panel or keys **▲** / **▼** of the Audionet Metal Remote Control *RC 2* to alter the character marked by the cursor. Press and hold **set** for longer than 2 seconds or press key **▶** to move the cursor one position to the right. Key **◀** moves the cursor one position to the left. To erase the character marked by the cursor use key **↶**. To finish editing, press **set** or **OK**.



Note

- You will find a step-by-step example for network configuration at the end of the section (see section: *"8.3.10 - Example for Network setup" on page 57*).
- Most network related terms are defined in glossary (see section: *"9.1 - Glossary" on page 65*).

*see section: *"9.1 - Glossary" on page 76*

8.3.1 Manage Network

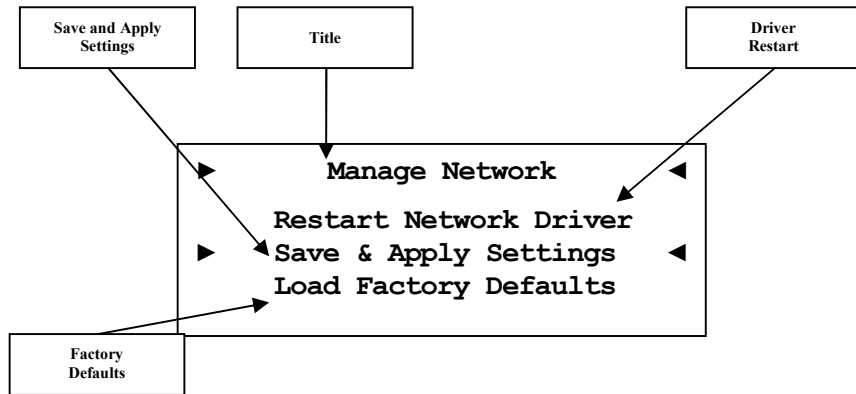

In this menu you will find the basic setup for managing the network preferences of your DNC. The following explains the menu in detail.

Use keys **up** / **down** on the front panel or keys **▲** / **▼** of the Audionet Metal Remote Control *RC 2* to select desired menu option. To acknowledge selected option, press **set** or **OK**.

8.3.1.1 Restart Network Driver

Sometimes it might be necessary to restart the network driver of the DNC. With this function, you are able to restart the driver without having to switch off the device completely. The driver restarts with its current settings.

Select this menu item and confirm your selection with **set** or **OK**. The DNC issues the following message:

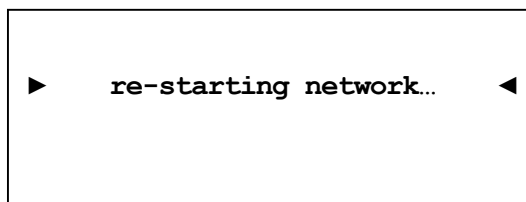

It takes about 30 seconds for the driver to restart. Then your Audionet device will be available in the network again.

8.3.1.2 Save & Apply Settings

You have to select this option every time you finished the network configuration and want to save and apply the new values. Any changes made to your network setup will be dismissed without saving and applying unless you select this particular option.

Select this menu option and confirm your selection with **set** or **OK**. It takes about 30 seconds for the driver to restart. Then your Audionet device will be available in the network again.



Note

- You have to execute this menu option if you want to save and apply your latest changes to the network settings. Otherwise, your configuration will be dismissed!

8.3.1.3 Load Factory Defaults

This function allows you to restore the factory settings of your DNC's network driver. The DNC is factory-set to wired Ethernet connection with DHCP activated. This way, if you connect your device to a wired network, it should be ready to use.

Select this menu option and confirm your selection **set** or **OK**. The DNC loads now the factory default settings.

After successfully loading the factory defaults, the cursor automatically marks the menu item **Save & Apply Settings**. You must execute this menu item as described in section "*8.3.1.2 - Save & Apply Settings*" on *page 46* to apply the factory defaults.



Note

- You have to execute menu item **Save and Apply Settings** if you want to save and apply the factory default settings. Otherwise, this configuration will be dismissed!
- If you accidentally selected this option and the factory default settings are loaded, you are able to exit the menu with the key ***** of your Audionet Metal Remote Control *RC 2* or by holding down the **set** key for longer than 2 seconds. This way the settings accidentally loaded will not be activated and your previous settings will remain.

8.3.2 Connection Type

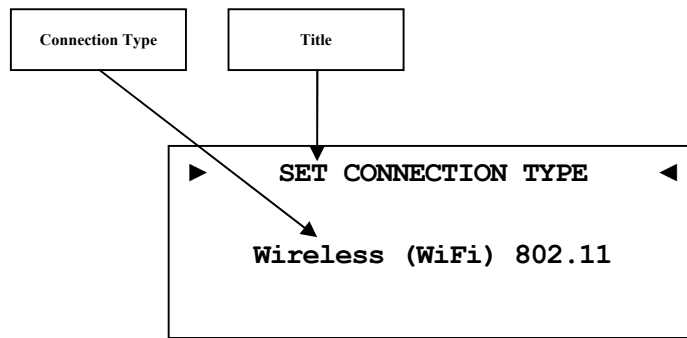

Wired Ethernet Factory setting. Your DNC uses a wired network connection (Ethernet connection).

Wireless (WiFi) Your DNC establishes a wireless connection via the included WLAN Antenna.

The menu *"Wireless setup" on page 51* and its submenus are only available if you select **Wireless (WiFi) 802.11**.

8.3.3 DHCP

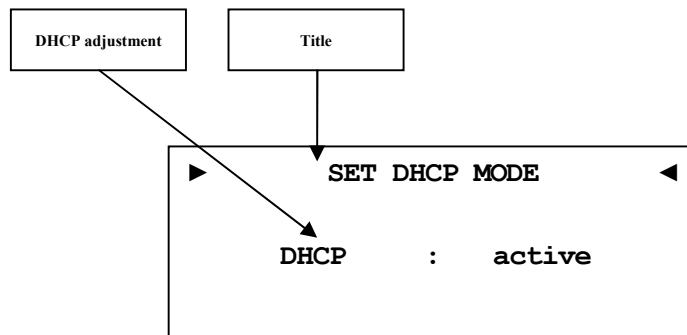

disabled DHCP client mode is disabled

active Your DNC will try to get information via DHCP.

You do not need to setup the following menu items if the IP address is received from a DHCP server. Menu item IP address, IP mask, gateway and DNS are without effect, and they are overwritten by DHCP information.



Note

- If DHCP is active the following menu items **IP Address**, **IP Mask**, **Gateway** and **DNS** are not available as this information are provided by the DCHP server in your network.



Tip

- For a more comfortable access, use the directional keys ◀ / ▶ on the Audionet Metal Remote Control *RC 2* (see section "*7 - Audionet Metal Remote Control RC 2*" on page 28). Acknowledge your selection with the **OK** key.

8.3.4 IP Address

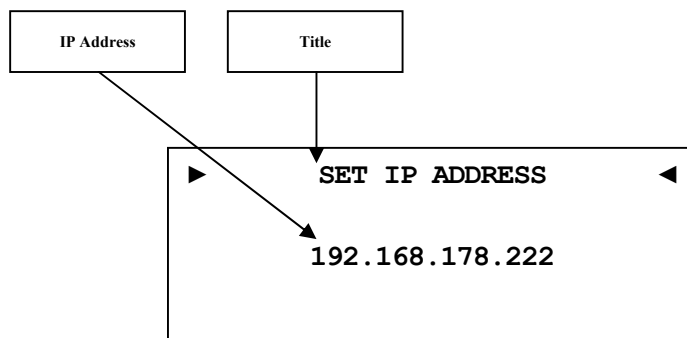

Enter the fixed IP address you would like to assign to the DNC.

The IP address type is IPv4 (e.g. 192.168.178.222).



Tip

- Use the directional keys on your Audionet Metal Remote Control *RC 2*. Confirm everything with **OK** key.



Note

- Each block of an IP address consists of three digits. Sometimes the triplets are not written down in full length, i.e. the leading zeros are omitted. For a valid IP addresses you have to always enter all 3 digits. If necessary, amend the leading zeros. Example: 0.1.10.100 has to be entered as 000.001.010.100.

8.3.5 IP Mask

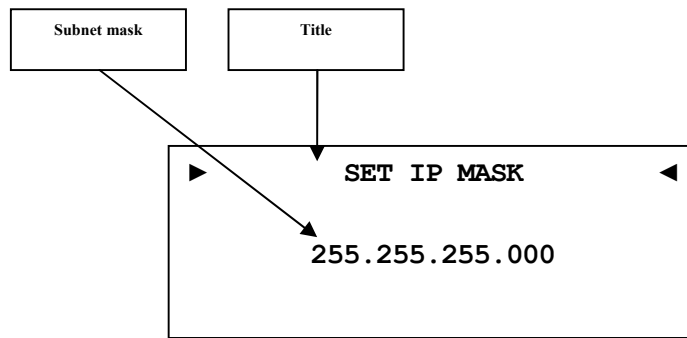

Enter the desired subnet mask (e.g. 255.255.255.000).



Tip

- Use the directional keys on your Audionet Metal Remote Control RC 2. Confirm everything with **OK** key.



Note

- Each block of an IP address consists of three digits. Sometimes the triplets are not written down in full length, i.e. the leading zeros are omitted. For a valid IP addresses you have to always enter all 3 digits. If necessary, amend the leading zeros. Example: 0.1.10.100 has to be entered as 000.001.010.100.

8.3.6 Gateway

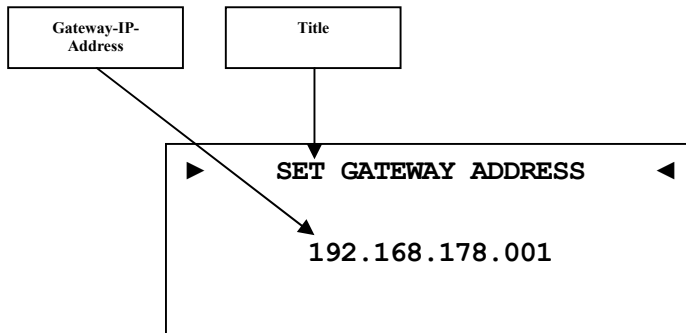

Enter the IP address of the gateway in your network (e.g. 192.168.178.001).



Tip

- Use the directional keys on your Audionet Metal Remote Control RC 2. Confirm everything with **OK** key.
- The gateway address is usually the same as the router IP address.



Note

- Each block of an IP address consists of three digits. Sometimes the triplets are not written down in full length, i.e. the leading zeros are omitted. For a valid IP addresses you have to always enter all 3 digits. If necessary, amend the leading zeros. Example: 0.1.10.100 has to be entered as 000.001.010.100.

8.3.7 DNS

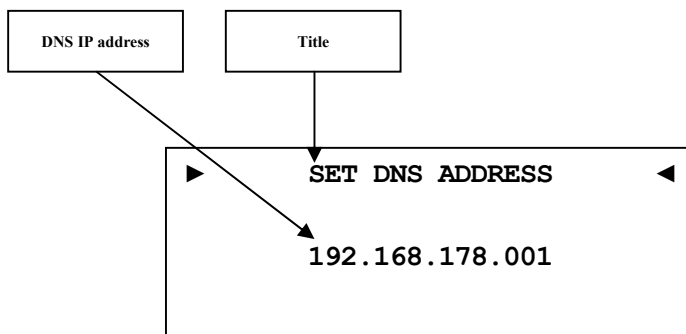

Setup your DNS IP address (e.g. 192.168.178.001).



Tip

- Use the directional keys on your Audionet Metal Remote Control *RC 2*. Confirm everything with **OK** key.
- The DNS IP address is usually the same as the router IP address.



Note

- Each block of an IP address consists of three digits. Sometimes the triplets are not written down in full length, i.e. the leading zeros are omitted. For a valid IP addresses you have to always enter all 3 digits. If necessary, amend the leading zeros. Example: 0.1.10.100 has to be entered as 000.001.010.100.

8.3.8 RCP port

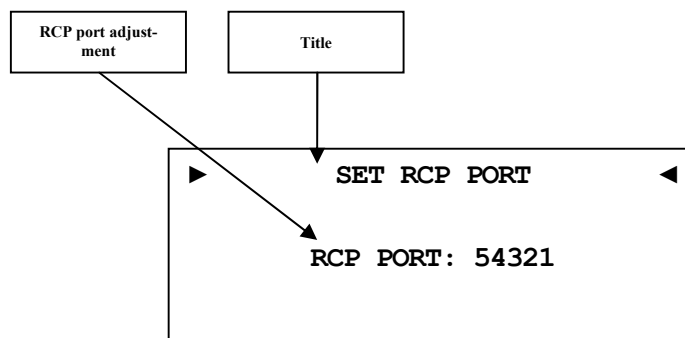

Enter the port number for communication between DNC and the software Audionet RCP or Android app aMM or iOS app iMM. If necessary, you may adjust the port number in a range of 50000 to 59999. The factory default value is 54321. Changing the default value will only be necessary if this port number is already used in your network. If necessary, ask your network administrator for support.



Tip

- Use directional keys ◀/▶ on your Audionet Metal Remote Control *RC 2* to adjust port number. Confirm with **OK** key.

8.3.9 Wireless setup

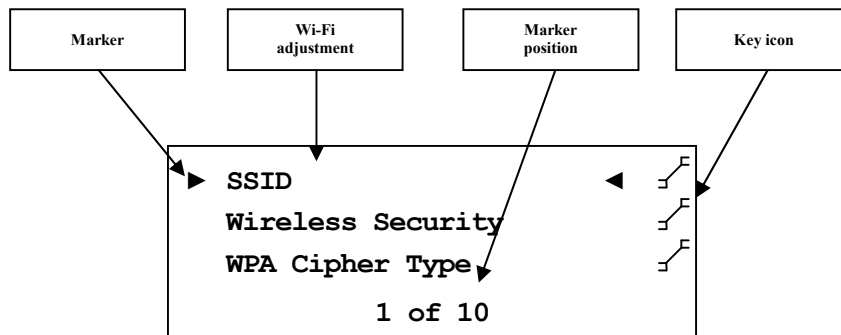

All Wi-Fi settings have to be entered manually.

Gather the necessary information to setup the Wi-Fi connection from the settings of your router or access point. If you have no access to this information, please ask your network administrator.

Depending on the security type for your Wi-Fi connection the menu options might differ. If you select WPA or WPA2 security, please continue with section 8.3.9.3 for further setup. If you selected the old and less secure method WEP, then you have to adjust the settings in sections 8.3.9.4 to 8.3.9.6.



Tip

- Alternatively, you may use the software Audionet RCP for the Wireless setup. For the time of configuration, you need to connect your DNC to the network by wire. Later you may disconnect the cable for using a Wi-Fi connection.



Important

- For security reasons we strongly recommend you select the up-to-date WPA2 encryption method for your Wi-Fi connection!

8.3.9.1 SSID

Enter the name of your Wi-Fi connection. Please mind the case sensitive input.

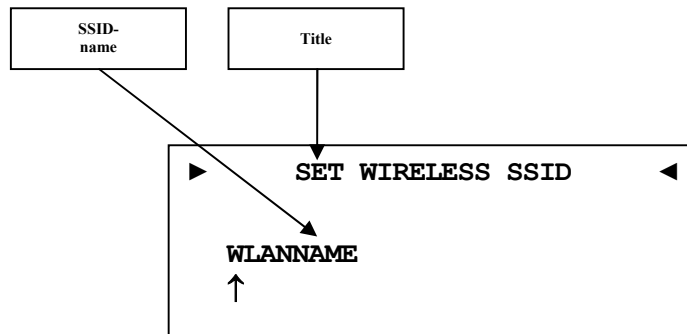

Note

- Use keys **up** / **down** on the front panel or keys **▲** / **▼** of the Audionet Metal Remote Control *RC 2* to alter the character marked by the cursor. Press and hold **set** for longer than 2 seconds or press key **▶** to move the cursor one position to the right. Key **◀** moves the cursor one position to the left. To finish editing, press **set** or **OK**.
- To erase the character marked by the cursor use key **↶**. In this case the key **↶** does not return to the parent menu. To exit the SSID name setup without saving changes please press key *****.

8.3.9.2 Wireless security

Select your Wi-Fi security method. Please see the configuration of your router or access point which setting you need. The security method of DNC and router / access point has to be the same.

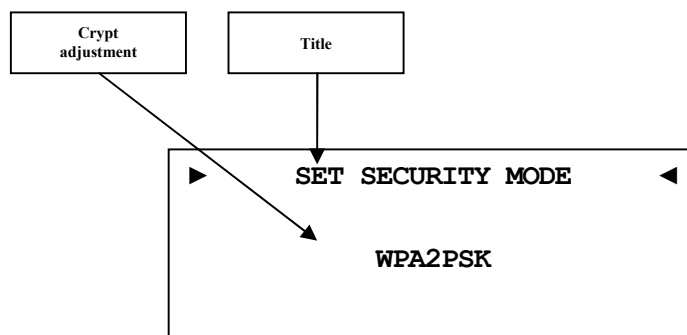

None	no security method selected (not recommended).
WEP	Wired Equivalent Privacy, out-dated and unsecure security standard (not recommended).

WPAPSK Wi-Fi Protected Access Pre-shared Key was a transitional standard to replace WEP until the new WPA2 was defined (not recommended).

WPA2PSK Wi-Fi Protected Access 2 Pre-shared Key is the regular standard for Wi-Fi security (recommended).



Note

- Use directional pad left/right on your Audionet Metal Remote Control *RC 2*. Confirm everything with **OK** key.
- You will find Wikipedia links to all security method related terms in section *"9.2.1 - Wireless security" on page 67*.



Tip

- Use directional keys ◀/▶ on your Audionet Metal Remote Control *RC 2* to adjust port number. Confirm with **OK** key.
- In the preferences of some new routers / access points security method WPA2PSK is referred to as "WPA2PSK – Personal" or "WPA2 – Personal".

8.3.9.3 WPA pass phrase

Enter your WPA passphrase. Please note that passphrase is case sensitive. This menu item is only available if you selected **WPAPSK** or **WPA2PSK** for the security method.

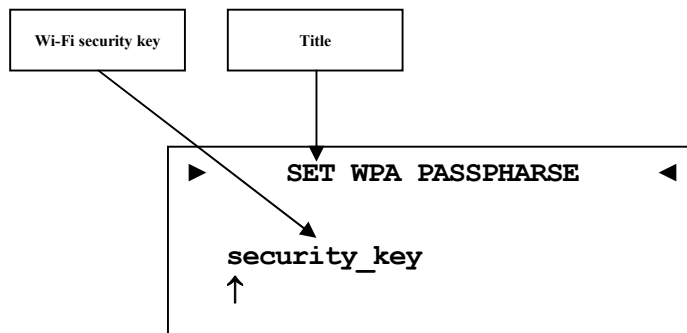

Note

- Use keys **up** / **down** on the front panel or keys ▲ / ▼ of the Audionet Metal Remote Control *RC 2* to alter the character marked by the cursor. Press and hold **set** for longer than 2 seconds or press key ▶ to move the cursor one position to the right. Key ◀ moves the cursor one position to the left. To finish editing, press **set** or **OK**.
- To erase the character marked by the cursor use key ↵. In this case the key ↵ does not return to the parent menu. To exit without saving changes please press key *.

- The passphrase has to consist of at least 8 characters. Maximum length is 63 characters. The longer the passphrase the more secure the connection. For further information, see the documentation of your router / access point.

8.3.9.4 WEP authentication

Select the WEP setup to your network.

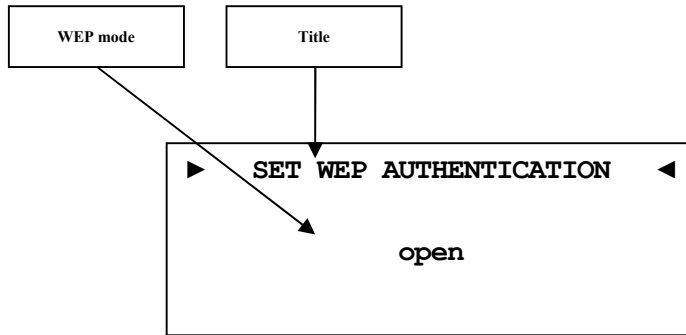

- open** Open Authentication
- shared** Shared-Key-Authentication



Note

- Chose the authentication mode with the directional keys. ◀ for **open** and ▶ for **shared**. Confirm the adjustment with the **OK** key.
- We strongly recommend using WPA2PSK standard to secure your Wi-Fi connection. WEP is not secure.

8.3.9.5 WEP key index

Select the Index Key 0-3

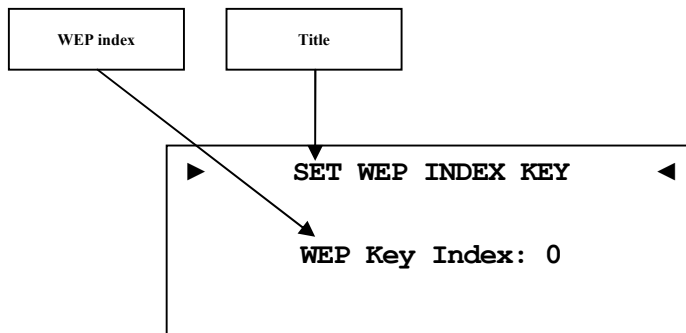



Note

- Select the WEP key index with your directional keys ◀ / ▶. Confirm the adjustment with the **OK** key.

8.3.9.6 WEP key 0-3

Enter the WEP key phrase for key 0 - 3.

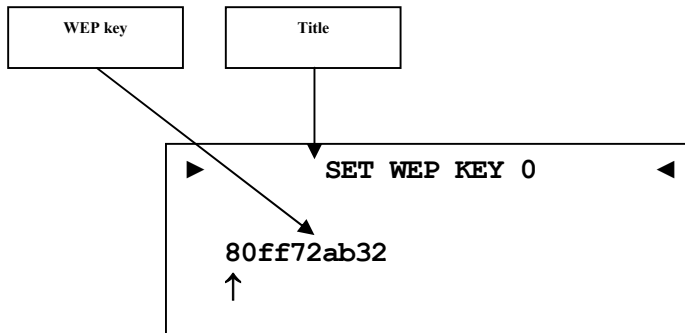

Note

- Use keys **up** / **down** on the front panel or keys ▲ / ▼ of the Audionet Metal Remote Control *RC 2* to alter the character marked by the cursor. Press and hold **set** for longer than 2 seconds or press key ▶ to move the cursor one position to the right. Key ◀ moves the cursor one position to the left. To finish editing, press **set** or **OK**.
- To erase the character marked by the cursor use key ↶. In this case the key ↶ does not return to the parent menu. To exit without saving changes please press key *.
- A WEP key contains only numbers 0-9 and letters a-f.
- Length of WEP keys:
64 bit hex WEP key: 10 characters
128 bit hex WEP key: 26 characters.

8.3.10 Example for Network setup

In this example, we will use the Audionet Metal Remote Control to make all adjustments (see section "7 - Audionet Metal Remote Control RC 2" on page 28). Open the system menu with key ***** and mark the menu item **Network Setup** with the directional keys **▲** / **▼**. Confirm with **OK** key.

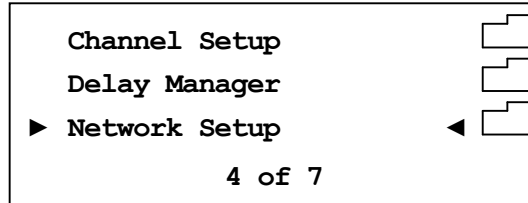

Switch to menu item **Connection Type**.

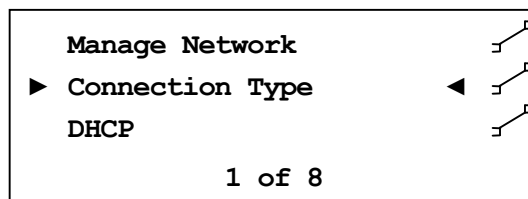

Choose your preferred connection type with the keys **◀** / **▶**. Connection types **Wired Ethernet** and **Wireless (WiFi) 802.11** are available. Confirm with **OK**.

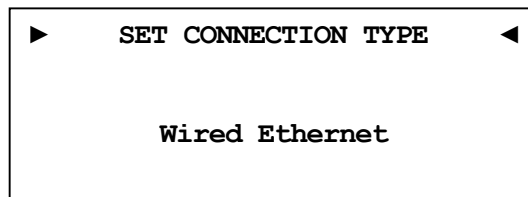

In this example, we assume that you do not use DHCP in your network. Therefore, we disable the DHCP function and set a fixed IP address. Open the menu item **DHCP**, press the key **◀** to select **disabled** and confirm with **OK** key. The DNC recognizes the new setting and switches back to the Network Setup menu.

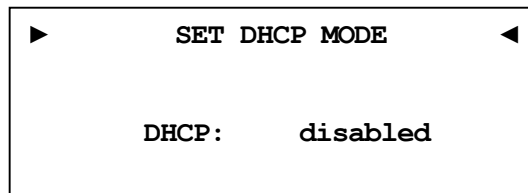

Now you have to enter the IP address you selected for your DNC. (e.g. 192.168.178.222 or 192.168.000.222 or 192.168.001.222).

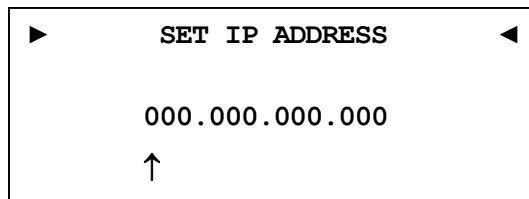

```
▶          SET IP ADDRESS          ◀  
  
000.000.000.000  
  ↑
```

Enter the IP address using the keys ▲ / ▼ of the Audionet Metal Remote Control *RC 2* to alter the character marked by the cursor. Press key ▶ to move the cursor one position to the right. Key ◀ moves the cursor one position to the left. To finish editing, press **set** or **OK**.

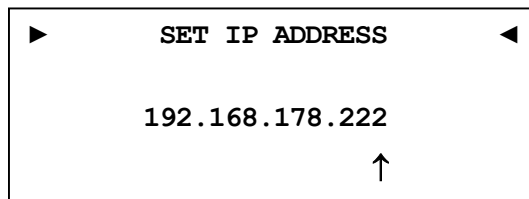

```
▶          SET IP ADDRESS          ◀  
  
192.168.178.222  
                ↑
```

Select the menu item **IP Mask** and compare the default settings with the data of your network. The default value 255.255.255.000 is probably suitable for most of the home networks. Confirm with **OK**. Otherwise, enter your settings as described above with IP address.

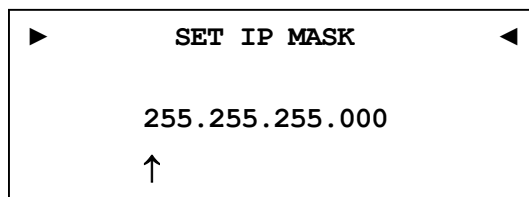

```
▶          SET IP MASK          ◀  
  
255.255.255.000  
  ↑
```

The gateway in your network is probably the router, so you have to set the router's IP address as the gateway address. Enter the correct address for your network and confirm.

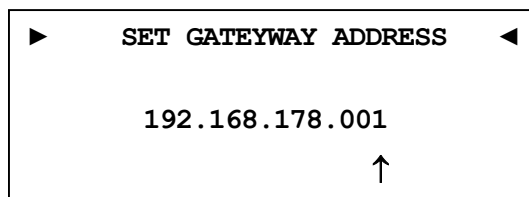

```
▶          SET GATEWAY ADDRESS    ◀  
  
192.168.178.001  
                ↑
```

Most of the times, the DNS address is the same like the router's IP address. If you use a different DNS, enter the DNS IP address which is correct for your network configuration.

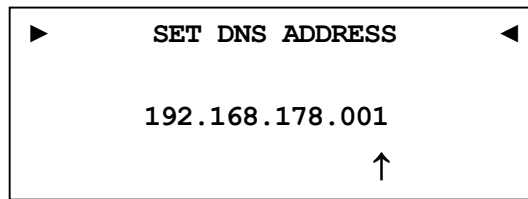

The setup for using a fixed IP address is now completed.

If you use your DNC in a wired network, the network setup is completed. You can now save and apply your network settings. In case you would like to use a Wi-Fi connection skip to paragraph "Wi-Fi adjustment".

Save network profile

Go to menu item **Manage Network** and select **Save & Apply Settings**. Confirm with **OK**. The new created network profile with all its settings is now saved and will immediately be applied.

Wi-Fi adjustment

Go to menu **Manage Network** and select **Connection Type**. Now change the setting to **Wireless (WiFi) 802.11** and confirm with **OK**. Menu item **Wireless Setup** is now available in the menu **Network Settings**. Now you have to enter the network name (SSID) and network security key. If you do not have this information at hand, check the configuration settings of your router / access point or ask your network administrator.

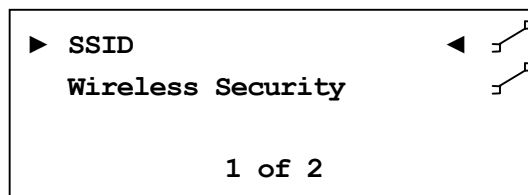

Note

- You have to set **Connection Type** to **Wireless (WiFi) 802.11**. Otherwise, menu item **Wireless Setup** will not be available.

Select **SSID** and set the network name.

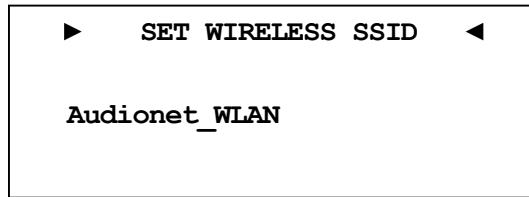

Please note that the network name (SSID) is case sensitive. Use the keys **▲** / **▼** to enter characters. With the **◀** / **▶** keys switch to the previous / next position. The cursor does not step forward automatically. Confirm your input with **OK**.

Now select your security mode.

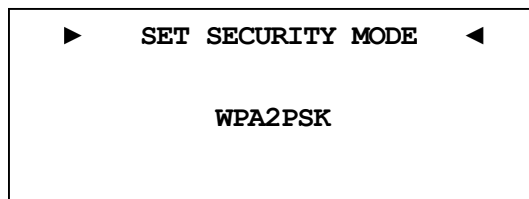

You have to choose between **WEP**, **WPAPSK** and **WPA2PSK**. All settings have to be confirmed with the **OK** key. As the WEP mode is out of date and unsecure, we only describe the setup of WPA2PSK security mode.

At last select menu item **WPA Pass Phrase** and enter your Wi-Fi security key. Example: **1x2y3z4a5b**

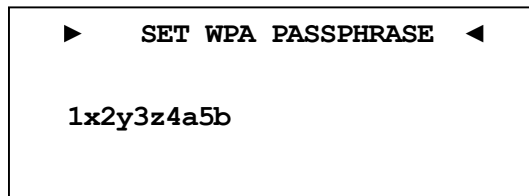

Confirm your input with **OK**. Network settings are entered and ready to be saved and applied.

Save network profile

Select **Save & Apply Settings** from the menu item **Manage Network** and confirm with **OK**. The new created network profile with all its settings is now saved and will immediately be applied.

8.4 Factory Default Reset

Use item **Factory Default Reset** from the main menu to reset the DNC completely or in parts to the factory default settings.

Press and hold key **set** on front panel or use key ***** of the Audionet Metal Remote Control *RC 2* to enter the main menu of your DNA 1. Select the menu item **Factory Default Reset** by using the **up / down** keys on the front panel or keys **▲ / ▼** of the remote control. Confirm your selection by pressing the **OK** key or press the **set** key on the front panel shortly.

Now select one of the five available menu items. Confirm your selection by pressing the **OK** key or press the **set** key on the front panel shortly.

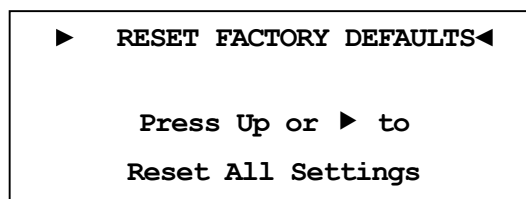

Press **up** at the front panel or the **►** on the remote control to start the reset procedure reverting the settings to the factory default values. After completing the reset procedure the DNC will power down and then perform a restart.

The individual menu items reset the following:

Reset All Settings	reset of all settings (except the settings of the network module). This function comprises the menu items Reset EQ Settings , Reset User Settings and Reset FM Stations in one single function.
Reset EQ Settings	reset all settings of the digital equalizer.
Reset User Settings	reset all User Settings 1 to 20.
Reset Network Module	reset the network module to factory defaults.
Reset FM Stations	reset all stored FM radio station presets.



Important

- Use cursor key **►** of the remote control or key **up** on the front panel to start the selected reset function.
- After resetting the network module to its factory defaults the connection to your network maybe lost and will only be recovered after the correct setup of the network configuration depending on your network.
- During the reset procedure the progress bar in the display will stop several times for a short moment. This is normal behaviour and no sign of any malfunction.

- If you execute one of the resets **Reset EQ Settings**, **Reset User Settings**, **Reset FM Stations** or **Reset All Settings**, the settings of the network module will be preserved. In order to reset the DNC completely to factory default settings you have to reset the network module after resetting the user settings (**Reset All Settings**).

8.5 User settings

The DNC is able to store 20 separate User Settings in its non-volatile memory.

Select this function with the keys on the front panel or with the Audionet Metal Remote Control *RC 2*. Furthermore, you may use the software Audionet RCP (see Audionet RCP user's manual).

A user setting contains all information, which is currently set, e.g. all EQ adjustments for all channels, complete speaker setup, volume offsets etc.

Example for usage: Set EQ to reduce amount of low frequencies and store it under the name of "night mode".

In normal operation mode, the display informs about the currently active User Settings:

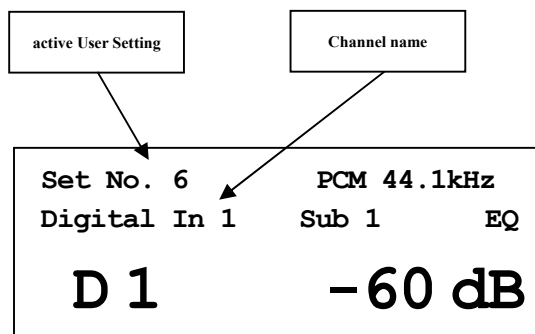

Note

- If no user setting is selected for current input channel, the display space for the active User Setting will be empty.
- If you load a User Setting for the current input channel and change than one of the channel setting, the display will no longer show this User Setting as the current input channel settings do not match the content of the User Setting.
- If you change the channel settings of the current input channel and the settings match one of the User Settings, then the display will show the name of this User Setting.

- If two or more User Settings in your library of 20 settings are exactly the same, then the display will automatically show always the User Settings with the lowest slot number.

8.5.1 Save user setting

Open the system menu with key ***** on the Audionet Metal Remote Control *RC 2* or push and hold **set** key on front panel for longer than 2 seconds. Navigate to menu item **Save User Setting** with **up / down** or **▲ / ▼** and push **set** or **OK**. The display reads:

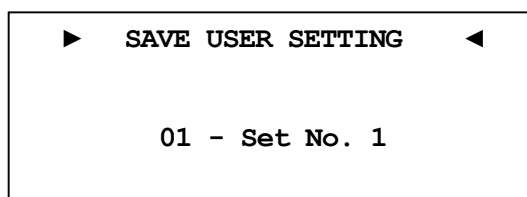

Use keys **up / down** or **▲ / ▼** to select the desired slot number where you would like to save the current setup. Push **set** or **OK** to acknowledge your selection. All current settings are saved to the selected slot.



Note

- If you save to a user setting all existing data will be overwritten.
- If you do not want to do the complete setup again, copy the desired user setting to a different slot and refine the settings, if necessary. For that purpose, load the existing user setting and store it to a different memory slot.

8.5.2 Load user setting

Open the system menu with key ***** on the Audionet Metal Remote Control *RC 2* or push and hold **set** key on front panel for longer than 2 seconds. Navigate to menu item **Load User Setting** with **up / down** or **▲ / ▼** and push **set** or **OK**. The display reads:

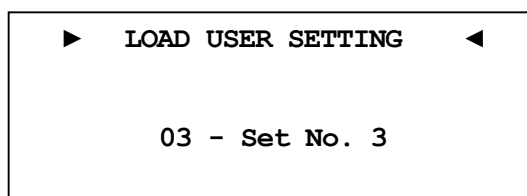

Use keys **up / down** or **▲ / ▼** to select the desired slot number which you would like to retrieve. Push **set** or **OK** to acknowledge your selection. All current settings are overwritten by the information previously saved to the selected slot.

8.6 Device info

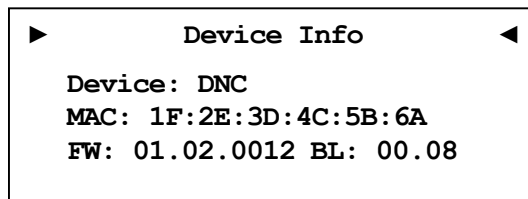

Here you will find the information about your hardware and software.

- MAC address
- Firmware version
- Boot loader version

Proceed to the second page by pressing the set, ◀/▶ or **OK**. The second page contains the following information:

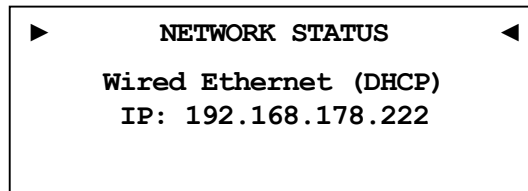

- Connection Type
- DHCP adjustment
- IP Address of the device

9 Additional information

9.1 Glossary

- **Switch:**

A switch is the central connection unit in a computer network. Every device is connected directly or indirectly to the switch.

- **Router:**

A router is sharing out data through the network. Usually the router device takes over other several features, such as Gateway-Server, DHCP-Server, DNS-Server, Switch, WLAN-Access Point, Modem, UPNP-AV and NAS via USB.

- **Access Point:**

An access point is an extension of a router. If a router is incapable of providing WLAN or its WLAN range is too limited, an access point can be connected to one of the LAN ports of the router and extend its functions.

- **Gateway:**

A gateway connects computer or router to other networks (internet) and controls these connections.

- **Modem:**

A modem establishes a connection between LAN and WAN.

Nowadays all devices mentioned above are built in one device, which is called **router**.

- **IP-Address:**

The IP-Address identifies a device in the network. It is comparable to a postal address. An IP address can only be used once within a network!
IPv4 (192.168.0.1) common standard
IPv6 (2001:db8::1428:57ab) future standard

- **DNS-Server:**

A DNS-Server translates textual request to IP addresses and provides simple communication to the internet.
(e.g. www.audionet.de is translated to "194.000.201.201")

- **Proxy:**

Proxy-Server is usually used in larger network facilities to guarantee more control and security to the network. Data transfer could be more efficient and speeded up. Home networks do not need a proxy.

- **LAN (Local Area Network):**

Localized network (home or company network)

- **Ethernet (cable):**

Ethernet is a technology that specifies hardware and software for wired data networks. An Ethernet connection offers a very good transmission rate and is to be preferred.

- **Power LAN (mains supply):**

With power LAN technology, you can connect Ethernet device through your mains supply. Transfer rate could be faster and more stable as a Wi-Fi connection. A disadvantage could be the harmonics produced by such devices polluting your mains supply.

- **WLAN (Wi-Fi):**

A Wi-Fi connection can be established very quickly, because you need no wire. The mayor disadvantages are the lower data transfer rate and the technical reliability. Physical structures or a large distance to the access point could harm the signal. We recommend wired connection.

- **WAN (Wide Area Network):**

Wide area network connections are used to connect to the internet.

- **Client:**

A client is a device, which has no administrative or special jobs in a network (e.g. PC, Notebook, DNC, iPad, etc.).

- **Server:**

Servers provide services to clients or other servers. A server could have multiple services running on it.

- **NAS (Network Attached Storage):**

A NAS is a network storage device, which makes data (e.g. music, pictures, video and documents) easily accessible to all network devices.

- **UPnP-MS (Universal Plug and Play – Media Server):**

UPnP is a defined network standard to connect clients and servers. It is very easy to use, because you do not have to set up a lot. Only connect and play. UPnP media servers are the most common way to provide data through a home network. A media server could also be part of a NAS or router or it could run as program on a Computer.

- **SSID:**

The term SSID is the short form of service set identifier and describes what is generally known as the name of the network. A wireless network must have a name, so that client devices are able to find, identify and connect to the network.

- **Passphrase:**

Every wireless network should be protected by a passphrase. Client devices are only able to access a protected wireless network if they pass the passphrase check. The passphrase is used for authentication and identification and is thus an important element of network security.

9.2 *Link collection*



Note

- We are not responsible for Wikipedia links. If you are looking for scientifically proven information, have a look at referenced science books in wiki article.

9.2.1 **Wireless security**

WPA: http://en.wikipedia.org/wiki/Wi-Fi_Protected_Access

WPA2: http://en.wikipedia.org/wiki/Wi-Fi_Protected_Access#WPA2

PSK: http://en.wikipedia.org/wiki/Pre-shared_key

EAP (Radius): <http://en.wikipedia.org/wiki/RADIUS>

http://en.wikipedia.org/wiki/Extensible_Authentication_Protocol

WEP: http://en.wikipedia.org/wiki/Wired_Equivalent_Privacy

9.3 *Equalizer filter type*

The following describes all the different EQ filters. All parameters are listed. Please follow the Wikipedia links for detailed information.



Note

- We are not responsible for Wikipedia links. If you are looking for scientifically proven information, have a look at referenced science books in the wiki article.

9.3.1 Peak-Filter

Gain range: -12 dB to +6 dB

Frequency range: 20 to 20000 Hz

Filter quality (Q): 0.3 – 8.0

Wikipedia: en.wikipedia.org/wiki/Band-pass_filter

9.3.2 High shelf filter

Gain range: -12 dB to +6 dB

Frequency range: 20 to 20000 Hz

Wikipedia: [en.wikipedia.org/wiki/Equalization_\(audio\)#Shelving_filter](https://en.wikipedia.org/wiki/Equalization_(audio)#Shelving_filter)

9.3.3 Low shelf filter

Gain range: -12 dB to +6 dB

Frequency range: 20 to 20000 Hz

Wikipedia: [en.wikipedia.org/wiki/Equalization_\(audio\)#Shelving_filter](https://en.wikipedia.org/wiki/Equalization_(audio)#Shelving_filter)

9.3.4 High-pass filter 2nd order

Attenuation at set Frequency: 3 dB

Filter quality (Q): 0.3 to 2.0

Attenuation below the set frequency is 40 dB per decade.¹

Wikipedia: en.wikipedia.org/wiki/High-pass_filter

9.3.5 Low-pass filter 2nd order

Attenuation at set Frequency: 3 dB

Filter quality (Q): 0.3 to 2.0

Attenuation above the set frequency is 40 dB per decade.

Wikipedia: en.wikipedia.org/wiki/High-pass_filter

9.3.6 High-pass filter 1st order

Attenuation at set Frequency: 3 dB

Attenuation below the set frequency is 20 dB per decade.

Wikipedia: en.wikipedia.org/wiki/High-pass_filter

9.3.7 Low-pass filter 1st order

Attenuation at set Frequency: 3 dB

Attenuation above the set frequency is 20 dB per decade.

Wikipedia: en.wikipedia.org/wiki/High-pass_filter

¹ Note: Technical considerations describe order-n filters with attenuation of $n \cdot 20 \text{dB/Decade}$, the corresponding description often used in music related topics is $n \cdot 6 \text{dB/Octave}$.

9.4 Error handling (FAQ)

Problem with internet radio streams:

A good, stable and fast connection to the internet, network is the most significant item. If your local conditions are fine, dropouts may be the problem of the radio stations broadcast. Switch to another station. If there is no problem it is perhaps a problem of the radio stations broadcast. Maybe it is overloaded.

Local problems could be an overload of your network, by downloads from the internet or data, which is moved through your network as well as other streaming (e.g. video). Reduce or quit connections to receive internet radio without dropouts. A bad Wi-Fi connection could also cause dropouts.

No control:

Switch off your device through the power button on the front panel. Then switch off the mains circuit breaker on the back panel. If there is no action while you press the power button on the front, directly take the mains circuit breaker on the back panel. Wait 20 to 30 seconds until you switch on again. If there is still a problem, contact your local dealer for support.

Which control has no function: If the remote control does not react, try the front panel keys, maybe it is only a problem of the remote control.

Remote control has no function:

Please check the batteries first and replace them if necessary.

Please check the position of the DIP switches (see section "*7.3 - Settings for Audionet DNC*" on page 30).

The software Audionet RCP does not establish a connection to DNC:

Restart your software and search for DNC again.

If this is without success, switch off the DNC (first stand-by, then mains switch on back panel) and wait 30 seconds. Start up your DNC again and switch to NET input. Wait until the display does not read **Booting** anymore. Now start your software Audionet RCP and search for DNC.

If there is still a problem, check your network and network settings or ask your network administrator for support. In case there is still a problem connecting the RCP to the DNC, try resetting the network module to factory defaults (main menu **Factory Default Reset**, menu item **Reset Network Module**) and re-configure your network settings if necessary.

9.5 *Security advice*



Important

- Avoid packaging material, especially plastic bags, to come into children's hands.
- Store and operate the unit in a dry room at a reasonable room temperature.
- Avoid moisture or any liquid to get into the unit.
- Place the device with enough circulation of air.
- **Do not cover**, e.g. with a blanket.
- **Do not open** the case. Unauthorized opening will cause loss of guarantee.
- Prevent short circuit to the outputs.
- Switch off all devices if you plug any cable.
- Use a dry cloth for cleaning.
- If massive trouble on the mains power grid is to be expected. Disconnect all devices from mains to prevent electrical overload. Disconnect antenna and network connections as well.

We would like to wish you many exciting listening experiences with your new Audionet product!

If you still have any questions, do not hesitate to ask your competent Audionet dealer.

9.6 Factory defaults

Option	Parameter
Global Setup	
Display	50%
Auto start	disabled
Power-Off Mode	normal
Serial Port	disabled
Channel Name	Digital In 1, 2 Optical In 1, 2 Streaming In USB Audio In FM-Tuner
Digital EQ	disabled
Trigger Out	disabled
Speaker Distance	Left / Right: 0 cm
Parametrical digital EQ	
	for all input channel
Gain	All channel, all MPEs: + 0 dB
Q	All channel, all MPEs: 1.00
Freq.	50,207,725,3147 & 10413 Hz
Network Setup	
DHCP	active
IP Address	192.168.178.222
IP Mask	255.255.255.000
Gateway	192.168.178.001
DNS	192.168.178.001
RCP Port	54321
Wireless Setup	
SSID	blank
Wireless Security	WPA2PSK
WPA Cipher Type	AES
WPA Pass Phrase	blank
WEP Authentication	open
WEP Key Index	0
WEP Key 0	blank
WEP Key 1	blank
WEP Key 2	blank
WEP Key 3	blank

9.7 Specifications

Function	network - compatible streaming client
Frequency response	Max. 96 kHz, depends on sample frequency
THD+N	< -104 dB @1 kHz
capacitance	> 44.000 µF
Input digital	2 SPDIF RCA jack, gold plated, Teflon isolated 2 SPDIF TosLink 1 XLR AES/EBU, 110 Ohm, gold plated, Teflon isolated (Neutrik) 1 USB (A) (for USB stick, ext. hard disk etc) 1 USB (B), USB Audio 2.0 (asynchronous) 1 RJ45 Ethernet 10/100 BASE-T 1 SMA Connector WLAN 1 Audionet Link, optical
Output	1 pair RCA jack, gold plated, Teflon isolated 1 pair XLR symmetric, gold plated (Neutrik) 1 Audionet Link, optical 1 3,5mm TSR connector mono Trigger Out (12V/5V, 50mA max.) 1 Sub D9 Serial interface RS232
Mains	220 V..240 V or 110..120 V , 50...60 Hz
Power consumption	Stand-By mode: < 1 W (Power-off mode normal , Serial Port disabled) 7 W (Power-off mode normal , Serial Port active) 11 W (Power-off mode quick-start) max. 85 W
Dimensions	width 430 mm height 70 mm depth 310 mm
Weight	8 kg
Design	Front: brushed aluminum, 10 mm, black anodized, white printing or aluminum natural, 10 mm, anodized, black printing Display: red or blue Cover plate: aluminum, black anodized Side plate: aluminum, black anodized Chassis: sheet steel, black varnished

Specials	<ul style="list-style-type: none"> - Audionet Metal Remote Control <i>RC 2</i> - Remote control with software - automatic mains phase detection - separated power supply for digital and analog section - fully DC coupled, no condenser in signal path - Audionet Link in-/output to remote control Audionet devices
Options	<ul style="list-style-type: none"> - External power supply Audionet EPS G2 or Audionet EPX

Errors and omissions excepted. Specifications and design are subject to changes without prior notice.

AUDIONET is a trademark of Idektron GmbH & Co KG

Engineered and produced by:
Idektron GmbH & Co. KG, Alboinstraße 36 - 42, 12103 Berlin, Germany
www.audionet.de
contact@audionet.de