

Audionet

PLANCK

Reference Compact Disc Player

User's Manual

Contents

I	Preface	5
1.1	Included items	6
1.2	Transport	6
2	Overview front panel	7
3	Overview back panel	8
4	Installation and power supply	9
4.1	Placement	9
4.2	Mains connection	10
4.3	Orientation of mains plug	10
4.4	Connecting the external power supply AMPERE	11
5	Outputs and inputs	12
5.1	Analog audio outputs	12
5.2	Digital audio outputs	13
5.3	Digital audio inputs	15
5.3.1	SPDIF inputs	16
5.3.2	USB audio input	17
5.4	Audionet Link	19
6	Usage	21
6.1	Switching on and off	21
6.2	Inserting and removing discs	23
6.3	Control elements on the front panel	25
7	Audionet Metal Remote Control	26
7.1	Key assignment Metal Remote Control	27
7.2	Changing the batteries	29
7.3	Settings for Audionet preamplifiers	30

8	Playing discs	31
8.1	Playable disc types	31
8.2	Basic playback control	33
8.3	Searching	33
9	Playback options menu	35
9.1	Time display	36
9.2	Repeat playback	37
9.2.1	Repeat disc	38
9.2.2	Repeat track	38
9.3	Random playback	39
9.4	Time search	40
9.5	Program playback	41
9.5.1	Edit a playlist	43
9.5.2	Playing a playlist	45
9.5.3	Delete a playlist	46
10	Global setup menu	47
10.1	Set digital input	49
10.2	Set digital output mode	49
10.3	Set display brightness	50
10.4	Set AutoOff	51
10.5	Set AutoPlay	52
10.6	Overview of factory defaults	53
11	Security advice	54
12	Technical data	55

I Preface

The Audionet Scientists Team and its leading scholars congratulate you on your purchase of this unit, sending cheers directly from our research and development center.

The predecessor model ART G3 is widely considered to be one of the best-sounding CD players ever made, boasting unique acoustic and design characteristics that convinced music-lovers around the world. An impressive list of test victories, distinctions, and awards testifies to the long and triumphant reign of the ART G3.

Curtain call for the third generation of CD player: the new PLANCK is nothing less than Audionet's final statement for reproducing the classical compact disc. At the same time, it also represents a thoroughbred high-end D/A converter. Its sound quality can be used via further digital systems, especially computers. This is possible via optical and electrical digital inputs.

The PLANCK is geared towards the requirements of classical stereophony. Expert connoisseurs of high-quality musical reproduction will find the product not only delivers the aural satisfaction they dream of, but even opens up previously unknown musical realms. Combining craft with precision and presence, PLANCK fulfils its makers' vision of pushing back the quality frontiers of classical CD playback to rival the standard of advanced high-resolution media. PLANCK is equipped with the potential to become a further milestone in audiophile acoustic art.

Even if you're an experienced aficionado of ultra-highend components, please start listening to your new Audionet PLANCK by reading this manual carefully before you plug it in. This will ensure you'll enjoy all functions of this unit without any compromise or potential disruption.

1.1 Included items

Included you will find the following items:

- The Compact Disc player Audionet PLANCK
- The Audionet Metal Remote Control
- The user's manual (that you are currently reading)
- One low resonance stabilizer made of black POM
- One standard mains cord
- One optical Toslink cable (Audionet Link)

1.2 Transport



Important

- Transport the PLANCK in the included package only.
- **Never** leave a CD or the stabilizer inside the PLANCK during transport. The sensitive mechanics of the drive could suffer damage.
- Always use the included bag to prevent scratches on the housing.
- Please allow the PLANCK to adapt to the climatic conditions in your listening room after the transport. As known for every optical device, low temperatures and humidity may cause the laser unit to be covered with condensation. Leave the drawer of the PLANCK open for several hours before switching the device on for the first time after transport.

2 Overview front panel

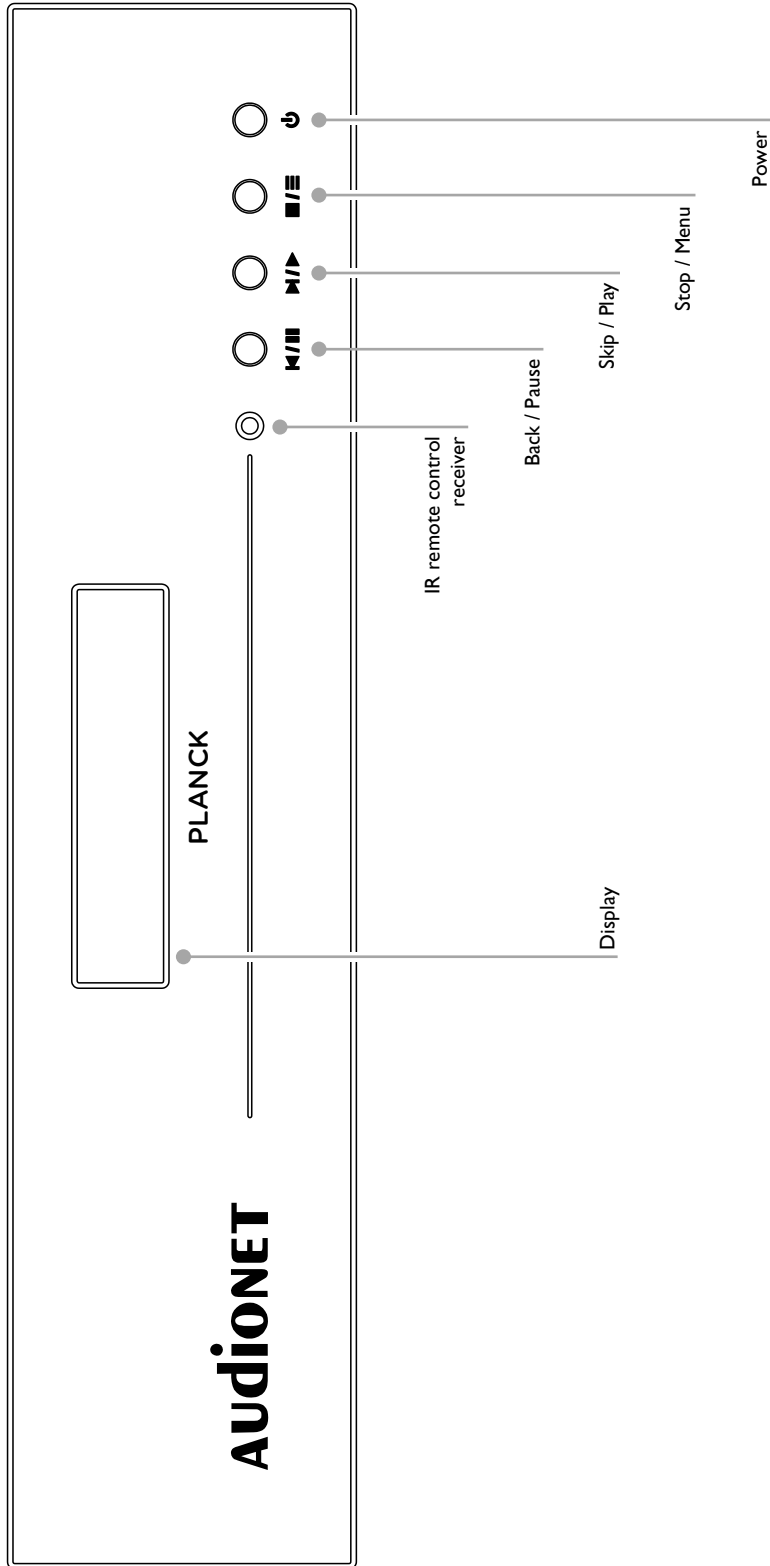

3 Overview back panel

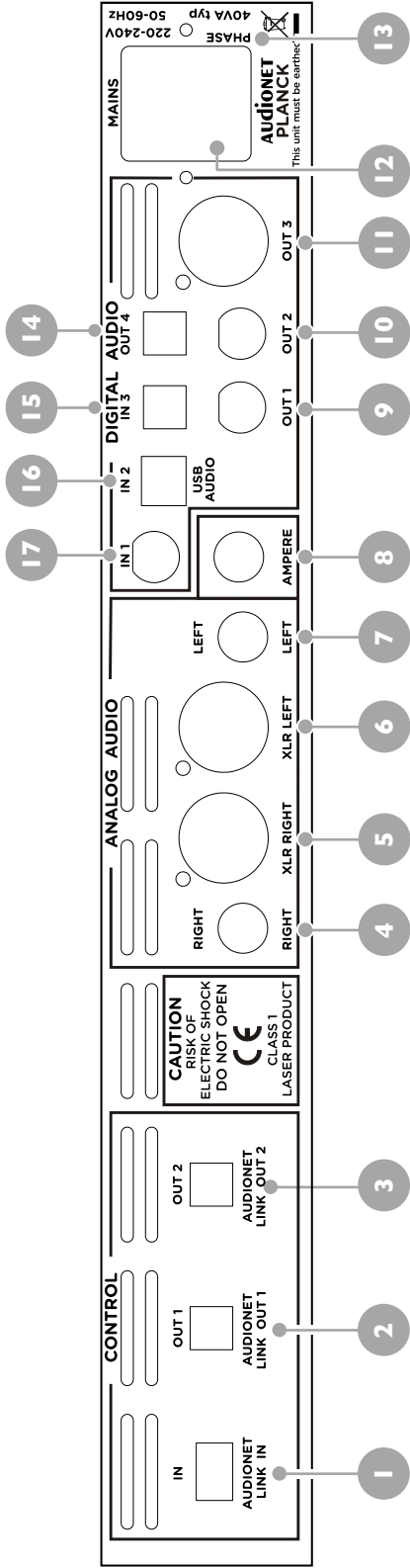

- | | |
|--|---|
| <ul style="list-style-type: none"> 1 Audionet Link input 2 Audionet Link output 1 3 Audionet Link output 2 4 Analog output Right (RCA/Cinch) 5 Analog output Right (balanced) 6 Analog output Left (balanced) 7 Analog output Left (RCA/Cinch) 8 Input for external power supply Audionet AMPERE | <ul style="list-style-type: none"> 9 Digital output 1 (RCA/Cinch) 10 Digital output 2 (RCA/Cinch) 11 Digital output 3 (AES/EBU) 12 Mains input 13 Marking mains phase 14 Digital output 4 (optical/Toslink) 15 Digital input IN 3 (SPDIF optical/Toslink) 16 Digital input IN 2 (USB Audio 2.0) 17 Digital input IN 1 (SPDIF electri-cal/Cinch) |
|--|---|

4 Installation and power supply



Important

- While connecting or removing the PLANCK to or from a pre-amplifier, both units and the corresponding power amplifiers have to be switched off to prevent damage of the PLANCK or any of the connected units.
- Please make sure that all cables are in absolute best conditions! Broken shields or short-cut cables could damage the PLANCK and any other connected unit.

4.1 Placement



Important

- It is recommended to place the PLANCK into a high quality rack or onto a stable table.
- Do not expose the unit to direct sunlight.
- Do not place the PLANCK in close range to heat sources like radiators.
- Do not place the PLANCK on top of other units that produce heat, especially not on top of power amplifiers, preamplifiers or similar. Both units could suffer damage from thermal overload.
- Do not use the unit in a place where it is exposed to vibrations.
- Do not place the unit close to loudspeakers or in corners of a room where it is exposed to high levels of sonic energy. This might reduce the sound quality of the unit.

4.2 Mains connection

The mains input 12* is located on the back panel of the PLANCK. Use the included mains cord to connect the unit to mains. If the use of a different power cord is preferred, make sure that it meets the electrical specifications and safety standards for your home country.



Important

- The electrical specifications of your home country must meet the electrical specifications printed on the back panel.
- The PLANCK is a Class I unit and must be earthed. Please ensure a stable earth connection. 'PHASE' 13 ('hot' pin) is marked on the back panel.
- Never pull the mains plug while the PLANCK is switched on! Always power the unit down to stand-by mode first, before pulling the mains cord from the mains input 12 on the back panel. Wait at least 3 minutes before re-plugging the unit to mains.

The PLANCK should only be disconnected from mains in cases of extended absence (like vacations) or if massive trouble on the mains power is to be expected. Pull the mains plug to completely disconnect the unit from mains.





4.3 Orientation of mains plug

The correct polarization of mains is important for reasons of audio clarity and stability. Please connect the mains cord so that the hot pin of the wall outlet is connected to the pin of mains input 12 marked with 'PHASE' 13 on the back panel of the unit.

* refer to numbers in section 'Overview back panel' on page 8.

4.4 Connecting the external power supply AMPERE

To use the optional external power supply AMPERE with your PLANCK follow these steps:

1. Make sure both – the PLANCK and the AMPERE – are switched off and disconnected from the mains.
2. Connect the AMPERE with the included cable to input jack  on the back panel of the PLANCK. The shape of the plug pre-vents any wrong polarity. The small 'nose' inside the plug has to face upwards. Now screw the ring of the plug onto the AMPERE input jack .
3. Connect **both** (!) units (PLANCK and AMPERE) to mains.
4. Switch the AMPERE on at its back panel first.
5. Use the  key at the front panel or the PLANCK key of the Audionet Metal Remote Control to switch the PLANCK on. The PLANCK is now ready for use, getting its power from the external power supply AMPERE.
6. To switch the PLANCK off into stand-by mode, use the  key on the front panel or the PLANCK key of the Audionet Metal Remote Control.



Important

- Never power the AMPERE on or off on its back panel while the PLANCK is still switched on or during playback.
- For further information regarding the external power supply AMPERE, please consult its user's manual.



Tip

- Use a high quality cable to connect the AMPERE to mains. The sound will improve.

5 Outputs and inputs



Important

- During connection or removal of the PLANCK to or from a preamplifier, both units and the corresponding power amplifiers have to be switched off in order to prevent any damage of the PLANCK or other connected units.
- Please make sure that all cables are in absolute best condition! Broken shields or short-cut cables could damage the PLANCK and any other connected device.

5.1 Analog audio outputs

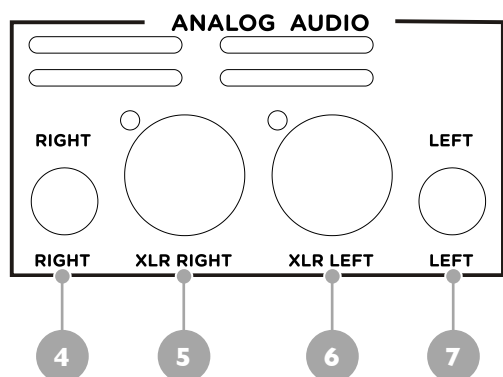

4 **RIGHT**

Analog audio output of the right channel (RCA / Cinch).

5 **XLR RIGHT**

Analog audio output of the right channel (balanced / XLR).

6 **XLR LEFT**

Analog audio output of the left channel (balanced / XLR).

7 **LEFT**

Analog audio output of the left channel (RCA / Cinch).

5.2 Digital audio outputs

Connect the analog outputs ④ and ⑦ of your PLANCK to your (pre-)amplifier using high quality interconnectors. Alternatively the balanced analog outputs ⑤ and ⑥ may be used in case your (pre-)amplifier has no analog RCA / Cinch inputs.

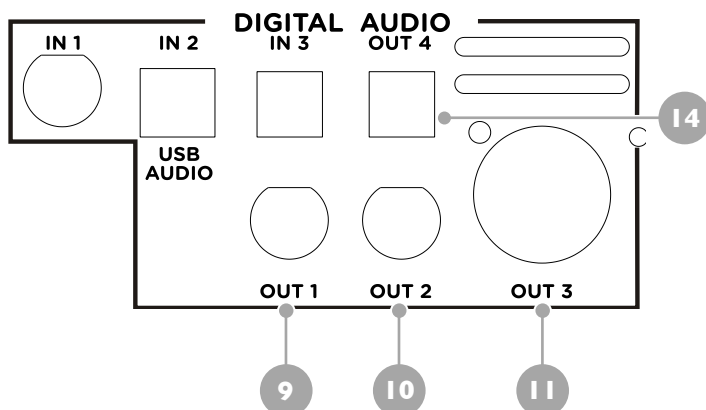

9 Digital output OUT 1 (SPDIF)

The digital audio signal is available at the digital output OUT 1 in the SPDIF format, depending on the setting of the option **Set Digital Output Mode** (refer to section 'Set digital output mode' on page 49).

10 Digital output OUT 2 (SPDIF)

The digital audio signal is available at the digital output OUT 2 in the SPDIF format, depending on the setting of the option **Set Digital Output Mode** (refer to section 'Set digital output mode' on page 49).

11 Digital output OUT 3 (AES/EBU)

The digital audio signal is available at the digital output OUT 3 in the AES/EBU format, depending on the setting of the option **Set Digital Output Mode** (refer to section 'Set digital output mode' on page 49).

14 Digital output OUT 4 (optical/TOSLink)

Use an optical (TOSLink) cable to connect the optical digital output OUT 4 of the PLANCK to any unit with an optical digital input. The output signal depends on the setting of the option **Set Digital Output Mode** (refer to section 'Set digital output mode' on page 49).



Important

- The option **Set Digital Output Mode** has to be set to **active** in order to use the digital outputs OUT 1 to OUT 4 of your PLANCK. All digital outputs of the PLANCK are switched off, if the setting **disabled** is selected (refer to section 'Set digital output mode' on page 49).

The following table does list the digital output formats, which are available at the digital audio outputs of the PLANCK.

Digital Output Mode	OUT 1 ⁹ SPDIF	OUT 2 ¹⁰ SPDIF	OUT 3 ¹¹ AES/EBU	OUT 4 ¹⁴ op- tical
enabled	44.1kHz / 16bit Stereo PCM	44.1kHz / 16bit Stereo PCM	44.1kHz / 16bit Stereo PCM	44.1kHz / 16bit Stereo PCM
disabled	no signal	no signal	no signal	no signal



Important

- **Do not** use any jumpers to short-circuit the digital outputs, if none of the digital outputs are used. Select the setting **disabled** of the option **Set Digital Output Mode** instead in order to switch all digital outputs off (refer to section 'Set digital output mode' on page 49).

5.3 Digital audio inputs

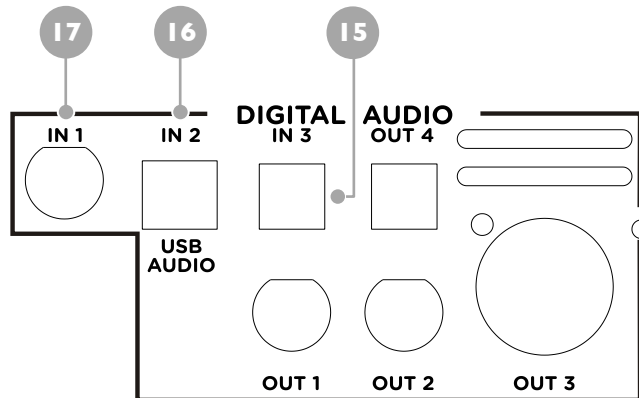

15 Digital input IN 3 (optical/TOSLink)

Digital audio input IN 3 for connecting digital devices (e.g. CD-Players, DAT recorders) via optical fibre cable to the PLANCK.

16 Digital input IN 2 (USB Audio 2.0)



Digital audio input IN 2 for connecting a computer for the playback of music and sound files using the sophisticated D/A-converter of the PLANCK. The PLANCK is recognized as 'USB Audio Device 2.0' by the operating system of your computer, e.g. Windows 7*. Use a standard audio player (e.g. Windows Media Player*) to play back your music through the PLANCK (refer to section 'USB audio input' on page 17).



17 Digital input IN 1 (SPDIF electrical/Cinch)

Digital audio input IN 1 for connecting digital devices (CD-Players, DAT recorders etc) via Cinch cable.

* 'Microsoft Windows' and 'Windows Media Player' are registered trademarks of Microsoft Corporation and were only used for information purposes.

5.3.1 SPDIF inputs

The digital input IN 1  as well as IN 3  may be used as SPDIF digital audio input, so that the sophisticated digital-to-analog converters of the PLANCK can transfer other digital sources as well (e.g. CD transports, DAT recorders).

1. Connect the electrical SPDIF input IN 1  to the SPDIF output of the source device using a suitable Cinch cable. In case that the source device is equipped with an optical SPDIF output, use an optical fibre (Toslink) cable to connect the source device to the optical input IN 3  of your PLANCK.
2. Switch the PLANCK on and select the digital input of your choice in the main menu (refer to section 'Set digital input' on page 49.)
3. Switch the source device on and start its playback.

The music of the source device is now played back by using the sophisticated digital-to-analog converters of the PLANCK.



Note

- The PLANCK supports the formats: PCM Stereo, sample rate 32 kHz up to 192 kHz, up to 24 bit resolution.



Important

- In order to listen to music via the SPDIF digital audio inputs of the PLANCK, make sure that the playback of a loaded disc is stopped first or no disc is loaded at all.
- You will only hear the audio from the disc during its playback with the PLANCK – no signals will be transported from the SPDIF audio interface, regardless which input is selected.
- Set the option **Set Auto Off** to **never off** in the Global Setup menu, if the SPDIF audio function of the PLANCK is used. Otherwise the unit will shut down automatically after 30 minutes (refer to section 'Set AutoOff' on page 51).

5.3.2 USB audio input

The USB Audio port IN 2  is a USB Type B socket, making it possible to connect the PLANCK directly to your PC by using a USB cable and the USB Audio 2.0 interface. The PLANCK is then used as the sound / playback device for your PC. The playback operates in asynchronous mode, i.e. the PLANCK uses its own clock generator and music is enjoyed without diminishing any sound quality.

The required driver needs to be installed on your PC in order to use USB Audio 2.0. The driver is already integrated in the operating system on Apple devices running OS X 10.6.4 or later as well as for the latest Linux systems. To receive the driver for Windows based systems, please contact us via email at service@audionet.de.



Note

- The driver is packed into a zip-file. To install the driver unpack the zip-file into a folder of your choice. Then open the chosen folder and start the installation process, executing the file 'setup.exe'.
 - All occurring security warnings can be confirmed with 'OK' during the installation process.
 - The PLANCK has to be connected with your PC via an USB cable during the installation process.
 - You can choose your PLANCK as sound device / playback device of your PC after the successful installation. For configuration, open the system preferences of your PC.
 - Pay attention to the length of the USB cable. If the cable is too long, it might diminish the sound quality or cause dropouts during playback.
1. Connect the USB Audio input IN 1  with a suitable USB cable (plug type A to plug type B) to an unused USB port of the computer that is compatible with USB 2.0 or above and supports the Full Speed USB protocol.
 2. Start the computer and switch on the PLANCK afterwards.

The PLANCK is recognized as newly added hardware by your computer. Depending on the computer's operating system, a warning might appear, asking to install a driver for the new hardware at the first connection of the PLANCK.

Also depending on the operating system, the PLANCK will be automatically set as standard device for sound playback. If necessary, please consult the manual to your operating system.

All music and sound files that are played on the computer are now sent to the sophisticated analog-to-digital converters of the PLANCK.



Note

- All volume and balance settings of the operating system or the sound application will still be active. When you hear no sound at all or if it has a low volume during the playback of sound and music files with your PLANCK, make sure that the operating systems or sound applications volume settings are not muted or set to a low level.
- The PLANCK supports the formats: PCM Stereo, sample rate 32 kHz up to 192 kHz, up to 24 bit resolution.



Important

- In order to listen to music via the USB Audio input of the PLANCK, make sure that the playback of a loaded disc is stopped first or no disc is loaded at all.
- Only audio from the disc is heard during CD playback with the PLANCK – no signals will be transported from the USB Audio interface.
- For the use of the USB Audio function of the PLANCK, set the Global Setup menu option **Set Auto Off** to **never off**. Otherwise the unit will shut down automatically after 30 minutes (refer to 'Set AutoOff' on page 51).

5.4 Audionet Link

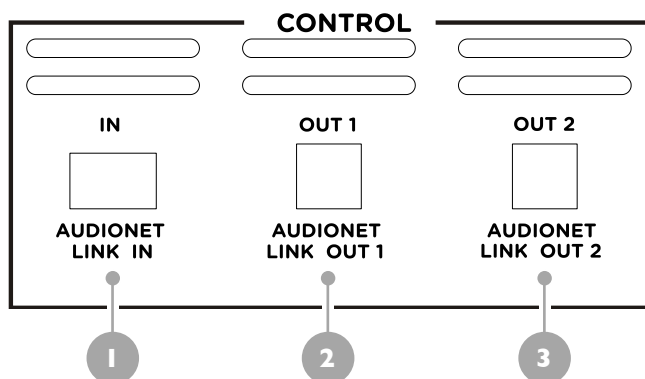

1 Control input IN

Audionet Link control input.

2 Control output OUT 1

Audionet Link control output 1.

3 Control output OUT 2

Audionet Link control output 2

(time-delayed in reference to control output OUT 1).

For your convenience, the PLANCK may be controlled remotely by an Audionet pre- or integrated amplifier using the 'Audionet Link' interface.

Connect the Audionet Link input ❶ of the PLANCK by a simple optical Toslink cable to the Audionet Link output of your Audionet preamplifier. As soon as the preamplifier is powered on or off at its front panel or by remote control, the PLANCK and all other units connected via Audionet Link will be switched on or off automatically as well.

For controlling further Audionet units automatically in a system by using the Audionet Link interface, connect the Audionet Link output OUT 1 ❷ or OUT 2 ❸ of the PLANCK to the Audionet Link input of the next Audionet unit (e.g. power amplifier) by using a simple optical Toslink cable.



Note

- The activation signal is passed to further Audionet units daisy chained to the Audionet Link output of your PLANCK with a slight delay to avoid all units powering up at the same time – preventing an overload of your mains fuse. First the control output OUT 1 ② is activated, afterwards OUT 2 ③ is switched on.
- The PLANCK may still be switched on or off manually at any time by using the ⏻ key on the front panel or the remote control.



Important

- If the option **Set AutoOff** has the value **shut off in 30 min**, the PLANCK will power down to stand-by mode automatically 30 minutes after the disc has stopped or after a key is used on the front panel as well as the remote control. This function works independently from a preamplifier that is connected via Audionet Link, i.e. the PLANCK shuts down automatically even if the preamplifier is still switched on (refer to section 'Set AutoOff' on page 51).

6 Usage

6.1 Switching on and off

Please make sure that the PLANCK is correctly connected to the (pre-)amplifier and the mains (refer to sections 'Installation and power supply' on page 9 and 'Outputs and inputs' on page 12). The display will light up with the Audionet logo, followed by a welcome message as soon as the PLANCK is connected to the mains. The display stays dark afterwards. The unit is in stand-by mode now.

Please make sure that the cover is closed before switching the unit on. Then power the PLANCK up by pressing the **⏻** key on the front panel. The PLANCK will show the message **WAKING UP...**

If the cover is still open, the display reads **OPEN**. If you activated the unit with closed cover and no inserted disc, the message **No Disc** will appear in the display after a short time.

Please refer to the sections 'Inserting and removing discs' on page 23 and 'Playing discs' on page 31 to read more on inserting, removing and playing discs.

If you would like to switch the unit off, press the **⏻** key on the front panel. The message **GOING TO SLEEP...** will appear on the display while powering down the unit. Afterwards the display stays dark – the PLANCK is in stand-by mode.



Note

- The PLANCK powers up automatically after it is connected to mains and starts playing the inserted CD, if the option **Set AutoPlay** has the values **Power on only** or **Power on & disc change** (refer to section 'Set AutoPlay' on page 52).
- Of course the PLANCK may be switched on or off at any time with the Audionet Metal Remote Control (refer to section 'Audionet Metal Remote Control' on page 26).

- If the unit is activated while the cover is still open, the PLANCK will issue the message:

```
▶           Attention:           ◀  
▶   Close cover before   ◀  
▶   switching on!!      ◀
```

Please close the cover. It is only possible to switch the unit on, if the cover is closed!

- If the cover is opened during power-up, the PLANCK interrupts the process with the warning:

```
▶           Attention:           ◀  
▶   Keep cover closed   ◀  
▶   during power up!!  ◀
```

Please close the cover first and switch the unit on again afterwards!

Using Audionet Link

The PLANCK may be controlled remotely by an Audionet pre- or integrated amplifier using the 'Audionet Link' interface.

Simply connect the Audionet Link input ① of the PLANCK by a standard optical Toslink cable to the Audionet Link output of your Audionet preamplifier. As soon as the preamplifier is powered on or off at its front panel or by remote control, the PLANCK and all other units connected via Audionet Link will be switched on or off automatically (refer to section 'Audionet Link' on page 19).



Note

- The activation signal is passed to further Audionet units daisy chained to the Audionet Link output of your PLANCK with a slight delay to avoid all units powering up at the same time – preventing an overload of your mains fuse. First the control output OUT 1 ² and afterwards OUT 2 ³ is activated.
- The PLANCK may still be switched on or off manually at any time by using the  key on the front panel or the remote control.



Important



- If the option **Set AutoOff** has the value **shut off in 30 min**, the PLANCK will power down to stand-by mode automatically 30 minutes after the disc has stopped or after a key is used on the front panel or remote control. This function is independent from a preamplifier connected via Audionet Link, i.e. the PLANCK shuts down automatically even if the preamplifier is still switched on (refer to section 'Set AutoOff' on page 51).

6.2 Inserting and removing discs

Open the cover on top of the PLANCK by pushing backwards using the handle. Set a disc onto the spindle with the printed side facing upwards. Fix the disc with the included stabilizer ('Puck'). Please ensure that the stabilizer locates the disc in a centred and leveled position.

Close the disc drawer. The display shows **CLOSE** and **Reading Disc...** in the next step. After reading the table of contents, the number of tracks and the total playing time of the disc is displayed in minutes and seconds:



Stop the playback by pressing the  /  key on the front panel or the  key of the Audionet Metal Remote Control before opening the cover. Please wait until the disc stops spinning, before removing the stabilizer in order to take out the disc.

As long as the cover remains open, the display reads **Open**.



Note

- The PLANCK needs a short moment to completely stop the disc, if the cover is opened during playback. Please wait until the disc stops spinning before removing it.
- The cover has to be closed completely in order to play back a disc.
- Always use the included stabilizer to fix the disc on the spindle. Otherwise the disc and the unit might suffer damage.
- **Never** load more than one disc at a time and do not use any additional stabilizers!
- Do not use any non-standard shaped discs available on the market since they might damage the unit.
- In case the option **Set AutoPlay** has the values **disc change only** or **Power on & disc change**, the PLANCK starts the playback automatically as soon as you insert a disc and close the cover (refer to section 'Set AutoPlay' on page 52).

6.3 Control elements on the front panel

The front panel has 4 keys for controlling the PLANCK (refer to section 'Overview front panel' on page 7). These keys control all basic playback functions as well as the setup options in the **Global Setup** menu.



Power the unit on or off.



Pressing this key shortly stops the playback. If it is pushed for at least 2 seconds, the **Global Setup** menu is entered and the key is then used to navigate through the menu items.



Push the key shortly to skip back to the beginning of the currently playing track. Press the key again to skip to the start of previous tracks. Hold it down the for at least 2 seconds to pause the playback. To continue playing, press the key long again.



Press this key once to start the playback or to skip to the beginning of the next track. Push it again to skip to the start of further tracks.

7 Audionet Metal Remote Control

Every function of the PLANCK is accessible by the Audionet Metal Remote Control. Additionally, it is able to control power, volume, muting and the input channel selection of an Audionet preamplifier.

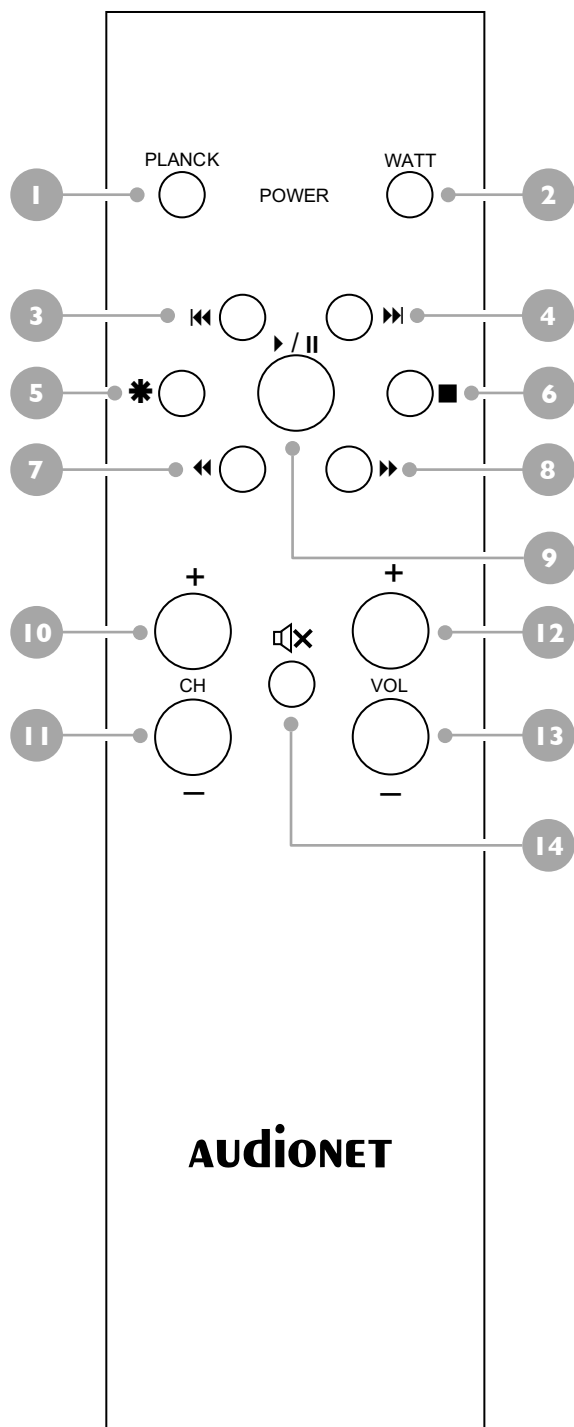

7.1 Key assignment Metal Remote Control

No.	Key	Function
1	PLANCK	Power the PLANCK on or off.
2	WATT	Power an Audionet preamplifier on or off.
3	⏮	Skip to previous track.
4	⏭	Skip to next track.
5	✳	Enter and navigate through the Global Setup & Playback Options menu.
6	■	Stop the playback.
7	⏪	Search backwards.
8	⏩	Search forwards.
9	▶ / ⏸	Start or resume the playback; press long for pause.
10	CH +	Select next input channel of Audionet preamplifier.
11	CH -	Select previous input channel of Audionet preamplifier.
12	VOL +	Increase volume of Audionet preamplifier.
13	VOL -	Decrease volume of Audionet preamplifier.
14	🔇	Mute / un-mute Audionet preamplifier.

1 Power key **PLANCK** for **PLANCK**

Use the power key **PLANCK** to switch the PLANCK on or off. This key has the same function as the  key on the front panel. If the PLANCK is in stand-by mode, **PLANCK** switches the unit on. If the PLANCK is already switched on, **PLANCK** powers the unit off into stand-by mode.

2 Power key **WATT** for Audionet preamplifier

Use the power key **WATT** to switch an Audionet preamplifier on or off. The key has the same function as the  button on the preamplifiers front panel. In case the Audionet preamplifier is in stand-by mode, **WATT** switches the unit on. If the Audionet preamplifier is already switched on, **WATT** sets the unit into stand-by mode.



3 Skip back key ◀◀

Skips back to the start of the current track. Press it again to skip to the start of previous tracks (refer to section 'Basic playback control' on page 33). It is also used for selecting options in the Global Setup menu (see section 'Global setup menu' on page 47) and the Playback Options menu (refer to section 'Playback options menu' on page 35).

4 Skip forward key ▶▶

Skips to the beginning of the next track (refer to section 'Basic playback control' on page 33). It is also used for selecting options in the Global Setup menu (see section 'Global setup menu' on page 47) and the Playback Options menu (refer to section 'Playback options menu' on page 35).

5 Setup key *

For entering and navigating through the Global Setup and Playback Options menu (see sections 'Global setup menu' on page 47 and 'Playback options menu' on page 35). This key works similar to the  /  on the front panel.

6 Stop key ■

Stops the playback (refer to section 'Basic playback control' on page 33) and deletes playlists (see section 'Delete a playlist on page 46).

7 Search backwards key ◀◀

Searches the disc backwards (refer to section 'Searching' on page 33). This key is also used for editing playlists (see section 'Edit a playlist' on page 43).

8 Search forwards key ▶▶

Searches the disc forwards (refer to section 'Searching' on page 33). This key is also used for editing playlists (see section 'Edit a playlist' on page 43).

9 Playback/Pause key ▶ / ||

Starts or resumes the playback. Press and hold for longer than 2 seconds to pause the playback at the current disc position. Press the key again to resume playback (refer to section 'Basic playback control' on page 33).

10 Channel up key CH +

Selects the next input channel of an Audionet preamplifier.

11 Channel down key CH -

Selects the previous input channel of an Audionet preamplifier.

I2 Volume up key VOL +

Increases the volume setting of an Audionet preamplifier.

I3 Volume down key VOL -

Decreases the volume setting of an Audionet preamplifier.

I4 Mute key

Mutes an Audionet preamplifier. Press the key again to return to the previous volume setting.

7.2 Changing the batteries

In order to change the batteries of your Audionet Metal Remote Control, remove the 6 Allen key head screws on the bottom side first.

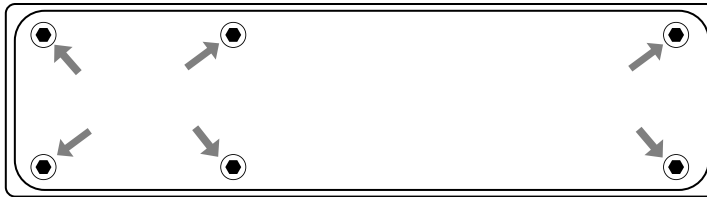

The battery compartment is located on the left side of the circuit board. 2 batteries type 'AAA' or 'Micro' with a voltage of 1.5 V are needed.

Battery compartment

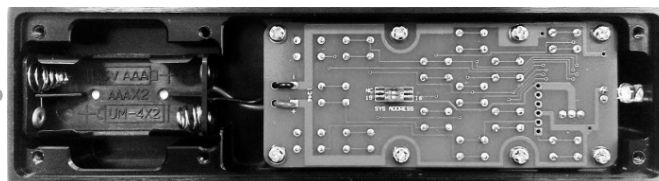

Important

- Please mind the batteries orientation while inserting a new pair. The correct orientation is printed onto the bottom of the battery compartment.

7.3 Settings for Audionet preamplifiers

The Audionet Metal Remote Control has 6 additional keys to control an Audionet preamplifier (see previous section 'Key assignment Metal Remote Control').

Depending on their type, Audionet preamplifiers use different system addresses as remote control code. A DIP switch on the circuit board of the Audionet Metal Remote Control is used to select the desired system address.

The remote control has to be opened in order to set the system address (refer to previous section 'Changing the batteries'). The DIP switch for selecting the system address is located here:

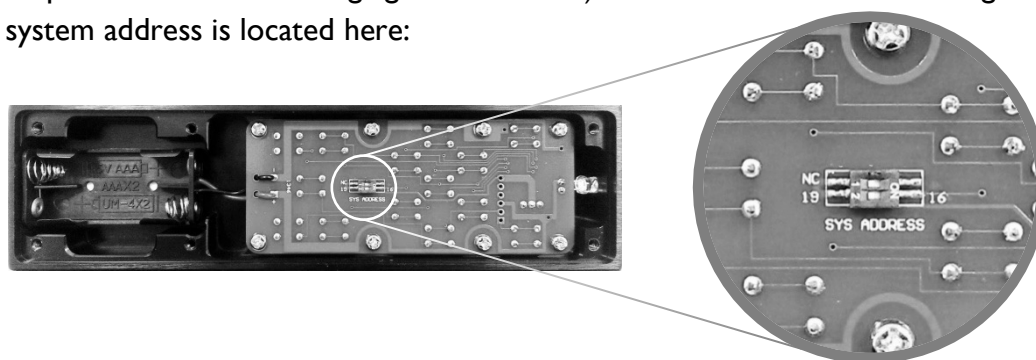

Set the DIP switch labelled 'SYS ADDRESS' to position '19' or '16' according to the following table:

Audionet preamplifier	Address
STERN, PRE G2, PRE I G3, WATT, SAM G2	19
DNA, DNP, DNA I	
MAP I	16



Note

- If not ordered explicitly otherwise, the Audionet Metal Remote Controls DIP switch is always preconfigured to setting '19'.
- Older models of Audionet preamplifiers use the system address '16'.



Tip

- If you own an Audionet preamplifier that is not listed in the table above and you don't know which system address it uses, simply try both settings.

8 Playing discs

If the PLANCK is not switched on yet, press the  key on the front panel or the **PLANCK** key on the Audionet Metal Remote Control to power the unit on.



Open the cover on top of the unit by sliding it backwards.

Put a disc onto the spindle with the printed side facing upwards. Fix the disc with the included stabilizer ('Puck'). Please ensure that the stabilizer locates the disc in a centred and leveled position.



Important

- **Never** load more than one disc at a time and do not use any additional stabilizers!

Press the  key on the front panel or the  key of the Audionet Metal Remote Control to start the playback.

8.1 Playable disc types

The following disc types are suitable for playback:

Audio-CD:



CD-R:



CD-R discs may be played, if they are recorded in the Audio-CD format. In some cases a playback might not be possible due to the characteristics of the disc or the recording conditions.



Important

- It is possible that some Audio CDs which are not compliant to the Red Book standard will not play correctly or not at all on the PLANCK. Particularly copy-protected CDs often violate the standard. Please notice the logos and notes on the CD or booklet.
- If you playback a DTS* Music CD with the PLANCK, **all analog outputs will always** send a high level noise **that might damage your speakers!**
- Make absolutely sure that you playback DTS Music CDs via a DTS-compatible AV (pre-)amplifier only. The AV (pre-)amplifier has to be connected to one of the digital outputs OUT 1 ⁹, OUT 2 ¹⁰, OUT 3 ¹¹, or OUT 4 ¹⁴ of the PLANCK.
- DTS Music CDs are usually marked:













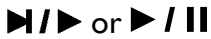

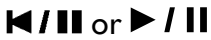
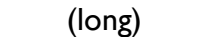
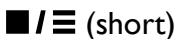
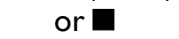
Note

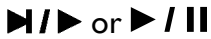
- The PLANCK is able to playback audio recorded on CD-G, CD-EXTRA and CD-TEXT discs

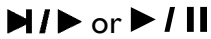
* DTS and the DTS Digital Surround are registered trademarks of Digital Theater Systems, Inc.

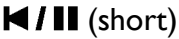

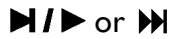

8.2 Basic playback control

The following table contains an overview on the basic playback functions. Advanced functions are explained in the following sections in detail.

Key	Function
 or  (short)	Start or resume the playback.
 or  (long)	Pause the playback.
 (short) or 	Stop the playback.
	Search backwards. Press  or  shortly to return to normal playback.
	Search forward. Press  or  shortly to return to normal playback.
 (short) or 	Skips to the beginning of the current track. Press again to get to the start of previous track.
 or 	Skip to the beginning of the next track.

8.3 Searching

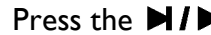
Searching is possible forward and backwards in several speeds.

1. Press  or  during playback to start the search mode.
2. Press the key again to increase the search speed.
3. Press the  or the  key to continue normal playback.

The display indicates both search direction and search speed.

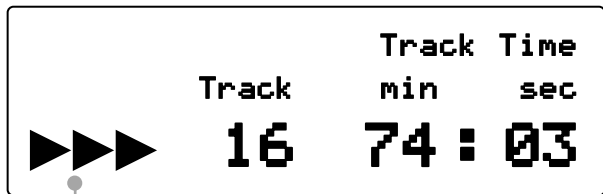

Search direction and search speed:

- ▶▶ forwards, slow speed
- ▶▶▶ forwards, medium speed
- ▶▶▶▶ forwards, high speed
- ◀◀ backwards, slow speed
- ◀◀◀ backwards, medium speed
- ◀◀◀◀ backwards, high speed



Note

- In order to start searching, the disc has to be in playback or pause mode.
- The search mode is suspended as soon as any other playback or menu function is selected.
- While searching in a specific direction, the search speed is reduced one step each time the search key for the opposite direction is pressed until reaching the normal playback speed.

9 Playback options menu

The **Playback Options** offers advanced functions during playback. Use the setup key * of the Audionet Metal Remote Control to skip through the items of the **Playback Options** menu. Use the ⏮ and ⏭ keys to select your desired setting.

Items of the Playback Options menu:

(* = Press the setup key for less than 2 seconds)

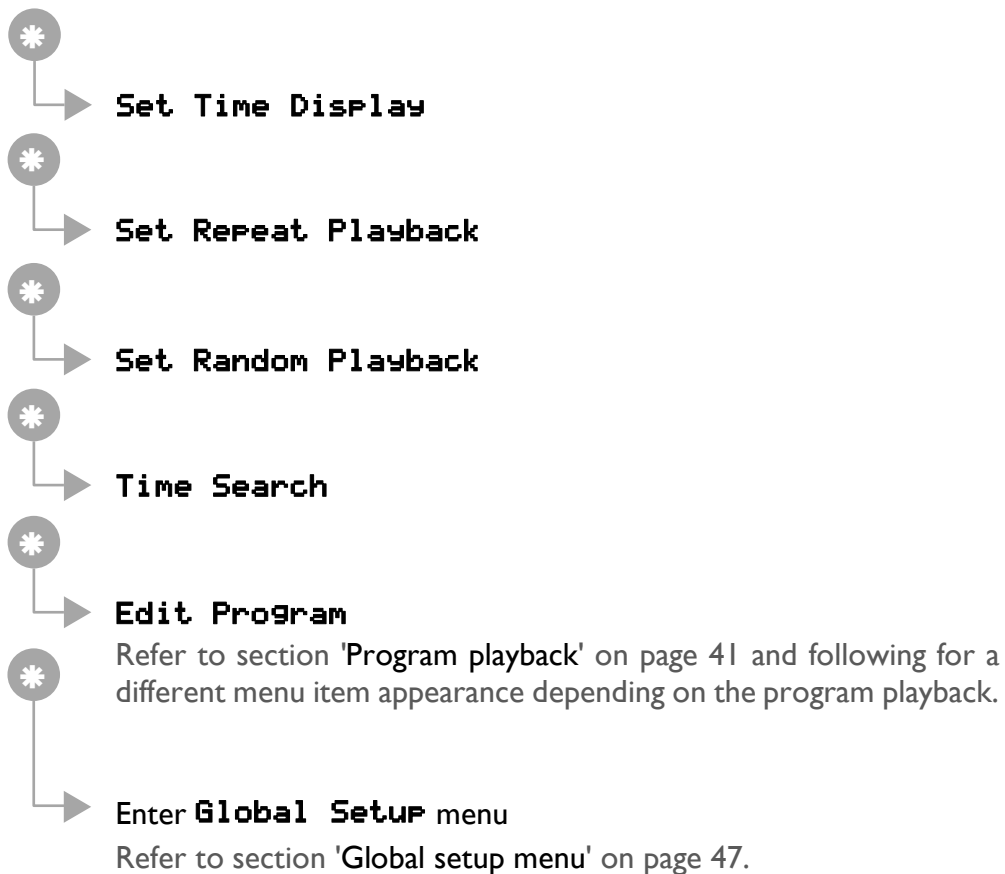

Note

- Hold the setup key * for more than 2 seconds to leave the menu.
- The PLANCK will leave the menu automatically after 12 seconds and return to the main display mask.
- The display brightness is set to 100% for better readability during adjustments. The user selected brightness level will be restored after leaving the menu.



Tip

- To enter the **Global Setup** menu directly, hold the setup key * for more than 2 seconds. Navigate to next menu item by short keystrokes on *.

9.1 Time display

Four different time display modes are available during the playback of a disc. Press the * key of the Audionet Metal Remote Control once to get to the **Playback Options** menu. The first item is **Set Time Display**. Use the ⏪ and ⏩ keys to select desired display mode.

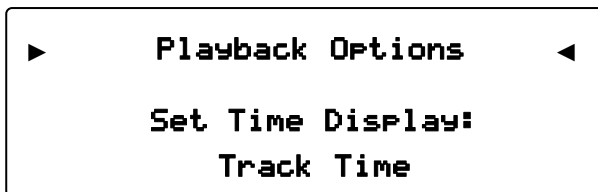

Four time display modes are available:

Track Time shows the time of the current track that is playing:

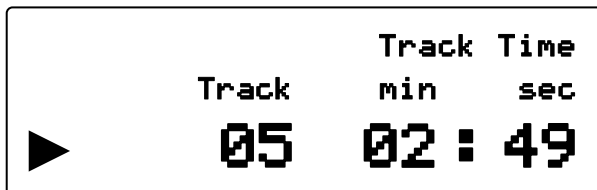

Track Remain shows the remaining playback time of the current track:

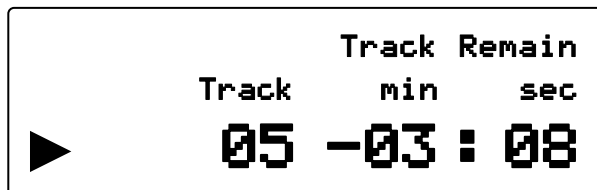

Total Remain shows the total remaining playback time of the current disc:

	Track	Total Remain	
		min	sec
▶	05	-42	: 36



Note

- The display shows the total remaining time of the playlist **Prog. Remain** during the playback of a playlist instead of the total remaining playback time of the disc **Total Remain**.

Total Time is the total playback time of the current disc:

	Track	Total Time	
		min	sec
▶	05	17	: 55



Note

- The display shows the total playback time of the playlist **Prog. Time** during the playback of a playlist instead of the total playback time **Total Time**.

9.2 Repeat playback

If you would like to repeat the currently inserted disc or just a single track, press the setup key ***** on the Audionet Metal Remote Control twice to get to the Playback Option **Set Repeat Playback**.

▶	Playback Options	◀
Set Repeat Playback:		
Repeat disabled		

Use the **⏮** and **⏭** keys to select the desired **Repeat Playback** function. Select **Repeat disabled** to switch off the **Repeat Playback** function.

9.2.1 Repeat disc

If you would like to repeat the currently inserted disc, select **Repeat Disc**. The display indicates the disc repeat mode with the symbol **↻ all**.

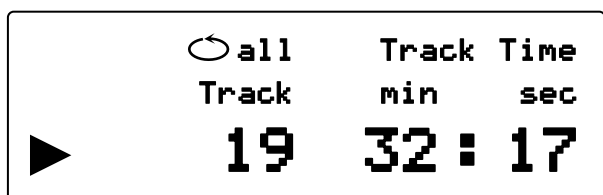

The playback resumes from the beginning of the disc after the end is reached. The disc will be repeated until the disc repeat function is turned off or the playback is stopped.

To deactivate the disc repeat function, select the option **Repeat disabled**. The repeat symbol **↻ all** is now removed from the display.



Note

- Only the tracks of the playlist are repeated instead of the whole disc, if a playlist is compiled.
- The repeat function may be switched on or off before or during a playback.
- In case the disc repeat and random play functions are activated both, all tracks are played back in random order until every track was played once. Afterwards the playback re-starts with a randomly chosen track.

9.2.2 Repeat track

Select the option **Repeat Track** for looping just a single track of the disc. The track repeat mode is indicated by the symbol **↻ one** in the display.

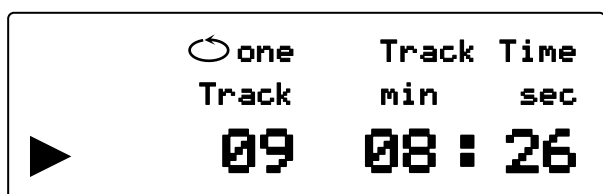

The current track will be looped until the track repeat function is switched off or the playback stopped.

Select the option **Repeat disabled** to deactivate the track repeat function. The track repeat symbol  **one** is vanishing from the display.



Note

- The repeat function may be switched on or off before or during a playback.
- In case the track repeat and the random play functions are activated both, only the current track will be repeated nonetheless.

9.3 Random playback

Use this function to play the tracks of a disc or playlist in a randomly order.

Press the setup key ***** on the Audionet Metal Remote Control three times to get to the Playback Option **Set Random Playback**.

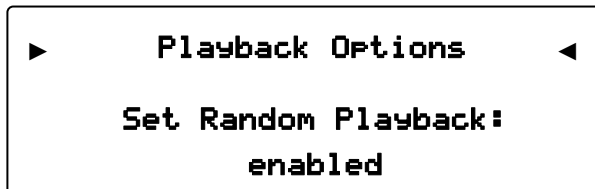

Use the **⏮** and **⏭** keys to enabled or disable the **Random Playback** function. If **Random Playback** is enabled, the display indicates an active random playback mode by the symbol **Random**:

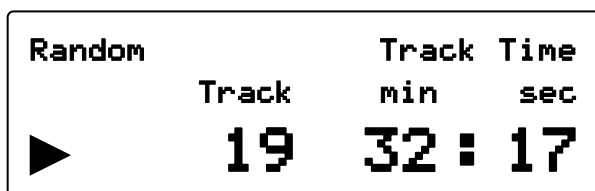

The text **Random** vanishes from the display, if **Random Playback** is disabled.



Note

- Only tracks of the playlist are played in a random order on a compiled playlist.

9.4 Time search

It is possible to access any time position on the disc directly. Press the setup key * of the Audionet Metal Remote Control four times to open the **Time Search** dialog in the display of the PLANCK. Enter the desired time in minutes and seconds. Use the ◀◀ and ▶▶ keys to select the right most digit of the displayed time. Press the ◀◀ key to shift all four digits one step to the left. Proceed this way until the desired time in minutes and seconds is shown in the display. Press the ▶ / || key to start or continue the playback at the entered time.



The display shows the user entered time and the corresponding track number.

Example:

You would like to start the playback at 47 minutes and 53 seconds. First, press setup key * 4 times to enter the **Time Search** dialog. Now use the ▶▶ button to enter a '4' as the right most digit. Press the ◀◀ key to shift the digits one step to the left. Push the ◀◀ key repeatedly until the right most digit is '7' and shift again with the ◀◀ button. Press the ◀◀ key repeatedly until the right most digit is a '5' and shift ◀◀ again. For the final digit press ▶▶ three times. You have now completely entered the desired time of 47 minutes and 53 seconds. Acknowledge your entry by pressing the ▶ / || key. The Playback starts at 47 minutes and 53 seconds.



Note

- If a time is entered that is not available on the disc, the number of the corresponding track is indicated as 00 in the display. If a playback is started now by using the ▶ / || key, the PLANCK will issue the warning

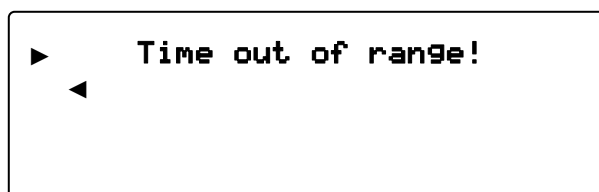

to inform that this time is not available on the disk and that a playback at the desired time is not possible.

- Correct a wrong time entry by simply typing in available and correct time values. The currently selected digit is always switched to the first digit. The other digits are shifted one digit to the left when you press the ◀◀ key. In this case, the first digit is always reset to '0'.

9.5 Program playback

Use this function to compile a playlist. Tracks will be played in the order they were programmed in the playlist.

Make sure the playback has stopped. Press the setup key * on the Audionet Metal Remote Control for five times to go to the Playback Option **Edit Program** for compiling a playlist. While in program mode, the display shows the following information:

```
▶          Edit Program          ◀
      Track 02 -> 19 of 19
    Prog. Time: 47 min 13 sec
      Add Track: 07
```

The first line of the display indicates that the PLANCK is now in the editing programs/playlists mode.

The second line shows the number of the current program step as well as the total number of program steps which are so far on the playlist. Additionally, the number of the track which is currently occupying the chosen program step is indicated. The playlist in the above example consists of 19 program steps in total and step 19 is occupied by track number 2.

The third line informs about the total playing time of the playlist. The total playing time is 47 minutes and 13 seconds in the above example.

The fourth line shows the number of the track which is currently selected to be added to the next program step of the playlist. In this example it is track no. 7.

First the desired track must be selected with the **⏮** and **⏭** keys of the Audionet Metal Remote Control to add it to the playlist. Check your current selection at line 4 of the display. Press **▶▶** to insert the the selected track into the playlist at the chosen step.

The change will appear in line 2 of the display and prove that the track was added successfully to the playlist: The total number of program steps was increased by one.

Now add all other tracks you like to the playlist as described above. The playback order corresponds to the programming order.



Note

- If you compiled a playlist and the program playback mode is active while the disc is stopped, the total program (playlist) playing time **Prog. Time** is indicated in the display instead of the total disc playing time **Total Time**.
- Of course, you may program a track multiple times into different program steps. The playlist is limited to a maximum of **99** program steps or a maximum playing time of **99** minutes and **59** seconds. If these maximum values are exceeded during the programming process, the PLANCK will issue the warning:

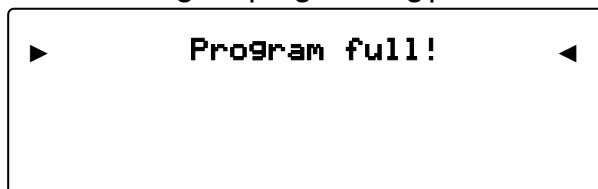

to inform that currently selected track cannot be added to the program.

- Please refer to section 'Edit a playlist' on page 43 to read more on erasing a single track from the playlist or how to insert a single track into an existing playlist.

9.5.1 Edit a playlist

An existing playlist may be edited at any time. Make sure the disc has stopped, then press the setup key * on the Audionet Metal Remote Control for five times to open the **Program Play Options**.

```
▶   Program Play Options   ◀  
  
edit      ->      press ◀◀  
disable   ->      press ■
```

Now press the ◀◀ key to enter the program/playlist edit mode. The display shows the dialog known from the process of adding tracks to the playlist (refer to section 'Program playback' on page 41):

```
▶   Edit Program   ◀  
Track 02 -> 05 of 16  
Prog. Time: 47 min 13 sec  
Add Track: 07
```

Pressing the ◀◀ key repeatedly skips through the program steps of the playlist and enlists the corresponding track numbers in the displays line 2 of the Edit Program dialog. Referring to the example above, the playlist consists of 16 program steps where step no. 5 is occupied by track 2.

As explained in the section 'Program playback' on page 41, tracks may be selected for adding them to the playlist by using the ◀◀ and ▶▶ keys of the Audionet Metal Remote Control. The currently selected track is indicated in line 3 of the display. This is track number 7 in the above example.

To add the selected track to the playlist, press the ▶▶ key on the Audionet Metal Remote Control. The selected track will be added to the playlist after the currently displayed program step. All further program steps will be shifted one step ahead. Track number 7 will be inserted after program step 5 (in this case track no. 2) in the example above. The playlist will then consist of 17 program steps. The total playing time of the playlist is indicated by line 3 of the display.

If a track shall be erased from the playlist, press the ◀◀ key on the Audionet Metal Remote Control repeatedly until the desired track is indicated in line 2 of the display.

Do erase the selected program step by pressing the **■** key now. The corresponding track is deleted from the playlist. All following program steps will be shifted a step back. The total number of program steps and the total playing time of the playlist are updated.

Example:

Your playlist consists of the following tracks in the order:

Program step	1	2	3	4	
Track no.	07	12	18	03	

You would like to insert track 9 between the tracks 12 and 18 (respectively program steps 2 and 3). Repeat pressing **◀** until line 2 of the display reads:

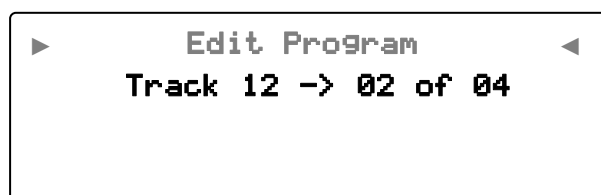

Press repeatedly **▶▶** until the displays line 4 reads:

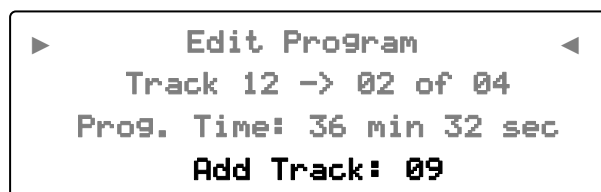

Insert track number 9 into the playlist by pressing the **▶▶** key. The playback order will now change to:

Program step	1	2	3	4	5
Track no.	07	12	09	18	03

Now you would like to erase track no. 18 from the playlist. Repeat pressing **◀** until line 2 of the display reads:



Remove track number 18 (respectively program step 4) from the playlist by pressing **■**. The new playback order is:

Program step	1	2	3	4	
Track no.	07	12	09	03	



Important

- This function is only available by using the Audionet Metal Remote Control!

9.5.2 Playing a playlist

As soon as the compiling process of the playlist is finished, the playback may be started by pressing the **▶ / ||** key on the Audionet Metal Remote Control or the **▶ / ▶** key on the front panel. The playback starts with the first track programmed in the playlist.

The display indicates a playlist playback by the symbol **Prog:** in the upper left corner. The number of the current program step is indicated directly below as well as the total number of program steps:

Prog:		Track	Time
02/17	Track	min	sec
▶	19	32	: 17

The disc track number 19 is playing in the above example. This is step 2 of 17 in the playlist.



Note

- If the random play function is active, the symbol **Prog:** is replaced by **Random** in the display. Nevertheless, the number of the current program step playing and the total number of program steps is still indicated.
- The playlist will still reside in the memory if the playback is stopped. Starting the playback again will resume the playlist.
- To erase a playlist, please refer to section 'Delete a playlist' on page 46.

- To stop playing a playlist during playback and to return to normal playback, press the setup key * of the Audionet Metal Remote Control for five times to get to the **Program Play Options**. Confirm disabling the Program Playback by using the ■ key. The PLANCK will continue to play in normal playback mode from the current track until the end of the disc.
- To restart the playback of the playlist which is still in the memory, stop the playback first (press ■). Then press the setup key * for five times to get to the **Program Play Options** again. Reactivate the program playback by pressing the ► key. The program playback will start right after the ►/|| or ►/► key is used.

9.5.3 Delete a playlist

In order to delete a playlist from the memory, press the ■/≡ key on the front panel or the ■ key on the Audionet Metal Remote Control while the playback has already stopped. The following dialog will be displayed:

```

▶          Delete Program?          ◀
  Yes      ->      Press STOP
  No       ->      Press any
                    other key

```

Press the ■/≡ or ■ key again to delete the playlist.

Press any other key or simply wait approx. 12 seconds until the PLANCK returns back to normal display mode if the playlist shall not be erased from the memory.

10 Global setup menu

Holding the **■/≡** key on the front panel for more than 2 seconds will enter the **Global Setup** menu. Press and hold the **■/≡** key for at least 2 seconds again to advance to the next menu item. After the last option the menu is dismissed. Use the **◀/||** and **▶/▶** keys to adjust an option.

Order of items in the Global Setup menu:

(**■/≡** = hold for at least 2 seconds)

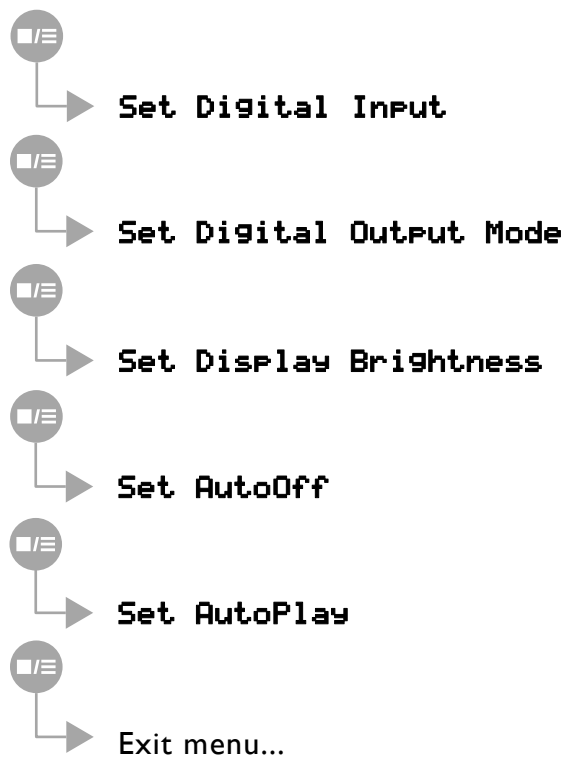

Tip

- All options of the **Global Setup** menu can be adjusted using the keys of the front panel. Using the Audionet Metal Remote Control might be much comfortable.
- Press and hold the setup key ***** for more than 2 seconds to enter the **Global Setup** menu directly. Navigate to the next menu item by short keystrokes on *****.

- Use the ⏮ and ⏭ keys of the Audionet Metal Remote Control to select an option. While navigating through the **Global Setup** menu, the ⏮/⏭ key on the front panel has the same function as the ⏮ button of the remote control. This applies to the ⏮/⏭ and ⏭ keys as well.



Note

- The **Global Setup** menu may be entered at any time by holding the ■/≡ or * key for at least 2 seconds – even during a playback.
- A short stroke on the ■/≡ key will still stop a running playback even during the use of the **Global Setup** menu (refer to 'Playing discs' on page 31).
- The PLANCK will automatically leave the **Global Setup** menu if no adjustments are made within the last 12 seconds.
- The display brightness is set to 100% during adjustments in the **Global Setup** menu for a better readability. The user selected brightness level will be restored after leaving the menu.
- If you power the unit off to stand-by mode, all current adjustments will be stored in the non-volatile memory of the PLANCK. The unit will still remember the settings after it is disconnected from the mains.

The options of the **Global Setup** menu are explained in detail through the following chapter.

10.1 Set digital input

Press the **■/☰** key once for at least 2 seconds to select the active digital input of the PLANCK. Use the **◀/||** and **▶/▶** keys to select the preferred digital input.

- disabled** All digital inputs of the PLANCK are switched off.
- IN 1 (electrical)** Use this option to activate the digital input IN 1 ¹⁷.
- IN 2 (USB Audio 2.0)** Use this option to activate the USB Audio 2.0 input IN 2 ¹⁶.
- IN 3 (optical)** Use this option to activate the optical input (Toslink) IN 3 ¹⁵.



Tip

- Use the setup key ***** of the Audionet Metal Remote Control to get to the menu item **Set Digital Input**. Use the **◀** and **▶** keys to select the preferred digital input.

10.2 Set digital output mode

Press the **■/☰** key long twice to adjust the output format of the digital outputs of the PLANCK. Use the **◀/||** and **▶/▶** keys to select the output format.

- active** All digital outputs are active. Use this setting for sending digital audio data from the PLANCK to a preamplifier that is equipped with a digital audio input, e.g. Audionet DNx or Audionet MAP I.
- disabled** All digital outputs are disabled. Select this option if none of the digital outputs of the PLANCK are used.



Important

- **Do not** short-circuit the digital outputs with any jumpers if they are not used. Select the setting **disabled** of the option **Set Digital Output Mode** instead in order to switch off all digital outputs.



Tip

- Use the setup key ***** of the Audionet Metal Remote Control to get to the menu item **Set Digital Output Mode**. Press the **◀** and **▶** keys to select the digital output format.

10.3 Set display brightness

Press the **■/≡** key long for three times to adjust the brightness of the display. Use the **◀/||** and **▶/▶** keys to set the desired brightness.



Important

- The long-term use of the maximum brightness value (setting to 100%) may cause extended signs of wear resulting in a decay of contrast or brightness of individual pixels in the display. Do not use the display with a brightness set higher than the factory default setting of 75% over a longer period of time.



Note

- If set to **Off**, the display is only illuminated during setup adjustments and will be deactivated several seconds after the last entry. This does also apply for direct track access, time search and skipping or searching.
- If a disc has stopped, the cover is opened or no disc is inserted while the cover remains closed, the PLANCK automatically activates the display saver 10 minutes after the last user interaction.
- During active display saver, all messages are displayed at 25% brightness and varying locations, changing every 12 seconds to prevent any 'burn-in' effects to the display.

- During active display saver, the total playing time is displayed in the form **16 Tracks 74min 03sec** while the disc has stopped.



Tip

- Use the setup key ***** of the Audionet Metal Remote Control to return to the option **Set Display Brightness**. Use the **◀** and **▶** keys to adjust the brightness of the display.

10.4 Set AutoOff

To adjust the automatic shut-off feature of the PLANCK, press the **■/≡** key long for four times. Use the **◀/||** and **▶/▶** keys to select the preferred function.

never auto shut off

The automatic shut-off feature is deactivated. The PLANCK stays powered on until it is switched off by the **⏻** key on the front panel, the remote control or by Audionet Link.

auto shut off in 30 min

The automatic shut-off feature is active. In case the PLANCK has stopped playback or the cover is left open for longer than 30 minutes without receiving any command from the keys on the front panel, the remote control or the Audionet Link, the unit will shut off to stand-by mode automatically.



Tip

- Use the setup key ***** of the Audionet Metal Remote Control to navigate to the **Set AutoOff** menu item. Pressing the **◀** or **▶** key activates or deactivates the automatic shut-off feature.

10.5 Set AutoPlay

To adjust the automatic playback feature of the PLANCK, press the **■/≡** key long for five times. Use the **◀/||** and **▶/▶** keys to select the preferred function.

never	The PLANCK never starts the playback automatically.
power on only	The Playback starts automatically if the unit is being connected to mains while a disc is inserted and the cover closed. Use this function to control the PLANCK by a timer.
disc change only	The playback starts automatically as soon as a disc is inserted, the cover is closed and the table of contents of the disc is read.
power on & disc change	Combination of the settings power on only and Disc change only .



Tip

- Use the setup key ***** of the Audionet Metal Remote Control to navigate to the **Set AutoPlay** menu item. Press the **◀** and **▶** keys to select the preferred setting.

10.6 Overview of factory defaults

The following settings are the factory default settings of the PLANCK:

Option	Setting
Set Digital Input	none
Set Digital Output Mode	disabled
Set Display Brightness	75%
Set AutoOff	auto shut off in 30 min
Set AutoPlay	never

II Security advice



Important

- Avoid packaging material coming into children's hands!
- Only store and operate the unit in a dry room at a reasonable room temperature!
- Avoid moisture, any liquids, dirt or small objects of getting into the unit!
- Set the unit up in a sufficiently ventilated environment!
- Do not cover the unit!
- Do not open the unit. Unauthorised opening will void warranty!
- Do not short-circuit the outputs!
- The PLANCK, the preamplifier and the corresponding power amplifiers have to be switched off while connecting or removing the PLANCK in order to prevent any damage to these units or other connected devices.
- Use a dry cloth for cleaning!

We would like to wish you many exciting listening experiences with your new Audionet product.

If you still have any questions, do not hesitate to ask your competent Audionet dealer or contact us directly.

I2 Technical data

Function	Compact Disc Player
Laser system	Semiconductor laser, 780 nm wave length
Converter	192 kHz / 24 Bit, Dual-Mono-DAC Multibit-Delta-Sigma method
Sample rate	44.1 kHz
Audio bandwidth	0 - 70,000 Hz (-3 dB) (reconstruction filter)
THD+N	< -107 dB (A-weighted) @ -6 dBFS
SNR	> 111 dB
Channel separation	> 134 dB @ 10 kHz
Outputs	<p>1 pair of RCA analog, gold plated, teflon insulated</p> <p>1 pair of XLR analog, gold plated</p> <p>2 RCA digital (SPDIF), gold plated, 600 mV_{ss} in 75 Ω</p> <p>1 AES/EBU digital, 110 Ω, gold plated</p> <p>1 SPDIF optical digital</p> <p>(All digital outputs can be de-activated!)</p> <p>2 Audionet Link, optical (Toslink)</p>
Inputs	<p>1 USB Type B socket, USB Audio 2.0</p> <p>1 Cinch, electrical digital (SPDIF)</p> <p>1 TosLink, optical digital (SPDIF)</p> <p>(all digital audio inputs up to 192 kHz / 24 bit)</p> <p>1 Audionet Link, optical (Toslink)</p>
Output impedance analog	33 Ω real
Output level analog	3.5 V _{RMS}
Mains	220..240 V or 110..120 V, 50..60 Hz
Power consumption	< 1 W Stand by, max. 40 W
Dimensions	<p>Width: 430 mm</p> <p>Height: 120 mm</p> <p>Depth: 360 mm</p>
Weight	23 kg

Finish	Front:	Brushed aluminium, 12 mm, anodised, text & symbols engraved
	Top/cover:	Brushed aluminium, 20mm, anodised
	Disc Drawer:	Brushed aluminium, 10mm, anodised
	Chassis:	Slate, aluminium, anodised, text printed
Color choices	Ultra:	C-32 (light bronze) with white display
	Classic:	Silver with blue display
		Silver with red display
		Black with blue display
Black with red display		
Features	Audionet Metal Remote Control in matching color (included)	
	D/A converter with USB Audio 2.0 / SPDIF digital input (elec. & optical)	
	Top loader, aluminium and slate casing	
	Massive disc drawer cover made of 10 mm aluminium, Teflon-bedded	
	Decoupling of the transport unit by Audionet Aligned Resonance technology	
	Special stabilizer made of POM	
	Separate power supplies for digital and analog sections	
	Audionet Intelligent Sampling technology	
	Discrete, extremely fast and stable filter and output stages	
	Fully DC coupled, no capacitors in the signal path	
	Disengageable digital outputs	
	Capable of de-emphasis processing	
Optional external power supply Audionet AMPERE for the analog section		

Errors and omissions excepted. Specifications and design are subject to changes without prior notice.

Audionet

is a trademark of Idektron GmbH & Co KG

Engineered and produced by:

Idektron GmbH & Co. KG, Alboinstrasse 36-42, 12103 Berlin, Germany

en.audionet.de

contact@audionet.de