

# ONKYO

AV RECEIVER

TX-SR3100  
TX-SR3100DAB

## Table of contents

### Speaker Installation

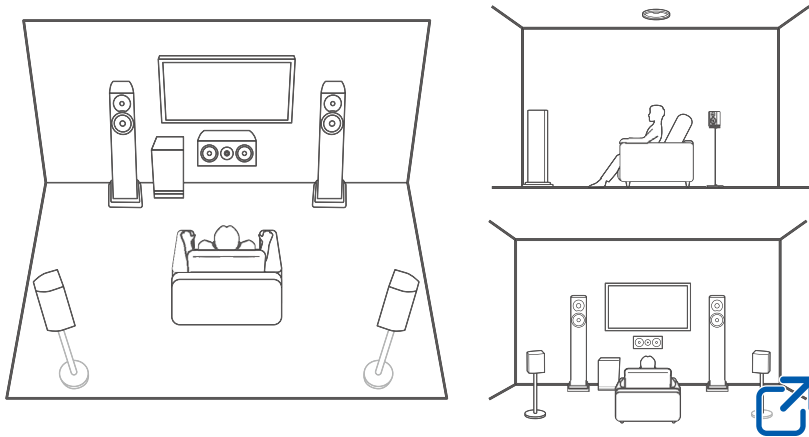

### Speaker Connections

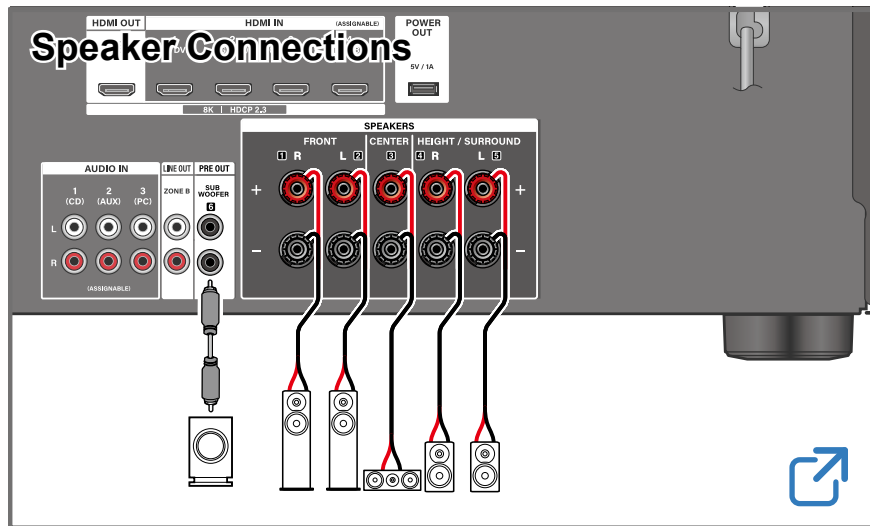

### Firmware Update



### Troubleshooting



### Supplementary Information

Features, etc. released in firmware updates



### Reducing the Power Consumption in Standby State

When the following functions are enabled, the power consumption in standby state increases. To reduce the power consumption in standby state, check each setting and set the functions to "Off".

- HDMI CEC ( →[p68](#) )
- HDMI Standby Through ( →[p68](#) )
- USB Power Out at Standby ( →[p71](#) )

Detailed contents (Next page)



<b>Before starting the procedure</b>	<b>5</b>	<b>Connecting Playback Devices</b>	<b>29</b>
<b>Firmware Update</b>	<b>6</b>	Connections to BD/DVD and GAME with HDMI jacks	29
Update Information of the firmware	6	Connecting an Audio Component	30
Checking the Firmware Version of the Unit	6	<b>Connecting an Integrated Amplifier or Transmitter (ZONE B)</b>	<b>31</b>
Firmware Update Procedure	6	<b>Connecting Antennas</b>	<b>32</b>
<b>Part Names</b>	<b>8</b>	<b>Connecting the Power Cord</b>	<b>33</b>
Front Panel	8	<b>Playback</b>	
Display	10	<b>Basic Operations</b>	<b>35</b>
Rear Panel	11	Turning the power on	35
Remote Controller	13	Selecting a source to play	35
<b>Inputting Characters</b>	<b>15</b>	Adjusting the volume	36
<b>Speaker Installation</b>		Using the linking function (HDMI CEC)	36
Setting Up the Speakers	16	Switching the display	37
<b>Speaker Connections</b>		<b>Listening Mode</b>	<b>38</b>
Speakers you can use with this unit and cable connections	20	Selecting a Listening mode	38
Connecting the Subwoofer	21	<b>BLUETOOTH® Playback</b>	<b>39</b>
<b>Connections</b>		<b>Listening To the Radio</b>	<b>40</b>
<b>Notes regarding connections with HDMI cables</b>	<b>26</b>	Listening To the AM/FM Radio	
Connections	26	(AM : North American, Taiwanese, Middle East, Australian and Asian models)	40
<b>Connecting the TV</b>	<b>27</b>	Using RDS	
To ARC/eARC TV	27	(European, Middle East, Australian and Asian models)	42
To Non-ARC TV	27		



Listening To DAB Digital Radio (European models only)	43
Presetting a Radio Station	44
<b>Adjusting the tone</b>	<b>45</b>
<b>Quick Menu</b>	<b>46</b>
<b>ZONE B Playback</b>	<b>48</b>
Connections	48
Playing Back	49
<b>Playing different audio and video</b>	<b>50</b>
Displaying Your Favorite Video on TV While Playing Music	50
<b>Setup</b>	
<b>Setup Menu</b>	<b>53</b>
Menu list	53
1. Input/Output Assign	55
2. Speaker	59
3. Audio Adjust	63
4. Source	65
5. Hardware	68
6. Miscellaneous	72
<b>Initial Setup with Auto Start-up Wizard</b>	<b>74</b>
Operations	74
1. Speaker Setup	75
2. ARC Setup	75

3. AccuEQ Room Calibration	76
----------------------------	----

## Troubleshooting

Before starting the procedure	78
When the unit is operating erratically	79
Troubleshooting	80

## Appendix

Speaker Layouts and Selectable Listening Modes	89
LISTENING MODE buttons and Selectable Listening Modes	91
Input Formats and Selectable Listening Modes	92
Listening Mode Effects	95
Speaker Combinations	99
<b>General Specifications</b>	<b>100</b>



# Before starting the procedure

## ■ What's in the box

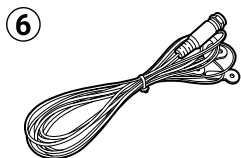
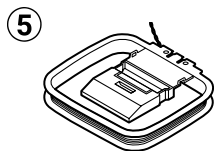
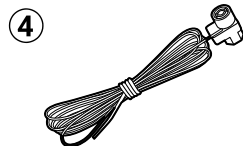
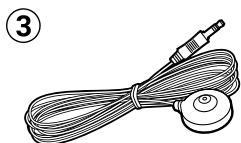
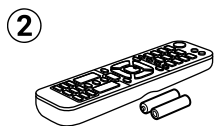
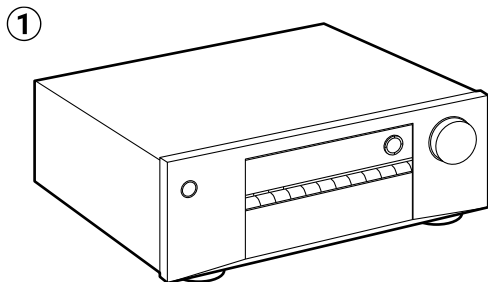

- ① Main unit (1)
- ② Remote controller (RC-970R) (1), Batteries (AAA/R03) (2)
- ③ Speaker setup microphone (1)
  - Used during Initial Setup.
- ④ Indoor FM antenna (North American, Taiwanese, Middle East, Australian and Asian model) (1)
- ⑤ AM loop antenna (North American, Taiwanese, Middle East, Australian and Asian model) (1)
- ⑥ DAB/FM antenna (European models) (1)
  - Initial Setup Guide (1)

\* This is an online user manual. This is not supplied with the product.

## ■ Note

- Connect speakers with an impedance of 4  $\Omega$  to 16  $\Omega$ .
- The power cord must be connected only after all other connections are completed.
- We will not accept any responsibility for damage arising from the connection with equipment manufactured by other companies.
- Details on the firmware update will be posted on our website and through other means at a later date.
- The illustrations in this manual use those of North American models unless otherwise mentioned.
- Specifications and appearance are subject to change without prior notice.



# Firmware Update

**Disclaimer:** The program and accompanying online documentation are furnished to you for use at your own risk.

Our company will not be liable and you will have no remedy for damages for any claim of any kind whatsoever concerning your use of the program or the accompanying online documentation, regardless of legal theory, and whether arising in tort or contract.

In no event will our company be liable to you or any third party for any special, indirect, incidental, or consequential damages of any kind, including, but not limited to, compensation, reimbursement or damages on account of the loss of present or prospective profits, loss of data, or for any other reason whatsoever.

## Update Information of the firmware

For the latest firmware contents and the firmware version, visit website.

## Checking the Firmware Version of the Unit

To confirm the firmware version of your product, press the  SETUP button on the remote controller, and refer to "Miscellaneous" - "Firmware Update" - "Version" ( → [p73](#)).

## Firmware Update Procedure



Updating can take about 20 minutes. Existing settings are maintained.

### Updating via USB

- Save only the updating data on the USB storage device. Delete any other data.
  - While updating the firmware, do not do the following:
    - Disconnecting and reconnecting cables, USB storage device, speaker setup microphone or headphones, or performing operations on the unit such as turning the power off
  - Prepare a 1 GB or larger USB storage device. The format of USB storage devices supports FAT16 or FAT32 file system format.
    - Media inserted into a USB card reader may not be used for this function.
    - USB storage devices equipped with the security function are not supported.
    - USB hubs and USB devices equipped with the hub function are not supported. Do not connect these devices to the unit.
  - If "HDMI CEC" is set to "On", set it to "Off".
    - Press  SETUP. Next, select "Hardware" - "HDMI" and press ENTER, then select "HDMI CEC" and select "Off".
- \* Depending on the USB storage device or its content, long time may be required for loading, the content may not be loaded correctly, or power may not be supplied correctly.
- \* Our company will not be liable whatsoever for any loss or damage of data, or storage failure arising from the use of the USB storage device. Please note this in advance.
- \* The descriptions may differ from the actual on-screen displays, however, operations and functions are the same.



## Update

1. Connect the USB storage device to your PC.
2. Download the firmware file from the our company's website to your PC and unzip.  
Firmware files are named as below.  
ONKAVR\*\*\*\*\_R\*\*\*\*.zip  
Unzip the file on your PC. The number of unzipped files and folders varies depending on the model.
3. Copy all unzipped files and folders to the root folder of the USB storage device.
  - Make sure to copy the unzipped files.
4. Connect the USB storage device to the USB port of this unit.
  - If an AC adapter is supplied with the USB storage device, connect the AC adapter, and use it with a household outlet.
  - If the USB storage device has been partitioned, each section will be treated as an independent device.
5. Turn on the power of the unit and wait for about 20 seconds.
6. Press the  SETUP button on the remote controller, select "Miscellaneous" - "Firmware Update" - "Update via USB" in order and press ENTER.
  - If "Firmware Update" is not available for selection, wait until the system has started.
  - "Update via USB" will not be available for selection if the firmware of the unit is the latest.
7. Press ENTER with "Update" selected, and start update.  
"Completed!" is displayed when updating is completed.
  - Check the progress on the display of the unit.
  - During the update, do not turn the power off, or disconnect or reconnect the USB storage device.
8. Disconnect the USB storage device from the unit.
9. Press  ON/STANDBY on the main unit to turn the unit into standby mode.  
The process is completed, and your firmware is updated to the latest version.
  - Do not use  ON/STANDBY on the remote controller.

## If an Error Message is Displayed

If an error occurs, "\*-\*-\* Error!" is displayed on the display of the unit. ("\*" represents an alphanumeric character.) Refer to the following descriptions and check.

### Error Code

- \*-01, \*-10:  
The USB storage device cannot be recognized. Check if the USB storage device or USB cable is securely inserted to the USB port of the unit. Connect the USB storage device to an external power source if it has its own power supply.
- \*-05, \*-13, \*-20, \*-21:  
The firmware file is not present in the root folder of the USB storage device, or the firmware file is for another model. Retry from the download of the firmware file.
- Others:  
After removing the power plug once, insert it to the outlet, and then start the operation from the beginning.



# Part Names

## Front Panel

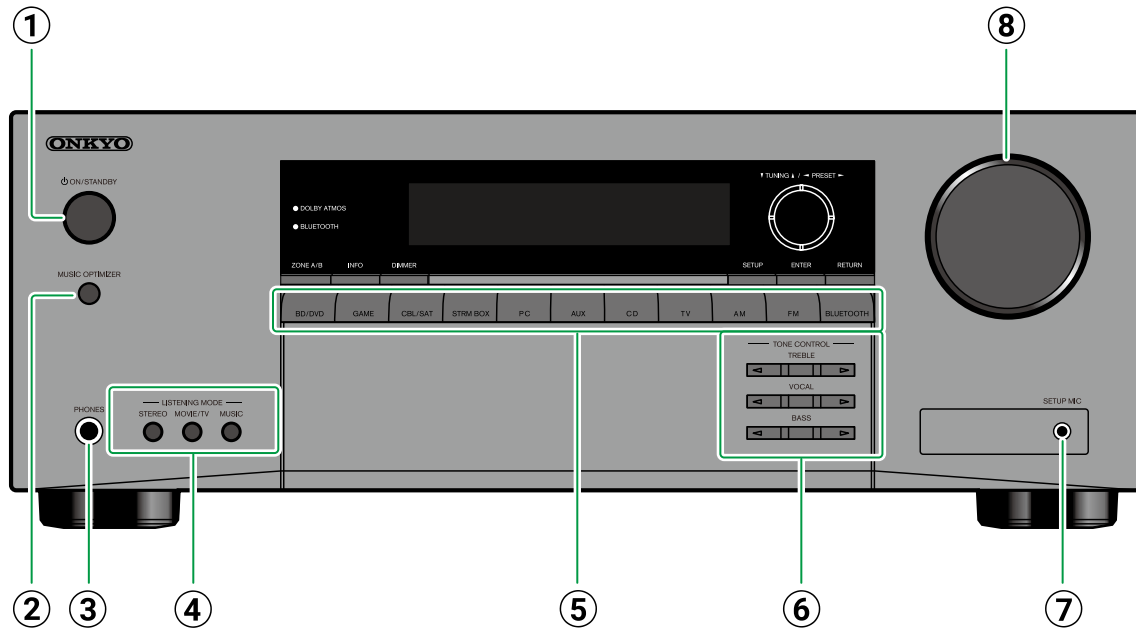

⑧ MASTER VOLUME

- ① **ON/STANDBY button**
- ② **MUSIC OPTIMIZER button:** Turns on/off the Music Optimizer function that improves the quality of the compressed audio.
- ③ **PHONES jack:** Connect headphones with a standard plug (ø1/4"/6.3 mm).
- ④ **LISTENING MODE button:** Switches the listening mode ( →p38) by pressing "STEREO", "MOVIE/TV" and "MUSIC" repeatedly.
- ⑤ **Input selector buttons:** Switches the input to be played.
- ⑥ **TONE CONTROL button:** You can adjust the sound quality. Press ◀/▶ LEFT/RIGHT for the "TREBLE"/"VOCAL"/"BASS" item you want to adjust. ( →p45)
- ⑦ **SETUP MIC jack:** Connect the supplied speaker setup microphone. ( →p76)





# Front Panel

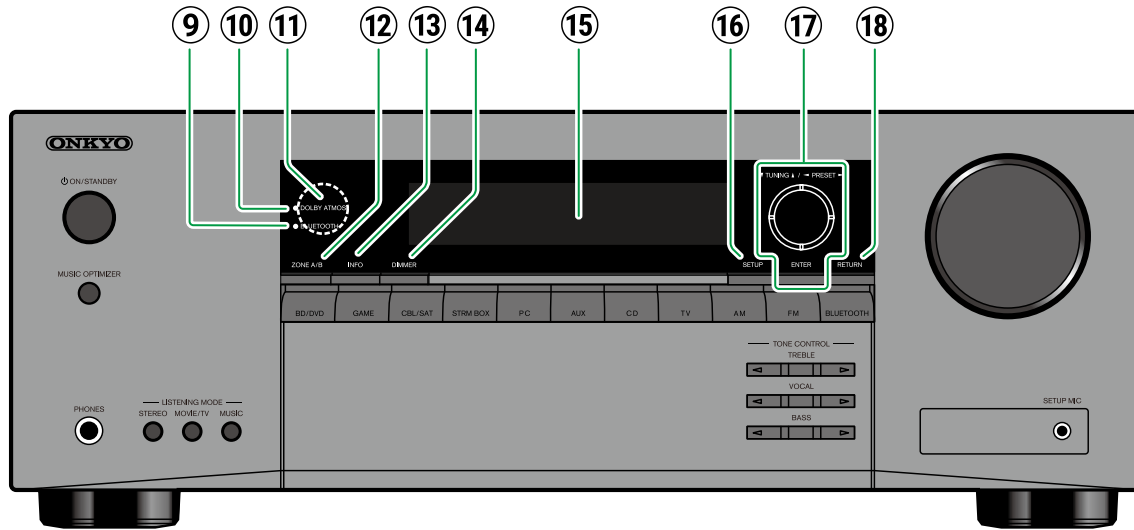

- ⑨ **BLUETOOTH indicator:** Lights up when this unit and a BLUETOOTH-enabled device are connected.
- ⑩ **DOLBY ATMOS indicator:** Lights up when Dolby Atmos signals are reproduced in appropriate listening mode.
- ⑪ **Remote control sensor:** Receives signals from the remote controller.
  - The reception range of the remote controller

is within a distance of approx. 16'5 m, and an angle of 20° in vertical direction and 30° to right and left.



- ⑫ **ZONE A/B button:** Selects an audio output destination from among "ZONE A", "ZONE B" and "ZONE A+B". (→p49)
- ⑬ **INFO button:** Switches the information on the display and is used to operate RDS (European, Middle East, Australian and Asian models)

- (→p42)
- ⑭ **DIMMER button:** Switches the brightness of the display with three levels. It cannot be turned off completely.
- ⑮ **Display** (→p10)
- ⑯ **SETUP button:** You can display advanced setting items on the TV and the display to have a more enjoyable experience with this unit. (→p53)
- ⑰ **Cursor ▲ / ▼ / ◀ / ▶ UP/DOWN/LEFT/RIGHT buttons and ENTER button:** Select an item with the cursors, and press ENTER to confirm your selection. When using TUNER, use them to tune in to stations. (→p40)
- ⑱ **RETURN button:** Returns the display to the previous state while setting.

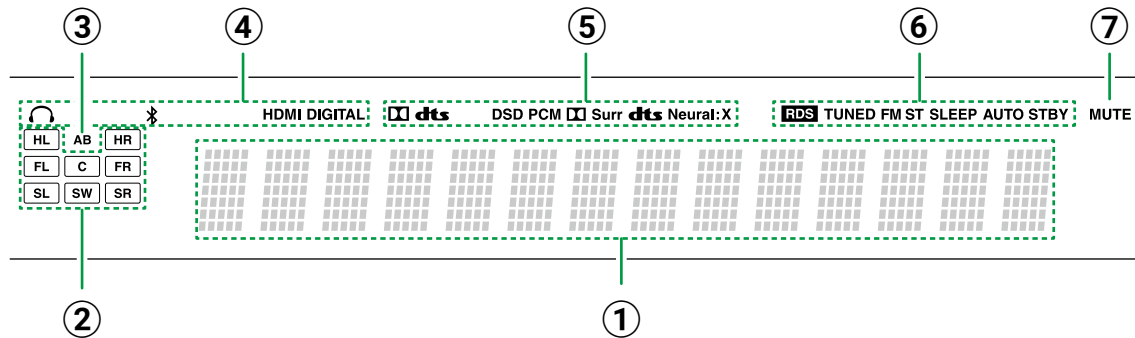

# Display



- ① Displays various information of the input signals.
- ② **Speaker/Channel display:** Displays the output channel that corresponds to the selected listening mode.
- ③ Displays the audio output destination.  
**A:** Audio is output only to ZONE A.  
**B:** Audio is output only to ZONE B.  
**AB:** Audio is output to both ZONE A and ZONE B.
- ④ Lights in the following conditions.  
: Headphones are connected.  
: Connected by BLUETOOTH.  
**HDMI:** HDMI signals are input and the HDMI input is selected.  
**DIGITAL:** Digital signals are input and the digital

- input is selected.
- ⑤ Lights according to the type of input digital audio signal and the listening mode.
- ⑥ Lights in the following conditions.  
**RDS** (European, Middle East, Australian and Asian models): Receiving RDS broadcasting.  
**TUNED:** Receiving DAB (European models)/AM (North American, Taiwanese, Middle East, Australian and Asian models)/FM radio.  
**FM ST:** Receiving FM stereo.  
**SLEEP:** Sleep timer is set.  
**AUTO STBY:** Auto Standby is set. ( →[p71](#))
- ⑦ Blinks when muting is on.



# Rear Panel

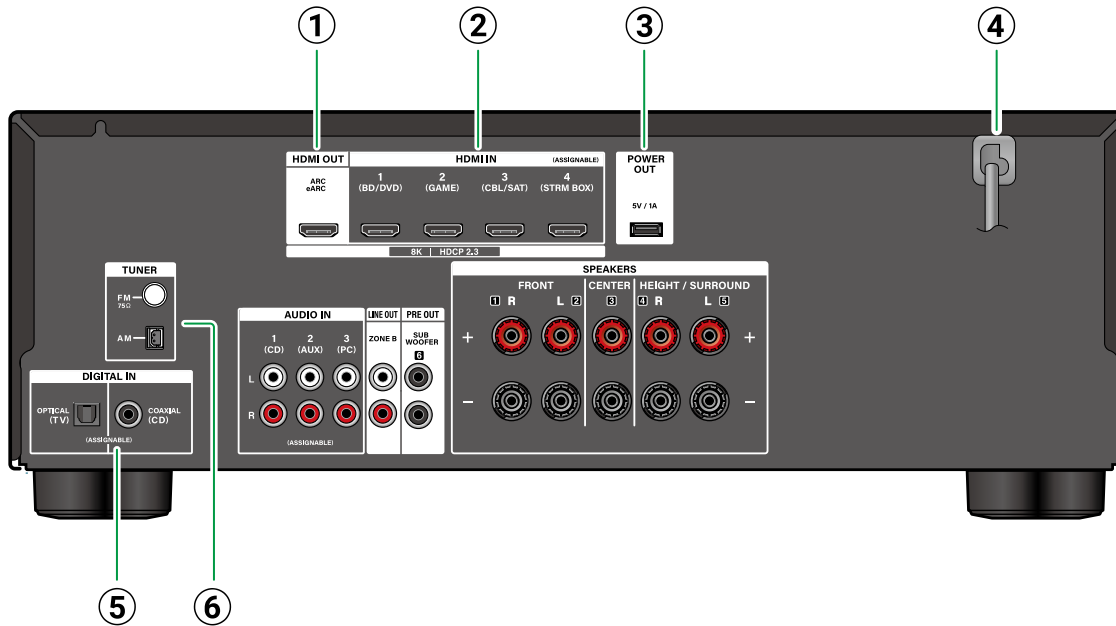

- ⑥ **TUNER AM/FM terminal** (North American, Taiwanese, Middle East, Australian and Asian models): Connect the supplied antennas.
- TUNER DAB/FM terminal** (European models) : Connect the supplied antennas.

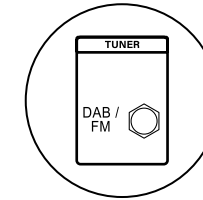

- ① **HDMI OUT jacks:** Transmit video signals and audio signals with an HDMI cable connected to a TV.
- ② **HDMI IN jacks:** Transmit video signals and audio signals with an HDMI cable connected to an AV component.
- ③ **POWER OUT port:** You can supply power (5 V/1 A) to the Streaming media player connected to the HDMI IN terminal of this unit with a USB cable ( → [p29](#)). The playback function of music files and power supply to smart phones/tablets, or other devices are not supported.
- ④ **Power cord**
- ⑤ **DIGITAL IN OPTICAL/COAXIAL jacks:** Input TV or AV component digital audio signals with a digital optical cable or digital coaxial cable.



# Rear Panel

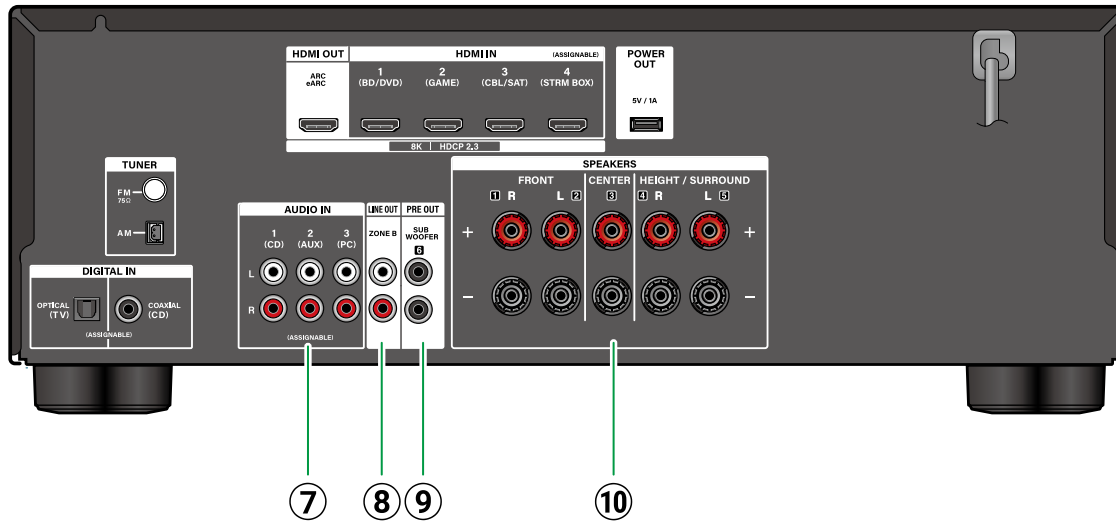

- ⑦ **AUDIO IN jacks:** Input AV component audio signals with an analog audio cable.
- ⑧ **ZONE B LINE OUT jacks:** Output audio signals with an analog audio cable connected to an Integrated Amplifier or transmitter in another place (ZONE B). (→p31)
- ⑨ **SUBWOOFER PRE OUT jacks:** Connect a powered subwoofer with a subwoofer cable.

- ⑩ **SPEAKERS terminals:** Connect speakers with speaker cables. (North American and Taiwanese models are banana plug ready. Use plugs with a diameter of 4 mm.) Y plug connection is not supported.



# Remote Controller

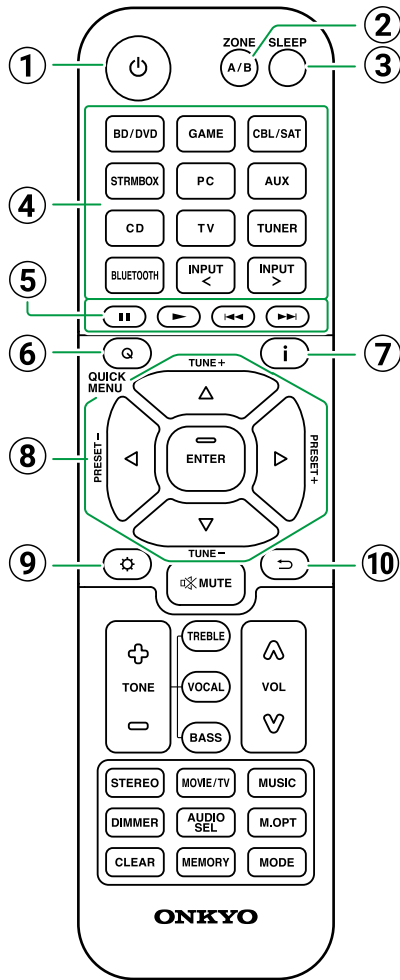

- ① **ON/STANDBY button**
- ② **ZONE A/B button:** Selects an audio output destination from among "ZONE A", "ZONE B" and "ZONE A+B". (→[p48](#))
- ③ **SLEEP button:** You can allow the unit to enter standby automatically when the specified time has elapsed. Select the time from "30 min", "60 min", "90 min" and "Off". When you do not want to turn the unit to standby automatically, select "Off". You can also set this by pressing **SETUP** button and selecting "Hardware" - "Power Management" - "Sleep Timer" (→[p71](#)) on the Setup menu.
- ④ **Input selector buttons:** Switches the input to be played.
- ⑤ **Play buttons:** Used for playback operation of a BLUETOOTH-enabled device. Also, switching to "CEC MODE" with ⑩ **MODE** button allows you to operate an HDMI CEC function-enabled AV component. (Some devices may not be operated.)
- ⑥ **Q QUICK MENU button:** Pressing this button during playback allows you to make settings such as "HDMI" and "Audio" quickly on the TV screen while playing. (→[p46](#))
- ⑦ **i INFORMATION button:** Switches the information on the display and is used to operate RDS (European, Middle East, Australian and Asian models) (→[p42](#)).
- ⑧ **Cursor ▲ / ▼ / ◀ / ▶ UP/DOWN/LEFT/RIGHT buttons and ENTER button:** Select an item with the cursors, and press ENTER to confirm your selection.
- ⑨ **SETUP button:** Displays advanced setting items on the TV or the display to have a more enjoyable experience with this unit. (→[p53](#))

- ⑩ **RETURN/EXIT button:** Returns the display to the previous state while setting.



# Remote Controller

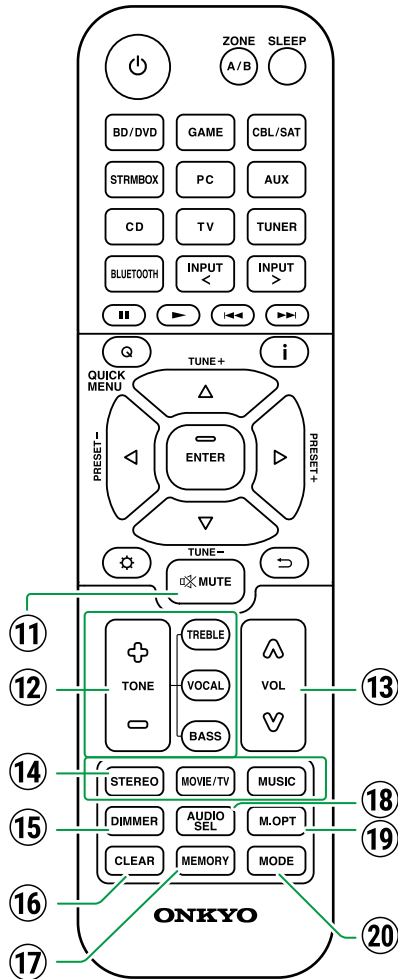

- ⑪ **MUTE button**: Temporarily mutes audio. Press the button again to cancel muting.
- ⑫ **TONE buttons**: Adjusts the sound quality. ([→p45](#))
- ⑬ **VOLUME buttons**
- ⑭ **LISTENING MODE buttons**: Selects a listening mode ([→p38, p91](#)).
- ⑮ **DIMMER button**: Switches the brightness of the display with three levels. It cannot be turned off completely.
- ⑯ **CLEAR button**: Deletes all characters you have entered when entering text on the TV screen.
- ⑰ **MEMORY button**: Used to register DAB (European models)/AM (North American, Taiwanese, Middle East, Australian and Asian models)/FM radio stations. ([→p44](#))
- ⑱ **AUDIO SEL button**: When a device is connected to two or more audio input terminals for one input selector, you can select which audio input signal to play.
- ⑲ **M.OPT button**: Turns on/off the Music Optimizer function that improves the quality of the compressed audio. ([→p46](#))
- ⑳ **MODE button**: Switches between automatic tuning and manual tuning ([→p40](#)) for AM (North American, Taiwanese, Middle East, Australian and Asian models)/FM stations, and allows you to select the order for displaying DAB (European models) stations ([→p43](#)). Also, when an HDMI CEC function-enabled AV component is connected to this unit, you can switch ⑤ Play buttons between "CEC MODE" and "RCV MODE" (normal mode).



# Inputting Characters

You can input characters or symbols on the keyboard displayed on the TV screen such as when naming a preset radio station ( →p65).

1. Select a character or symbol with the cursors ▲ / ▼ / ◀ / ▶ UP/DOWN/LEFT/ RIGHT on the remote controller and press the ENTER button.
2. When saving characters after input, select "OK" and press the ENTER button.

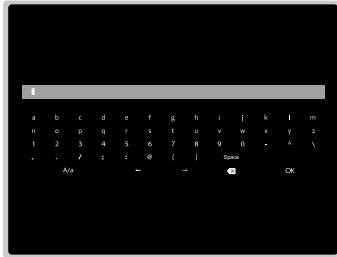

- Select "A/a" to switch between upper and lower cases. (Can also be switched with the MODE button on the remote controller.)
- To enter a space, select "Space".
- To delete a character on the left of the cursor, select "⌫".
- To delete all the input characters, press the CLEAR button on the remote control.

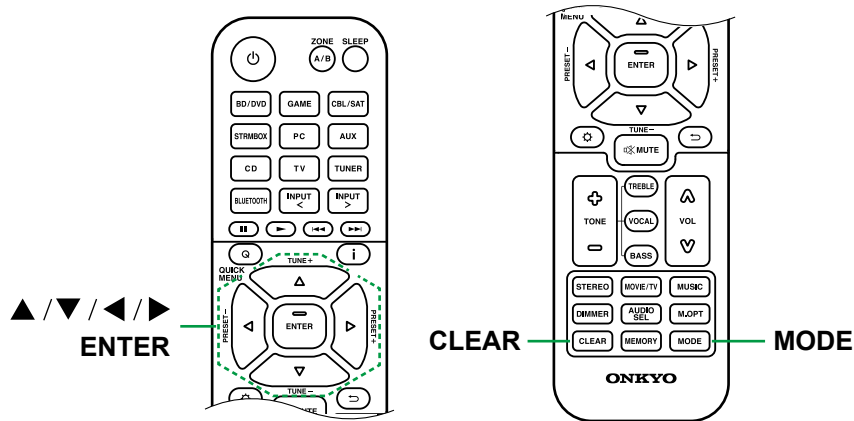

## Speaker Installation

### Setting Up the Speakers

How the speakers are set up depends on the size and shape of the room, so here we introduce just a basic layout example.

The alphabetic symbols used in this chapter represent the following speakers:

<b>FL</b>	Front speaker Left
<b>FR</b>	Front speaker Right
<b>C</b>	Center speaker
<b>SW</b>	powered SubWoofer
<b>SL</b>	Surround speaker Left
<b>SR</b>	Surround speaker Right
<b>FHL</b>	Front High speaker Left
<b>FHR</b>	Front High speaker Right
<b>TML</b>	Top Middle speaker Left
<b>TMR</b>	Top Middle speaker Right
<b>DFL</b>	Dolby enabled speaker Front Left
<b>DFR</b>	Dolby enabled speaker Front Right

**Speaker Connections** ( →[p19](#))

**Speaker Combinations** ( →[p99](#))



3.1ch

5.1ch

3.1.2ch



## 3.1 Channel System

A 3.1 Channel System that combines front speakers with a center speaker and a subwoofer.

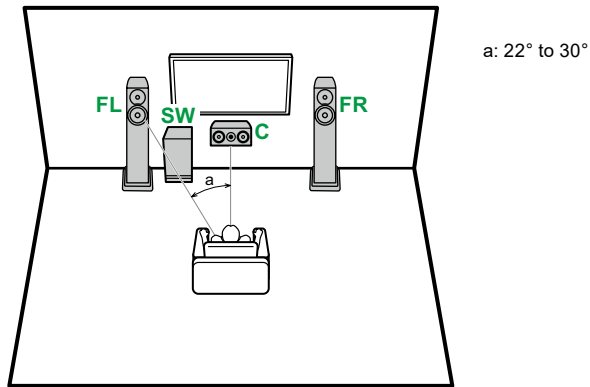

- FL, FR** Place the left and right front speakers to match ear height.
- C** The center speaker should be set up facing the listening position at an angle.
- SW** Place next to the Front Speakers.

## 5.1 Channel System

This is a basic 5.1 Channel System.

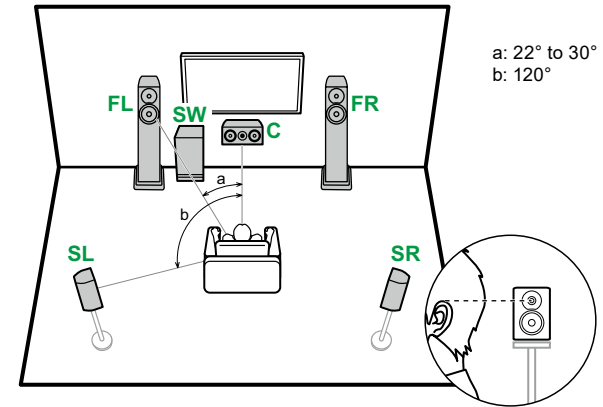

- FL, FR** Place the left and right front speakers to match ear height.
- C** The center speaker should be set up facing the listening position at an angle.
- SW** Place next to the Front Speakers.
- SL, SR** Place the left and right surround speakers to be just above ear height.

3.1 ch connection ( → [p22](#) )

5.1 ch connection ( → [p23](#) )



3.1ch

5.1ch

3.1.2ch

## 3.1.2 Channel System

### High Speakers

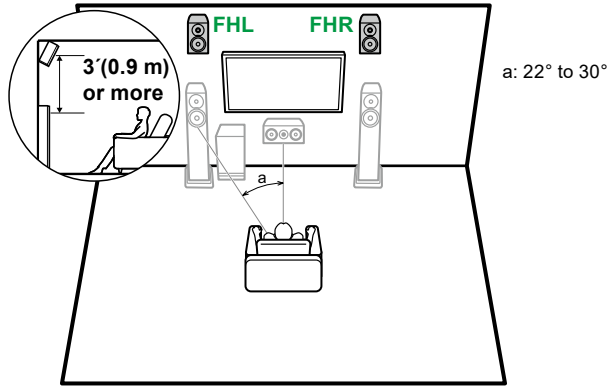

**FHL, FHR** Place the front high speakers directly above the front speakers, angled to face the listening position.

### Top Speakers

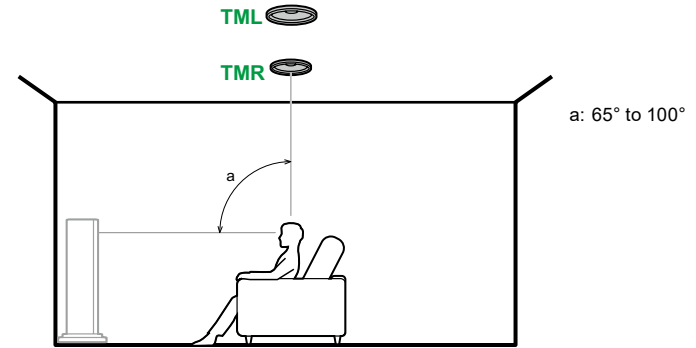

**TML, TMR** Fit top middle speakers on the ceiling directly above the listening position.

- Match the lateral distance of the top speakers to the front speakers.

### Dolby Enabled Speakers

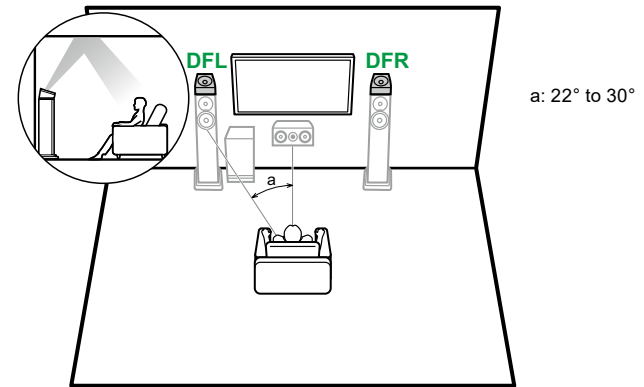

**DFL, DFR** The Dolby enabled speakers (front) are installed on top of the front speakers.

### 3.1.2 ch connection ( → [p24](#))



3.1ch

5.1ch

3.1.2ch

## Speaker Connections

**(Before starting the procedure)**  
**Speakers you can use with this unit and cable connections**

20

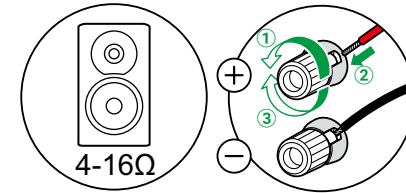

<b>Connecting the Subwoofer</b>	<b>21</b>
<b>3.1 Channel System</b>	<b>22</b>
<b>5.1 Channel System</b>	<b>23</b>
<b>3.1.2 Channel System</b>	<b>24</b>



3.1ch

5.1ch

3.1.2ch

## Speakers you can use with this unit and cable connections

### ■ Speakers you can use with this unit

This unit supports speakers with 4 Ω to 16 Ω impedance. For speaker impedance, check the speaker instruction manual.

### ■ (Note) Speaker Impedance

If any of the speakers to be connected has an impedance of 4 Ω or more and less than 6 Ω, set "Speaker Impedance" to "4ohms" for "Speaker Setup" in the Initial Setup section ( → [p74](#)). When setting "Speaker Impedance" from the Setup menu, press ⚙️ SETUP on the remote controller, and set "Speaker" - "Configuration" - "Speaker Impedance" ( → [p59](#)) to "4ohms".

### ■ Connect the Speaker Cables

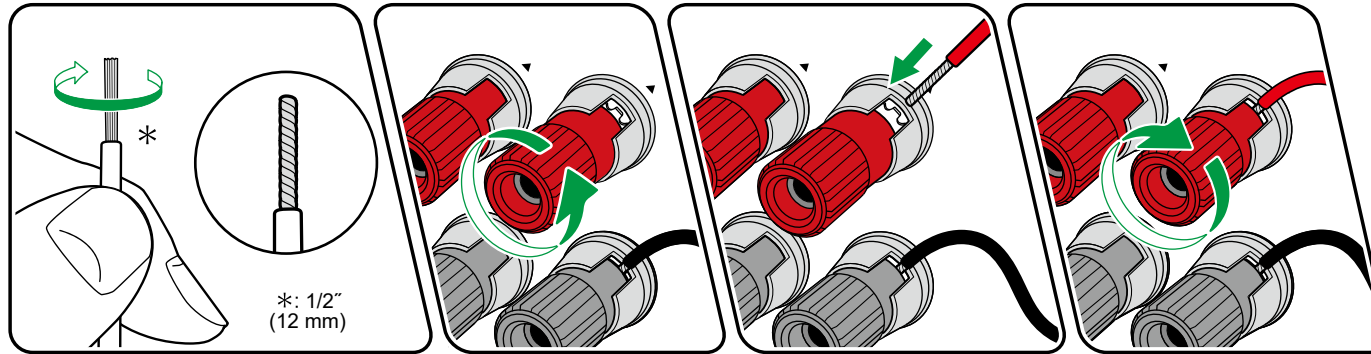

Make correct connection between the unit's jacks and speaker's jacks (+ side to + side, and - side to - side) for each channel. If the connection is wrong, a bass sound will not be reproduced properly due to reverse phase. Twist the wires exposed from the tip of the speaker cable so that the wires do not stick out of the speaker terminal when connecting. If the exposed wires touch the rear panel, or the + side and - side wires touch each other, a malfunction may occur.

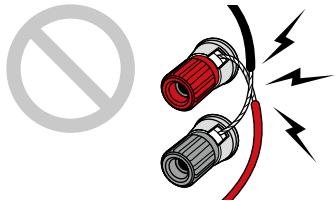

3.1ch

5.1ch

3.1.2ch

## Connecting the Subwoofer

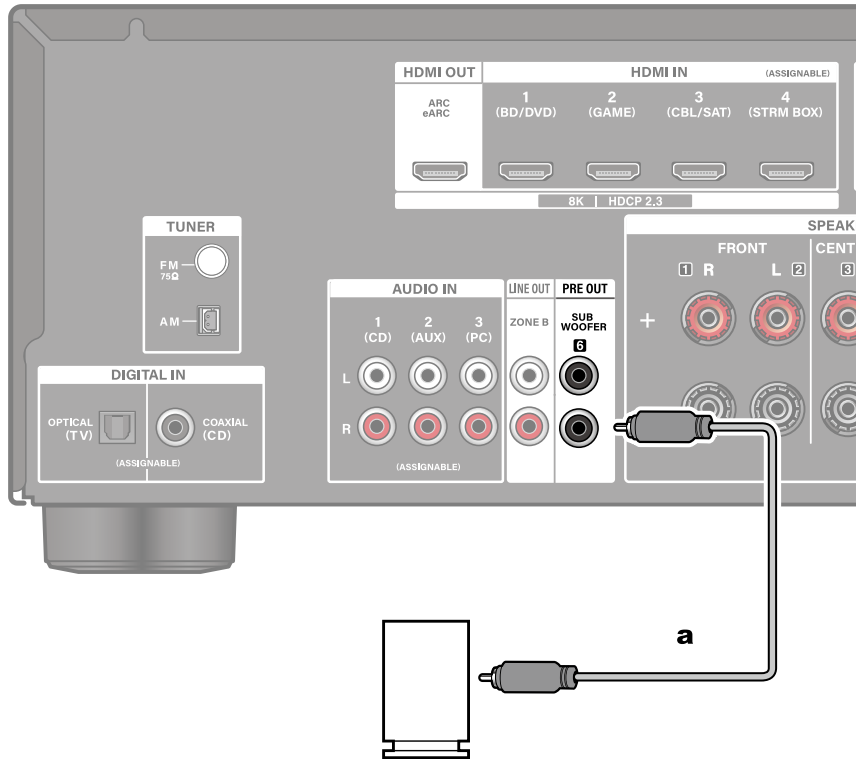

Connect a powered subwoofer with this unit using a subwoofer cable. Up to two powered subwoofers can be connected. The same signal is output from each SUBWOOFER PRE OUT jack.

**a** Subwoofer cable



3.1ch

5.1ch

3.1.2ch

## 3.1 Channel System

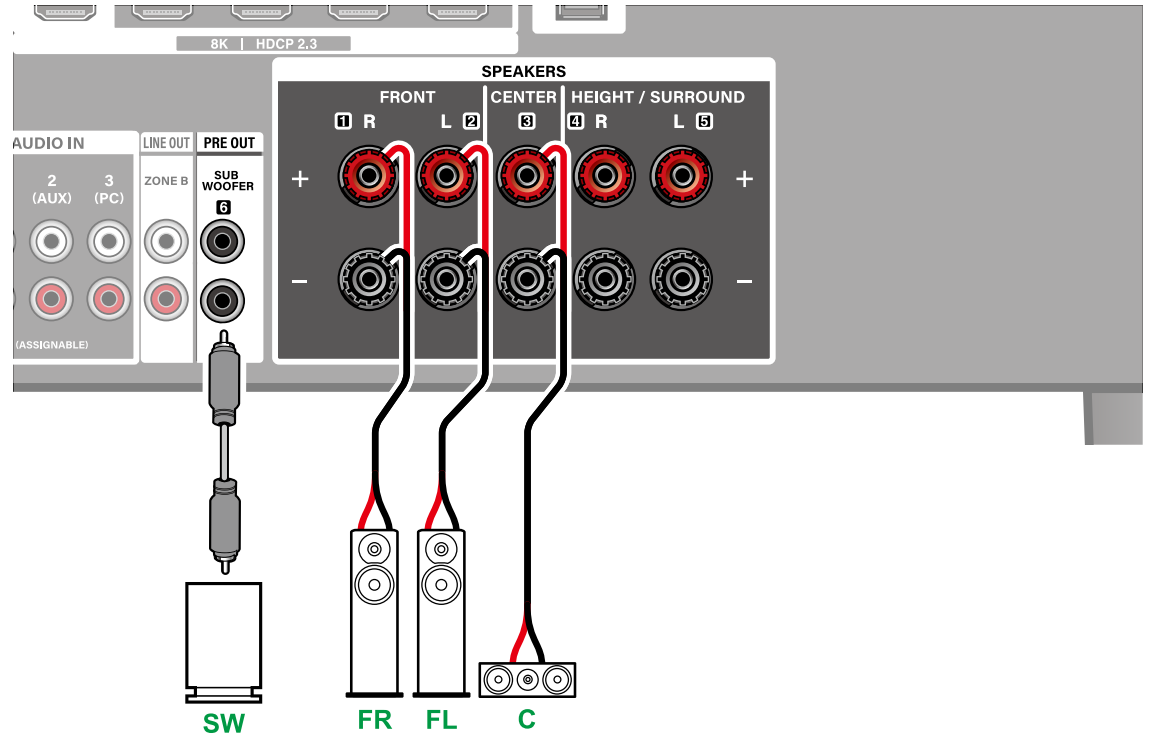
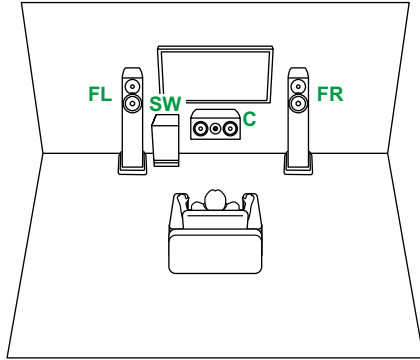

3.1ch

5.1ch

3.1.2ch



## 5.1 Channel System

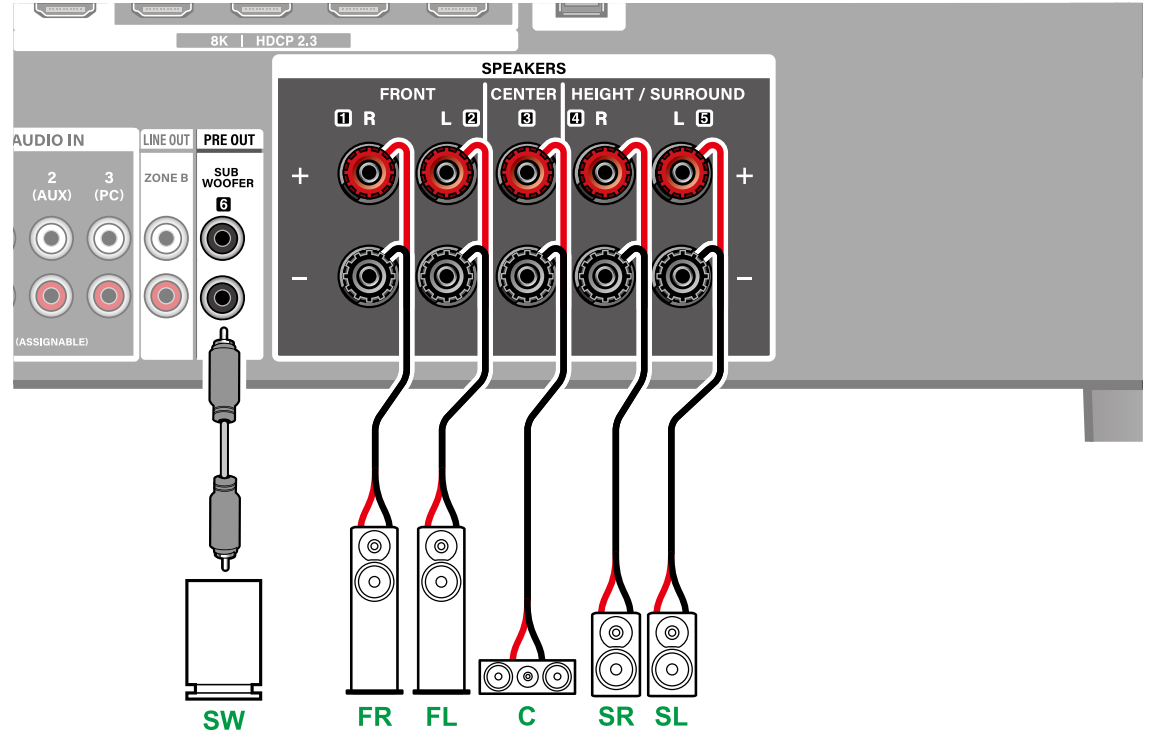
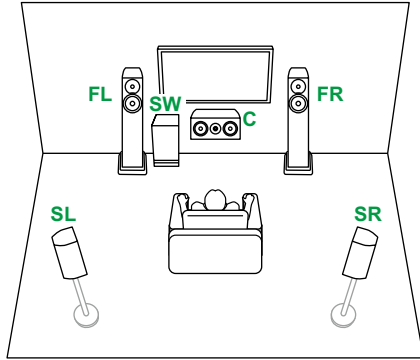

3.1ch

5.1ch

3.1.2ch



## 3.1.2 Channel System

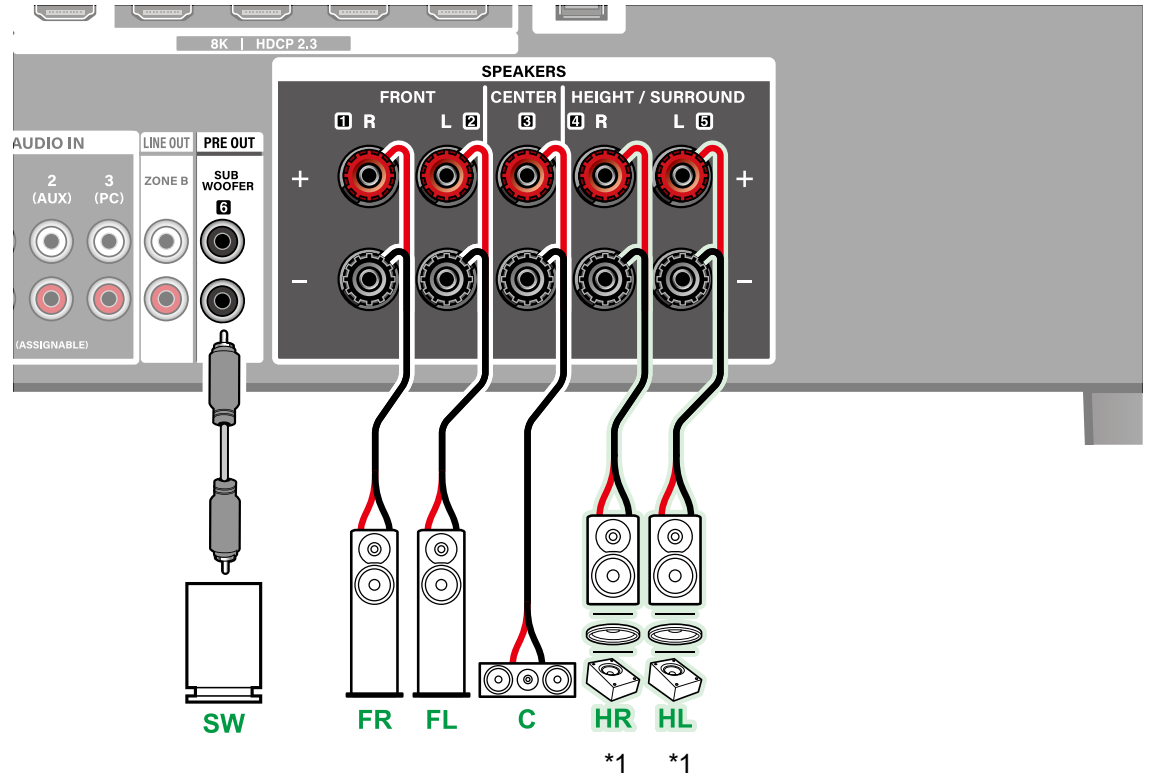
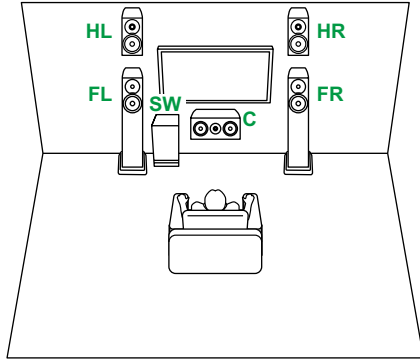

\*1 Connect the Height Speakers you have actually installed (HL/HR: Height Speakers, Top Speakers, Dolby Enabled Speakers).

3.1ch

5.1ch

3.1.2ch





<b>Notes regarding connections with HDMI cables</b>	<b>26</b>
<b>Connecting the TV</b>	<b>27</b>
<b>Connecting Playback Devices</b>	<b>29</b>
<b>Connecting an Integrated Amplifier or Transmitter (ZONE B)</b>	<b>31</b>
<b>Connecting Antennas</b>	<b>32</b>
<b>Connecting the Power Cord</b>	<b>33</b>

## Connections



## Notes regarding connections with HDMI cables

HDMI (High-Definition Multimedia Interface) is a digital interface standard for connecting TVs, projectors, Blu-ray Disc players, game consoles, and other video components. With HDMI, a single cable can carry control signals, digital video, and digital audio.

### Connections

Push HDMI cables straight in and all the way. You can damage the terminals if you try to insert at an angle.

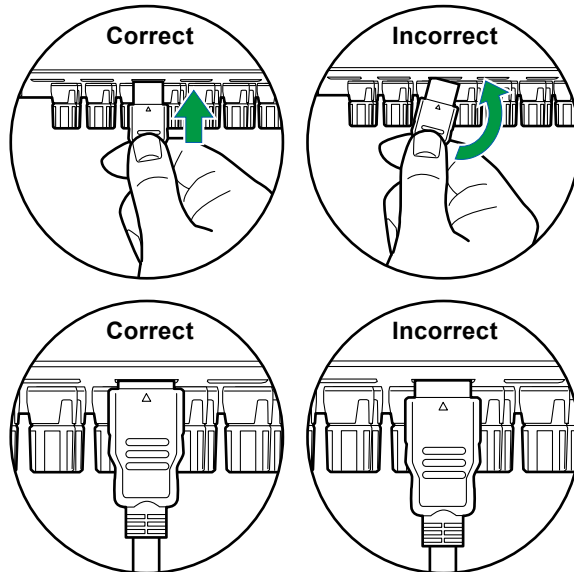

- Hold the terminal housing on the HDMI cable when unplugging. Pulling on the cable may lead to damaged cabling.

### ■ (Note) Placement of cables

Putting a load on HDMI cables can lead to poor operational performance. Place the cables so there is no load put on them.

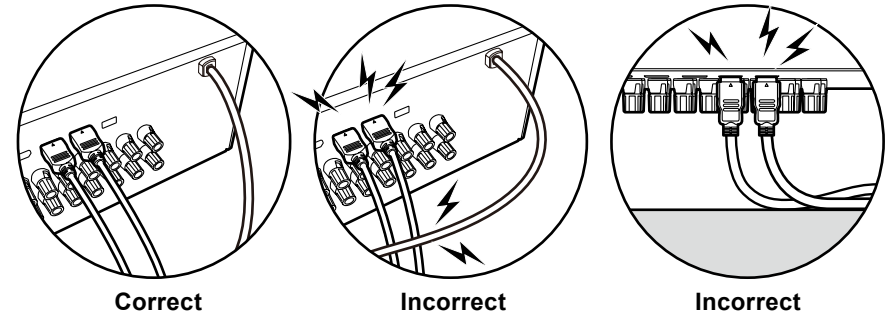

- When 4K high-quality video (4K 120 Hz, etc.) or 8K high-quality video (8K 60 Hz, etc.) is to be played, use ULTRA High Speed HDMI Cable that has the "ULTRA HIGH SPEED" label attached to the packaging.



## Connecting the TV

By connecting a TV to this unit, you can show the video from AV devices connected to this unit on the TV and also play the sound from the TV through this unit.

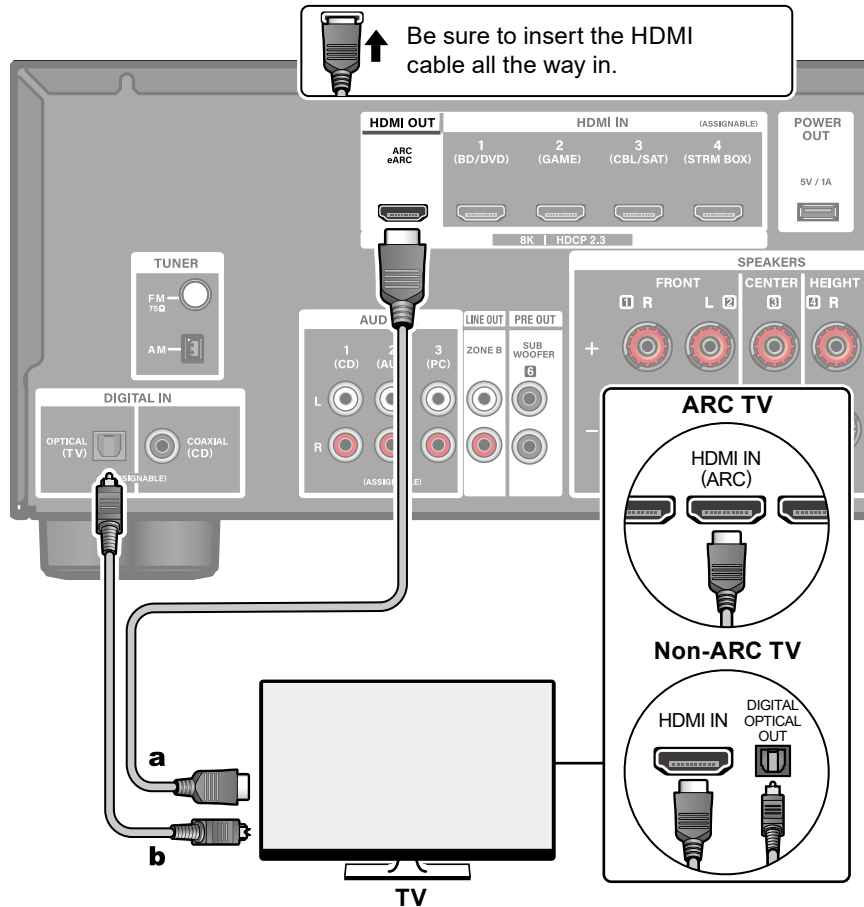

**a** HDMI cable, **b** Digital optical cable

### To ARC/eARC TV

If the TV supports the ARC (Audio Return Channel) function(\*), use only the HDMI cable to connect with the TV. Use the ARC-compatible HDMI IN jack of the TV for connection. You connect the HDMI cable to the HDMI OUT jack labeled "ARC" on the receiver side.

- When a TV compatible with the eARC function is connected, use an HDMI cable that supports Ethernet.

### To Non-ARC TV

If the TV does not support the ARC (Audio Return Channel) function(\*), connect an HDMI cable and digital optical cable. If the TV does not have a DIGITAL OPTICAL OUT jack, you can use an analog audio cable to connect with the AUDIO IN TV jack.

- If you use a cable set-top box, etc. connected to the input jack of this unit to watch TV (without using a TV's built-in tuner), connection with a digital optical cable or analog audio cable is not required.



#### Setup

- When not using the ARC function, press SETUP on the remote controller, then set "Hardware" - "HDMI" - "Audio Return Channel (eARC supported)" (→[p69](#)) to "Off".

(\*)The ARC function and eARC function transmit the audio signals of the TV via an HDMI cable, and plays the audio of the TV on this unit. To check if the TV supports the ARC function and eARC function, refer to the instruction manual of the TV, etc.

ARC/eARC compatible audio formats (→[p102](#))



- Settings are required when 8K high-quality video is to be played. Refer to "HDMI 4K/8K Signal Format" ( →[p55](#)) for information on the settings. Also, use an HDMI cable that supports 8K video.



## Connecting Playback Devices

### Connections to BD/DVD and GAME with HDMI jacks

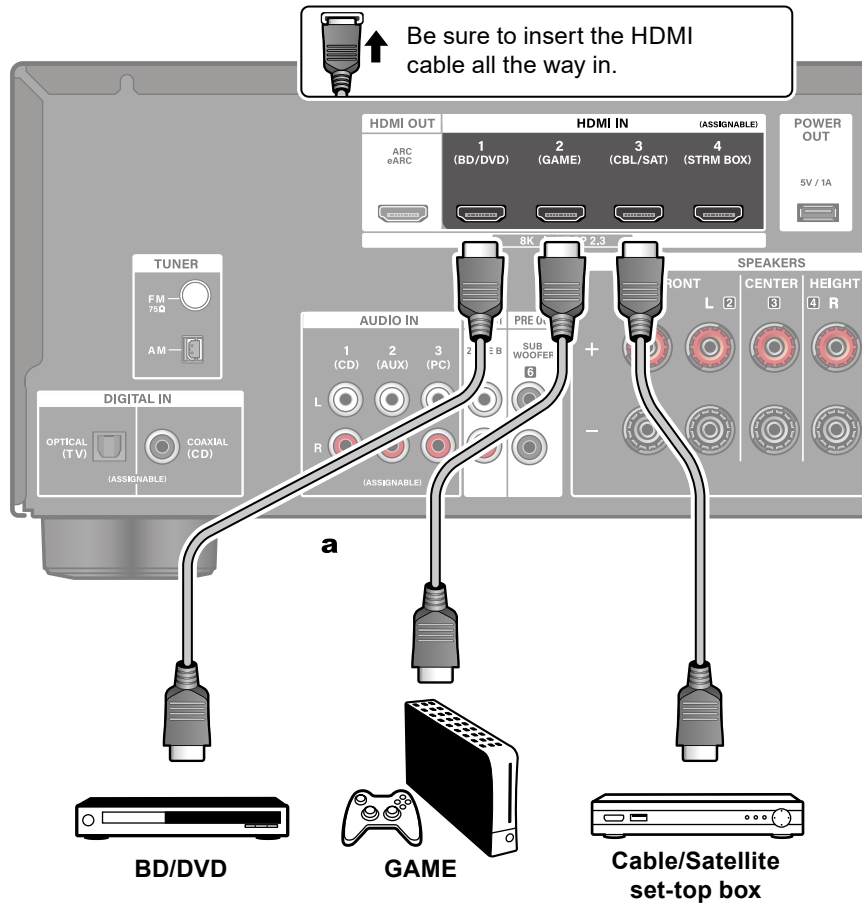

**a** HDMI cable

This is a connection example of an AV component equipped with an HDMI jack. When connecting with an AV component that conforms to the CEC (Consumer Electronics Control) standard, you can use the HDMI CEC function (\*) that enables linking with input selectors, etc. and the HDMI Standby Through function that can transmit video and audio signals of the AV component to the TV even if this unit is in standby mode.

- Settings are required when 8K high-quality video is to be played. Refer to "HDMI 4K/8K Signal Format" (→[p55](#)) for information on the settings. Also, use an HDMI cable that supports 8K video.
- The corresponding resolution is different depending on the HDMI jack connected. See "Corresponding input resolutions" (→[p103](#)) for details.

#### Note

- To enjoy digital surround sound including Dolby Digital, set the audio output of the connected Blu-ray Disc player etc. to the Bitstream output.
- (\*) The HDMI CEC function: This function enables various linking operations with CEC-compliant devices, such as switching input selectors interlocking with a CEC-compliant player, switching audio output between TV and this unit or adjusting the volume using the remote controller of a CEC-compliant TV, and automatically switching this unit to standby when the TV is turned off.



# Connecting an Audio Component

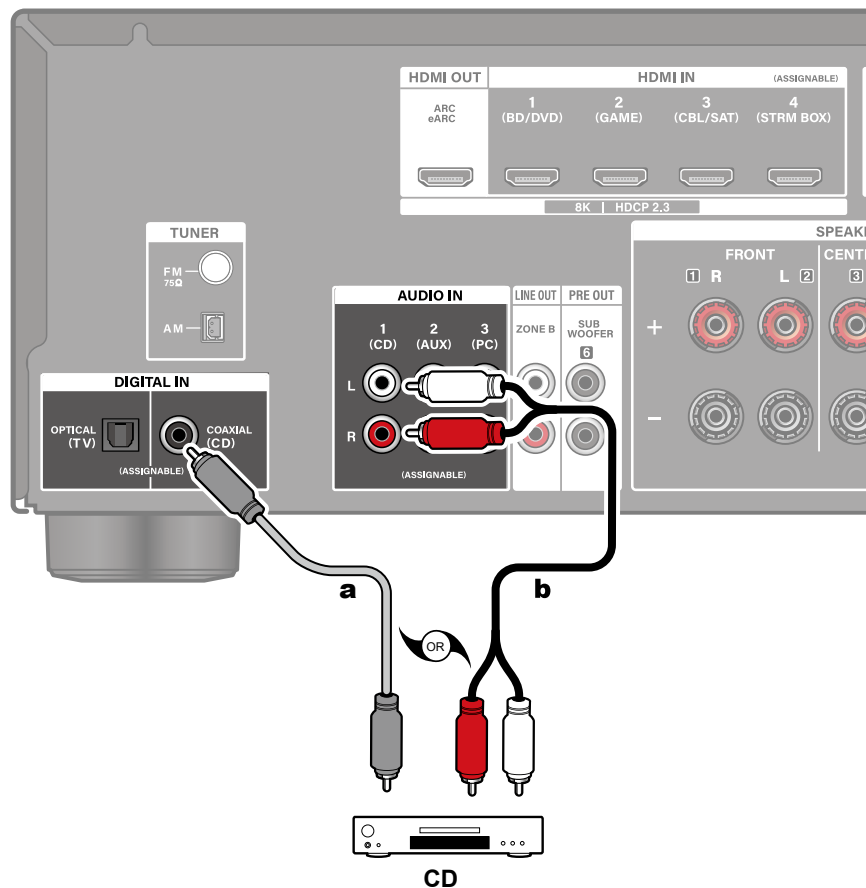

This is a connection example of an audio component. Connect a CD player using a digital coaxial cable or analog audio cable.

**a** Digital coaxial cable, **b** Analog audio cable



## Connecting an Integrated Amplifier or Transmitter (ZONE B)

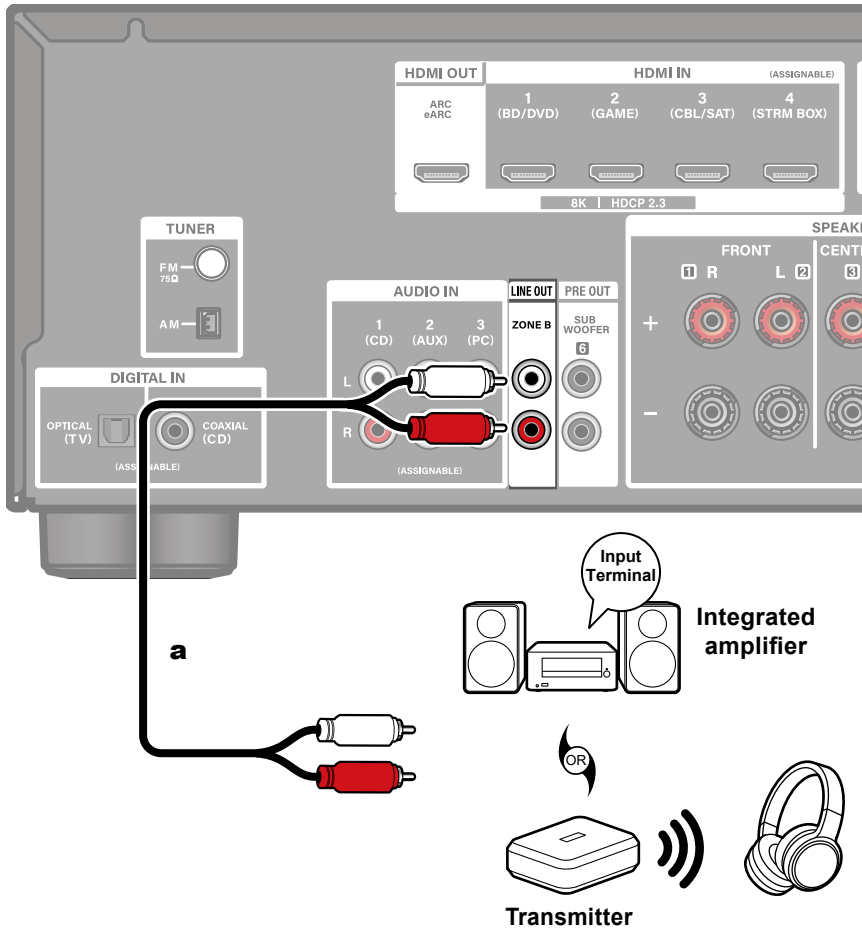

By connecting an Integrated Amplifier to the ZONE B LINE OUT terminal, you can play the same source in the other place (ZONE B) as in the main room. Also, when you connect a transmitter for wireless headphones or wireless speakers, you can play audio through these devices.

**a** Analog audio cable

**Playing Back (ZONE B)** ( → [p49](#))



# Connecting Antennas

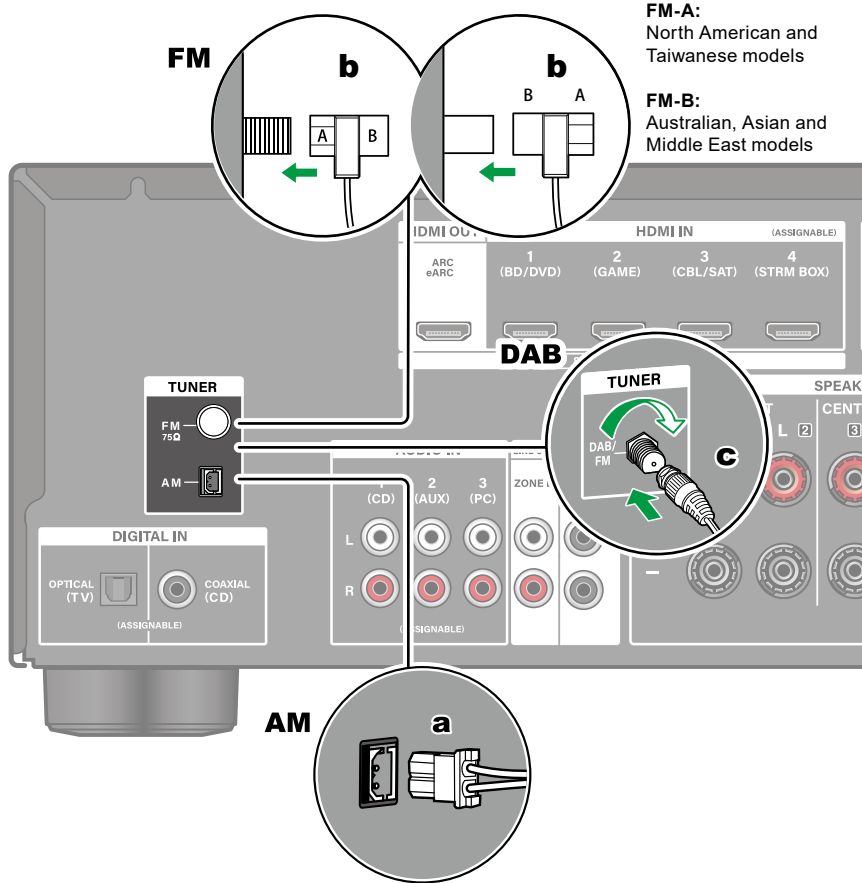

**FM-A:**  
North American and  
Taiwanese models

**FM-B:**  
Australian, Asian and  
Middle East models

## North American, Taiwanese, Middle East, Australian and Asian models

Connect the antenna to this unit, and set up the antenna at the best position for listening while receiving radio signals. Attach the indoor FM antenna to the wall using push pins or adhesive tape.

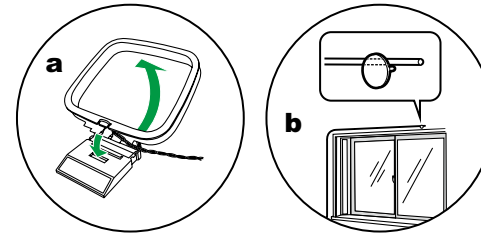

## European models

Make sure the plug is pushed in all the way, then fix in place by turning the nut to the right. Use a tack or similar to fix the antenna to a wall.

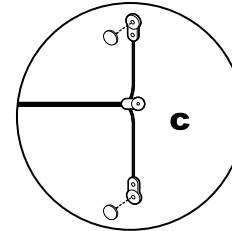

**a** AM loop antenna, **b** Indoor FM antenna, **c** DAB/FM antenna





# Connecting the Power Cord

Connect the power cord after all the connections are completed.

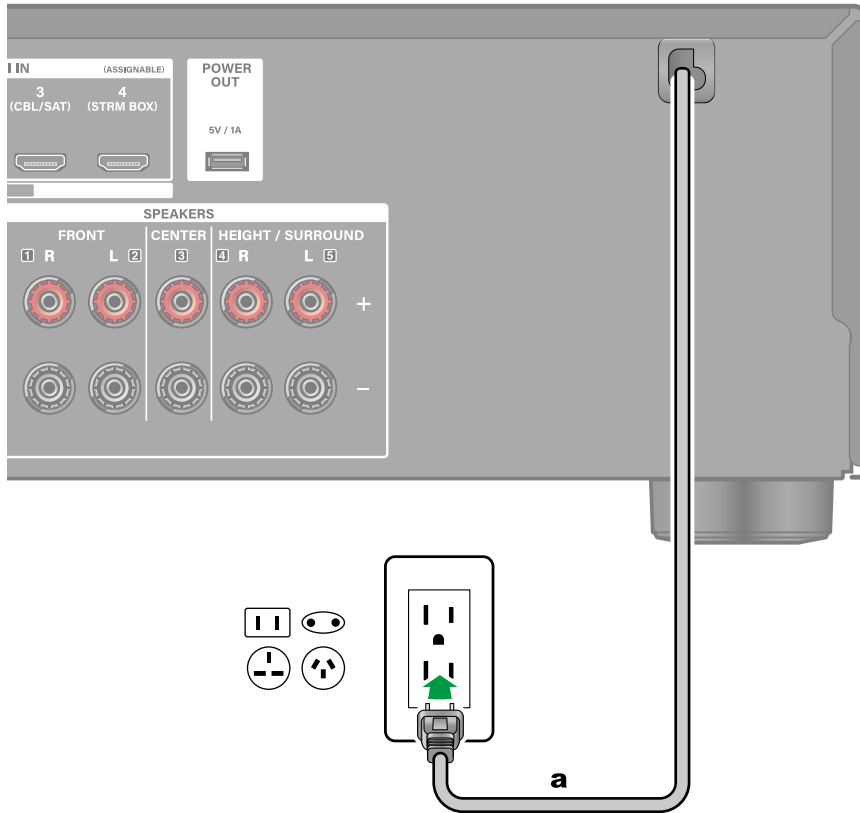

**a** Power cord



## Basic Operations

<b>Basic Operations</b>	<b>35</b>
<b>Listening Mode</b>	<b>38</b>
<b>BLUETOOTH® Playback</b>	<b>39</b>
<b>Listening To the Radio</b>	<b>40</b>
<b>Adjusting the tone</b>	<b>45</b>
<b>Quick Menu</b>	<b>46</b>

## Convenience functions

<b>ZONE B Playback</b>	<b>48</b>
<b>Playing different audio and video</b>	<b>50</b>

# Playback



## Basic Operations

### Turning the power on

1. Press  $\text{\textcircled{P}}$  ON/STANDBY on the remote controller to turn on the power of the unit.

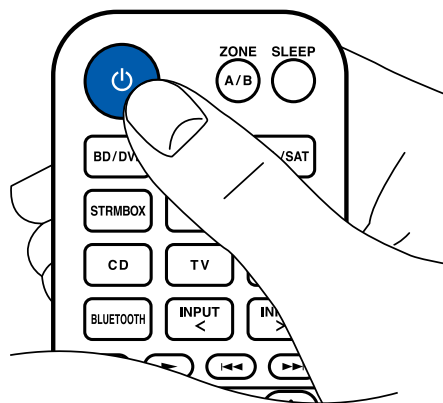

You can also turn on the power of the unit with the following operations:

- Pressing  $\text{\textcircled{P}}$  ON/STANDBY on the main unit.
- Using the linking function (HDMI CEC) (→ [p36](#))

### Selecting a source to play

1. Press an input selector button on the remote controller to select a source. For example, to play the device connected to the BD/DVD jack, press the BD/DVD button. To listen to the audio of the TV, press TV button.

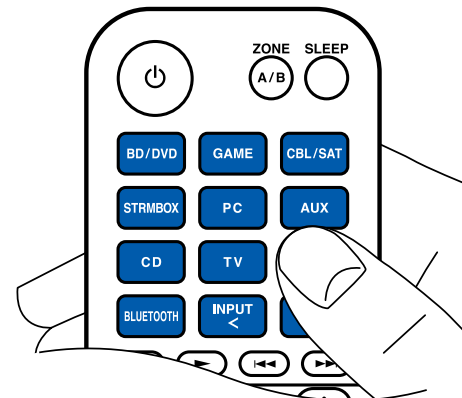

You can also select a source to play with the following operations:

- Pressing an input selector button on the main unit



## Adjusting the volume

1. Press the VOLUME buttons on the remote controller to adjust the volume. To temporarily turn off the sound, press the  MUTE button. Press again to cancel.
  - When Dolby Vision images are received, the volume bar on the TV screen changes from blue to magenta.

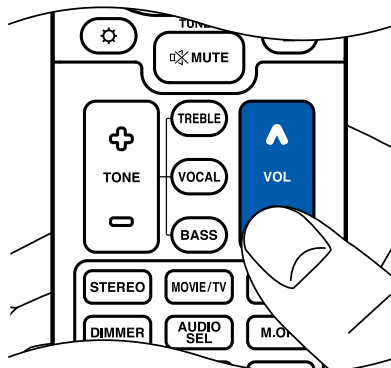

You can also adjust the volume with the following operations:

- Using the MASTER VOLUME on the main unit
- Using the linking function (HDMI CEC) ( → [p36](#) )

## Using the linking function (HDMI CEC)

By using a HDMI cable and connecting to a TV that is compatible with the HDMI CEC (Consumer Electronics Control) function, you are able to perform operations such as adjusting the volume of this unit with the TV's remote controller and link power On/Off. Furthermore, if you have connected a Blu-ray Disc player, GAME, etc. that is compatible with the HDMI CEC function, input switching is performed automatically.

- HDMI CEC settings ( → [p68](#) ) (the default value is On)
- For information about the HDMI CEC functions of the TV, refer to the operating instructions, etc., for the TV.
- The unit is designed to link with products that comply with the CEC standard, and that linked operation is not always guaranteed with all CEC devices.
- For linked functions to work properly, do not connect CEC-compliant devices exceeding the connectable number to the HDMI jack as shown below.
  - Blu-ray Disc/DVD players: up to 3 units
  - Blu-ray Disc/DVD recorders: up to 3 units
  - Cable TV tuner, terrestrial digital tuner, and satellite broadcasting tuner: up to 4 units



## Switching the display

Repeatedly pressing the **i** INFORMATION button on the remote controller switches the display of the main unit in the following order.

- The content displayed depends on the source, BLUETOOTH, etc., being played.
- Depending on the audio signal, "B (Back)" or "W (Wide)" is displayed next to the number of channels of the input format.
- Not all the information is necessarily displayed.

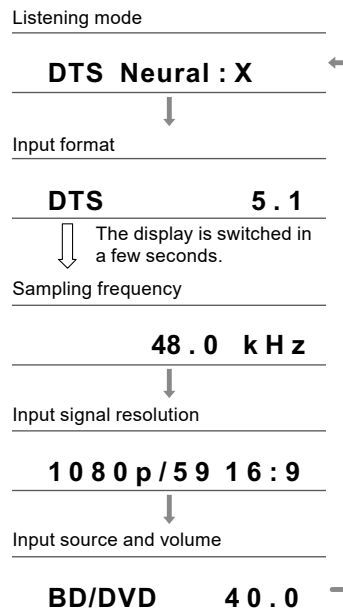

## Listening Mode

This unit is equipped with a variety of listening modes, and you can select the optimum listening mode for movies, TV, music, and games by pressing STEREO, MOVIE/TV and MUSIC. (→p91)

- For details of the effects of each listening mode, refer to "Listening Mode Effects" (→p95).
- For listening modes selectable for each audio format of input signals, refer to "Input Formats and Selectable Listening Modes" (→p92).

### Selecting a Listening mode

1. Press one from among STEREO, MOVIE/TV and MUSIC during playback.

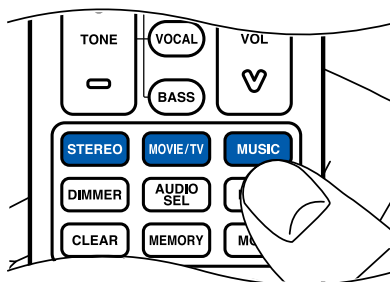

2. Press the selected button repeatedly to switch the modes displayed on the display of the main unit.

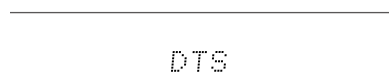

- Each of STEREO, MOVIE/TV and MUSIC buttons stores the listening mode that was selected last. If content incompatible of the listening mode selected last is played, the most standard listening mode for the content is automatically selected.

 Dolby Atmos

 DTS X

Manufactured under license from Dolby Laboratories. Dolby, Dolby Vision, Dolby Atmos, Dolby Audio, and the double-D symbol are trademarks of Dolby Laboratories.

For DTS patents, see <http://patents.dts.com>. Manufactured under license from DTS, Inc. or under license from DTS Licensing Limited. DTS, DTS:X, and Virtual:X logos are registered trademarks or trademarks of DTS, Inc. and its affiliates in the United States and other countries. © 2023 DTS, Inc. ALL RIGHTS RESERVED.



## BLUETOOTH® Playback

You can wirelessly play music on a smartphone or other BLUETOOTH wireless technology enabled device through the speakers connected to this unit.

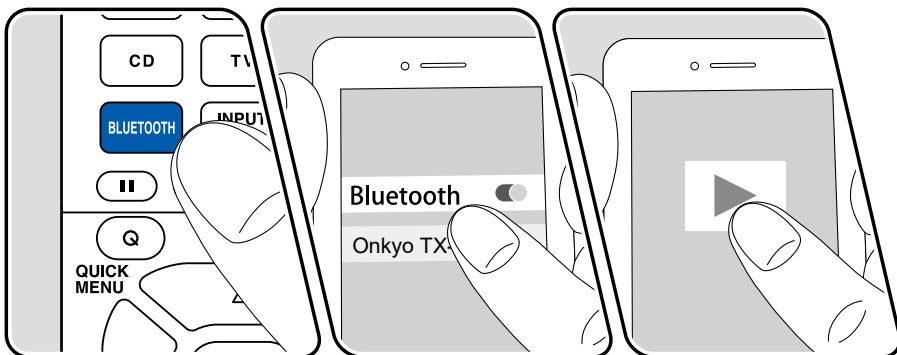
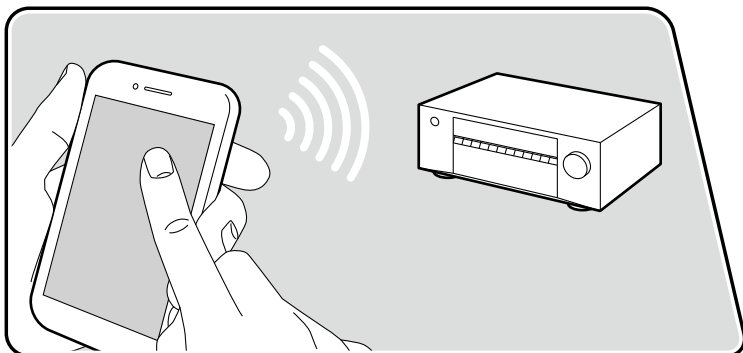

The illustration shows an image.

Perform the following procedure when this unit is on.

### Pairing

1. When you press the BLUETOOTH button, "Now Pairing..." appears on the display, and the pairing mode is enabled.

Now Pairing...

2. Enable (turn on) the BLUETOOTH function of the BLUETOOTH enabled device, and then select this unit from among the devices displayed. If a password is requested, enter "0000".
  - This unit is displayed as "Onkyo TX-SR3100 XXXXXX".
  - To connect another BLUETOOTH enabled device, press and hold the **i** INFORMATION button at least 5 seconds, and then perform step 2. This unit can store the pairing information of up to 8 paired devices.
  - The coverage area is approx. 48'/15 m. Note that connection is not always guaranteed with all BLUETOOTH enabled devices.

### Playing Back

1. Perform the connection procedure on the BLUETOOTH enabled device.
2. Playing the music file.

The input on this unit automatically switches to "BLUETOOTH".

Turn up the volume of the BLUETOOTH enabled device to an appropriate level.

- Due to the characteristics of BLUETOOTH wireless technology, the sound produced on this unit may slightly be behind the sound played on the BLUETOOTH enabled device.



## Listening To the Radio



You can receive AM (North American, Taiwanese, Middle East, Australian and Asian models)/FM/DAB (European models) radio on this unit with the built-in tuner.

### Listening To the AM/FM Radio (AM : North American, Taiwanese, Middle East, Australian and Asian models)

Perform the following procedure when this unit is on.

#### ■ Tuning Automatically

1. Press TUNER repeatedly to select either "AM" or "FM".
2. Press MODE repeatedly to display "TunMode: Auto" on the display.

TunMode: Auto

3. When you press the cursors ▲ / ▼ UP/DOWN, automatic tuning starts, and searching stops when a station is found. When tuned in to a radio station, the "TUNED" indicator on the display lights up. When tuned in to an FM radio station, the "FM ST" indicator lights up.

**When FM broadcasts reception is poor:** Perform the procedure for "Tuning Manually" (→p40). Note that if you tune manually, the reception for FM broadcasts will be monaural rather than stereo, irrespective of the sensitivity of the reception.

#### ■ Tuning Manually

Note that if you tune manually, the reception for FM broadcasts will be monaural rather than stereo, irrespective of the sensitivity of the reception.

1. Press TUNER repeatedly to select either "AM" or "FM".
2. Press MODE repeatedly to display "TunMode: Manual" on the display.

TunMode: Manual

3. While pressing the cursors ▲ / ▼ UP/DOWN, select the desired radio station.
  - Each time you press the cursors ▲ / ▼ UP/DOWN, the frequency changes by 1 step. If the button is held down, the frequency changes continuously, and if the button is released, the frequency stops changing.

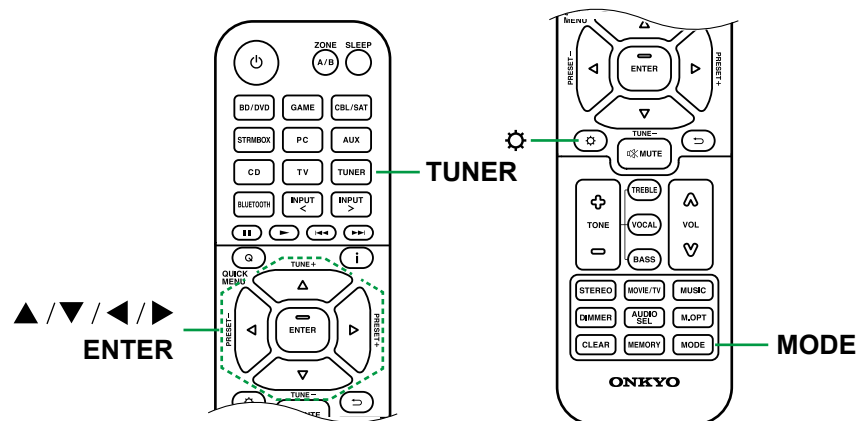



## ■ Frequency step setting (North American, Taiwanese, Middle East, Australian and Asian models)

Press  SETUP, and using the cursors and ENTER, select "Miscellaneous" - "Tuner" - "AM/FM Frequency Step" (North American and Taiwanese models) or "AM Frequency Step" (Middle East, Australian and Asian models), and then select the frequency step for your area. Note that when this setting is changed, all radio presets are deleted.



## □ Presetting a Radio Station ( → [p44](#))



## Using RDS (European, Middle East, Australian and Asian models)

RDS stands for Radio Data System, and is a method of transmitting data in FM radio signals. In regions where RDS can be used, when you tune in to a radio station broadcasting program information, the radio station name is displayed on the display. When you press the **i** INFORMATION button on the remote controller in this state, you can use the following functions.

### ■ Display Text Information (Radio Text)

1. While the name of the station is being displayed on the display, press the **i** INFORMATION button on the remote controller once.  
The Radio Text (RT), which is text information delivered by the station, is displayed scrolling across the display. "No Text Data" is displayed when no text information is delivered.

### ■ Search for Stations by Program Type

1. While the name of the station is being displayed on the display, press the **i** INFORMATION button on the remote controller twice.
  - If none of the Program Types are set for the radio station under reception, "None" is displayed.
2. Press the cursor buttons **◀/▶** LEFT/RIGHT on the remote controller to select the Program Type you want to search for, and then press the ENTER button to start the search.
  - The Program Types displayed are as follows: None / News (News reports) / Affairs (Current affairs) / Info (Information) / Sport / Educate (Education) / Drama / Culture / Science (Science and technology) / Varied / Pop M (Pop music) / Rock M (Rock music) / Easy M (Middle of the road music) / Light M (Light classics) / Classics (Serious classics) / Other M (Other music) / Weather / Finance / Children (Children's programmes) / Social (Social affairs) / Religion / Phone In / Travel / Leisure / Jazz (Jazz music) / Country (Country music) / Nation M (National music) / Oldies (Oldies music) / Folk M (Folk music) / Document (Documentary)
  - The information displayed may not match the content delivered by the station.

3. When a station is found, the station blinks on the display. Pressing the ENTER button in this state will receive that station. If you don't press the ENTER button, the unit starts to search for another station.
  - If no stations are found, the message "Not Found" is displayed.
  - Unusual characters may be displayed when the unit receives unsupported characters. This is not a malfunction. Also, if the signal from a station is weak, information may not be displayed.

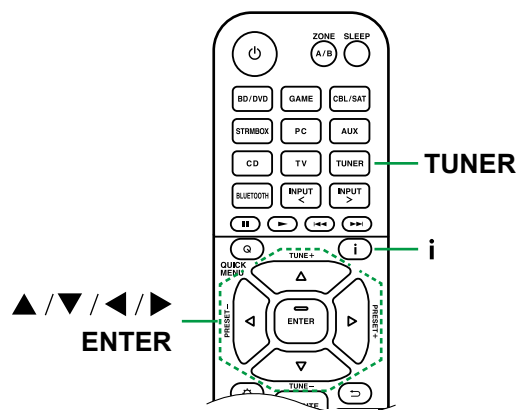

### □ Presetting a Radio Station ( →p44)



# Listening To DAB Digital Radio (European models only)

Perform the following procedure when this unit is on.

1. Press TUNER repeatedly to select "DAB".
  - The very first time you select DAB, the Auto Tuning function automatically scans the DAB Band 3 for the multiplexes (i.e., stations) available in your area. Once the scanning process is complete, the first station that was detected is selected.

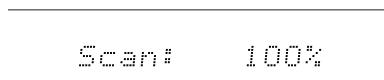

2. Select the desired radio station with ▲ / ▼ UP/DOWN.
  - If a new DAB station is introduced, or you move to a new area, press SETUP, then use the cursors and ENTER button to run the "DAB Auto Scan" in "Miscellaneous" - "Tuner".

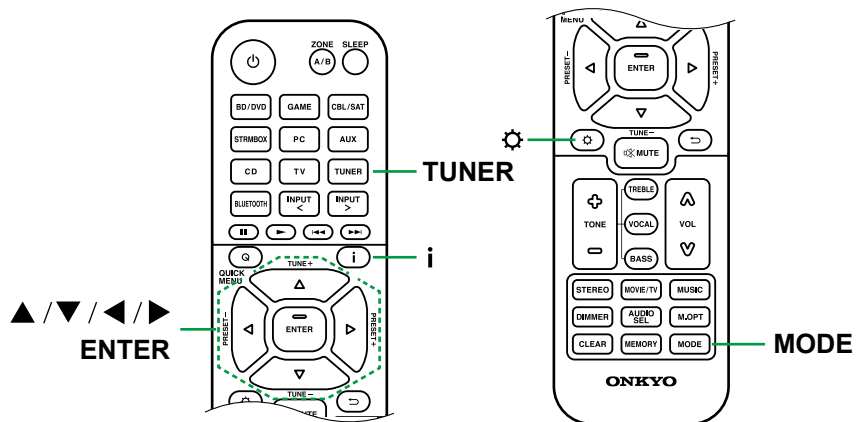

## ■ Changing the order stations are displayed

You can sort the available stations alphabetically or by multiplex.

1. Press MODE repeatedly to set the method for sorting the display order from the following.

**Alphabet** (default setting): Sort stations alphabetically.

**Multiplex**: Sort stations by multiplex.

## ■ Displaying DAB Radio Information

1. Press INFORMATION repeatedly to display more information about the selected DAB station.

**DLS** (Dynamic Label Segment): When tuned to a station that's broadcasting DLS text data, the text will scroll across the display.

**Program Type**: Displays the type of program.

**Bit Rate and Audio Mode**: Displays the station's bit rate and audio mode (Stereo, Mono).

**Quality**: Displays the signal quality.

0 - 59: Poor reception

60 - 79: Good reception

80 - 100: Excellent reception

**Multiplex Name**: Displays the name of the current multiplex.

**Multiplex Number and Frequency**: Displays the number and frequency of the current multiplex.

## □ Presetting a Radio Station ( → [p44](#))



## Presetting a Radio Station

### Registration Procedure

You can preset up to 40(\*) of your favorite radio stations.

- (\*) North American, Taiwanese, Middle East, Australian and Asian models: AM and FM stations  
 European models: FM and DAB stations

After tuning in to the radio station you want to register, perform the following procedure.

1. Press MEMORY so that the preset number on the display blinks.

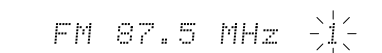

2. While the preset number is blinking (approx. 8 seconds), repeatedly press the cursors ◀/▶ LEFT/RIGHT to select a number between 1 and 40.
3. Press MEMORY again to register the station.  
 When the station is registered, the preset number stops flashing. Repeat this procedure for all of your favorite radio stations.

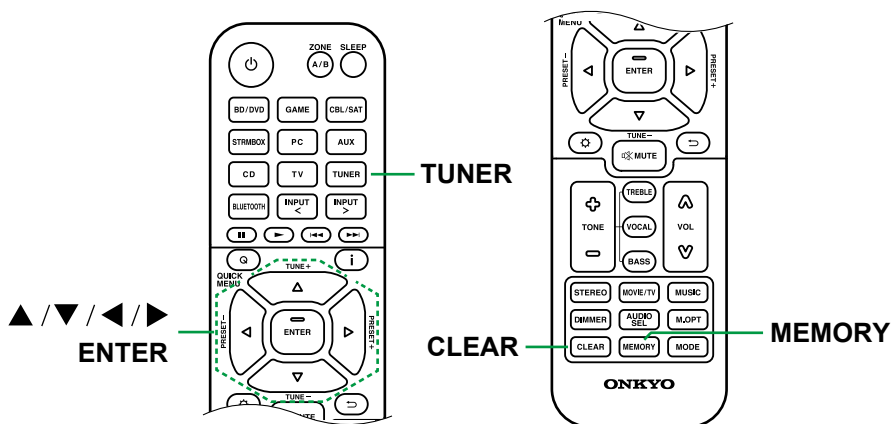

### Selecting a Preset Radio Station

1. Press TUNER.
2. Press the cursors ◀/▶ LEFT/RIGHT to select a preset number.

### Deleting a Preset Radio Station

1. Press TUNER.
2. Press the cursors ◀/▶ LEFT/RIGHT to select the preset number to delete.
3. After pressing MEMORY, press CLEAR while the preset number is blinking, and delete the preset number. When deleted, the number on the display disappears.



## Adjusting the tone

### Adjusting the TREBLE/BASS

You can adjust the sound quality of the front speakers.

1. Press TREBLE or BASS to select the content to adjust.  
TREBLE: Enhances or moderates the high-tone range of the front speakers.  
BASS: Enhances or moderates the low-tone range of the front speakers.
2. Press + or - to adjust.

### Adjusting the VOCAL

Emphasizes movie dialogues and music vocals to listen to them more easily. It is effective to movie lines in particular. Also, it exerts the effect even if the center speaker is not used. Select a desired level from "1" (low) to "5" (high).

1. Press VOCAL.
2. Press + or - to adjust.
  - Depending on the input source or listening mode setting, selection is not possible, or the desired effect may not be achieved.

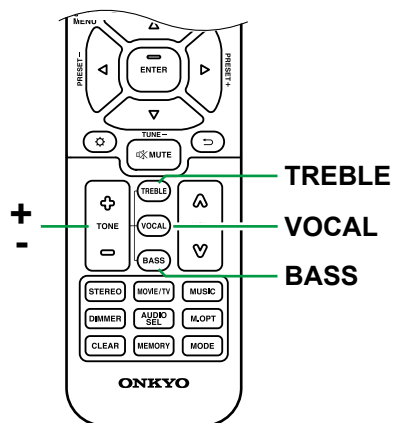

## Quick Menu

You can quickly set convenient features such as adjusting sound quality.

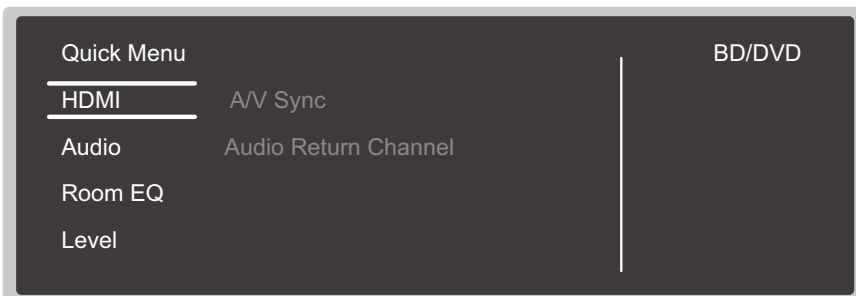

You can make the settings on the TV screen during playback. Press **Q** QUICK MENU on the remote controller to display the Quick Menu.

Select the item with the cursors **▲** / **▼** UP/DOWN of the remote controller, and press the ENTER button to confirm your selection.

Use the cursors to change the settings.

- To return to the previous screen, press **↩** RETURN/EXIT.
- To exit the settings, press **Q** QUICK MENU.

### Note

- When the input signals are ones that need a high bandwidth, such as 8K signals, the Quick Menu may not be displayed.

## HDMI

**A/V Sync:** If the video is behind the audio, you can delay the audio to offset the gap. The setting can be set for each input.

- It cannot be set if the listening mode is Direct.

**Audio Return Channel:** You can enjoy the sound of the HDMI-connected ARC-compatible TV through the speakers connected to the unit. Select "On" when listening to the audio of TV using the speakers of this unit. Select "Off" when the ARC function is not used.

## Audio

**Music Optimizer:** Improve the quality of the compressed audio. Playback sound of lossy compressed files such as MP3 will be improved. The setting can be set for each input. This works in signals whose sampling frequencies are 48 kHz or less. The setting is not effective in the bitstream signals.

- It cannot be set if the listening mode is Direct.

**Late Night:** Enable small sounds to be easily heard in detail. It is useful when you need to reduce the volume while watching a movie late night.

- This function cannot be used in the following cases.
  - When playing Dolby Digital Plus or Dolby TrueHD with "Loudness Management" set to "Off"
  - When the input signal is DTS:X, and "Dialog Control" is not 0 dB
  - When the input signal is Analog/DSD and the listening mode is Direct



**Stereo Assign:** This function enables you to select a pair of speakers to output stereo sound. Apart from the front speakers (Front), you can select the Surround speakers (Surround), Height speakers (Height).

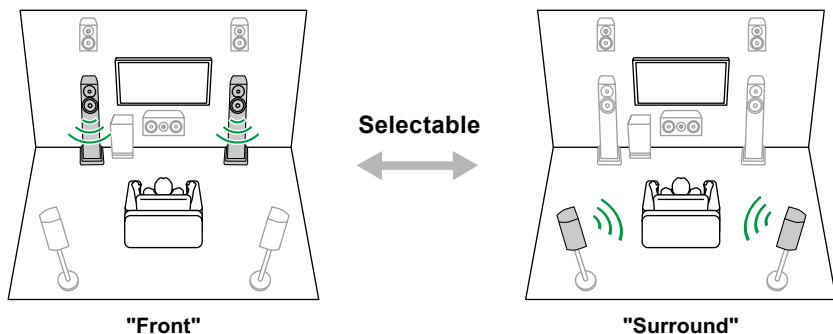

- The listening mode switches to "Stereo" if the audio output destination is changed.

**Digital Filter:** You can switch the type of digital filter in the AUDIO DAC (digital analog converter). You can choose "Slow" (gives the sound a soft and fluid feel), "Sharp" (gives the sound more structure and firmer feel), "Short" (gives the sound a feeling of a quick start and moving forward), or "Auto" (automatic). The setting can be separately set to each input selector. This can be set when the sampling frequency is 44.1 kHz or more.

## Room EQ

**AccuEQ:** Enable or disable the equalizer function that corrects for sound distortion caused by the acoustic environment of the room.

On (All Ch): EQ that corrects according to the room acoustics acquired with the AccuEQ calibration is applied to all channels.

On (ex. L/R): The same EQ as "On (All Ch)" is applied to speakers other than the Front Speakers. EQ correction for the Front Speakers is turned off.

- The setting can be separately set to each input selector.
- It cannot be set if the listening mode is Direct.

**Cinema Filter:** Adjusts the soundtrack with the enhanced high range so that it suits a home theater.

The following listening modes can be used: Dolby Audio - DD, Dolby Audio - DD+, Dolby Audio - Surr, Dolby Audio - TrueHD, Multichannel, DTS, DTS-HD, DTS Neural:X and DSD

## Level

**Front:** Adjust the speaker level of the front speakers while listening to the sound.

**Center:** Adjust the speaker level of the center speaker while listening to the sound.

**Subwoofer:** Adjust the speaker level of the subwoofer while listening to the sound.

- If you set the unit to the standby mode, the adjustments you made will be restored to the previous statuses.



## ZONE B Playback

While performing playback in the main room (ZONE A), you can enjoy the audio of the same source in the other place (ZONE B) at the same time.

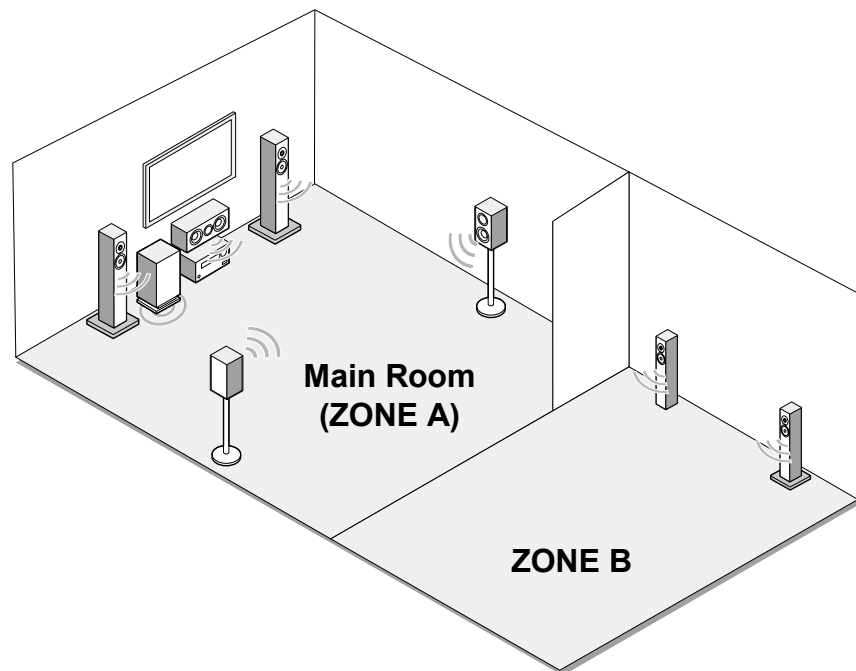

## Connections

When connecting an Integrated Amplifier or transmitter in the other place (ZONE B) to the ZONE B LINE OUT terminal on this unit.

– "Connecting an Integrated Amplifier or Transmitter (ZONE B)" ( →[p31](#))

**Playing Back** ( →[p49](#))





## Playing Back

1. Press ZONE A/B to select an audio output destination.
  - ZONE A: Outputs audio only to the main room (ZONE A). "A" on the display of the main unit lights up.
  - ZONE B: Outputs audio only to the other place (ZONE B). "B" on the display of the main unit lights up.
  - ZONE A+B: Outputs audio to both the main room (ZONE A) and the other place (ZONE B). "A" and "B" on the display of the main unit light up.

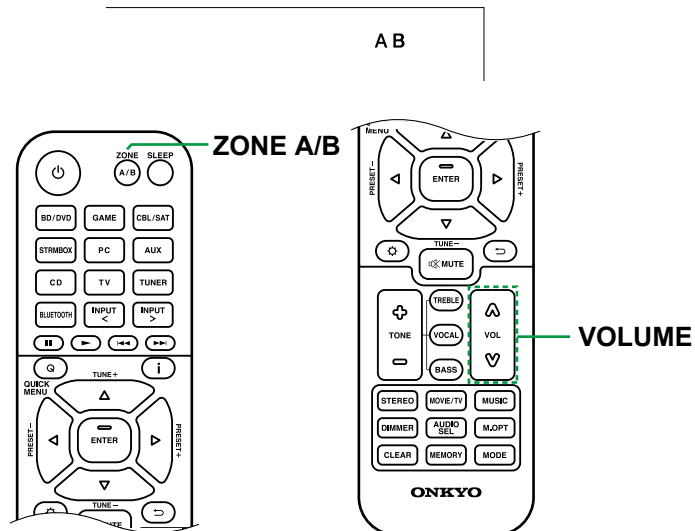

2. Start play on the AV component.
3. Adjust the volume on the integrated amplifier.
  - If the wireless headphones or wireless speakers have volume controls, control the volume on those devices.
  - If "ZONE A+B" is selected as an audio output destination, you can select only the "Stereo" listening mode for the main room (ZONE A) when using the 2.1ch speaker layout. When using a speaker layout of 3.1ch or more, you can select only the "AllCh Stereo" listening mode.



## Playing different audio and video

### Displaying Your Favorite Video on TV While Playing Music

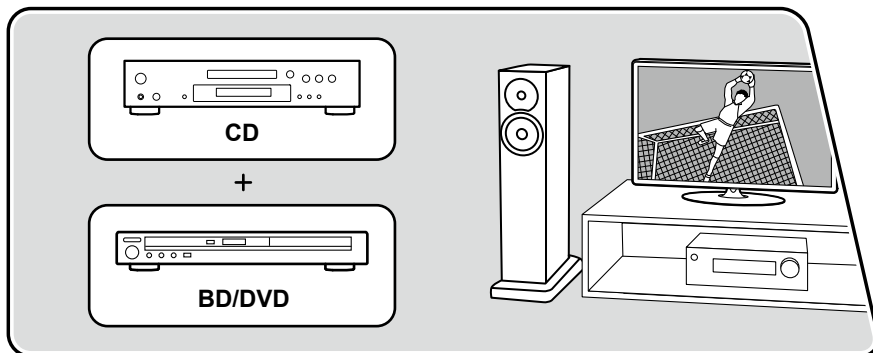

The illustration shows an image.

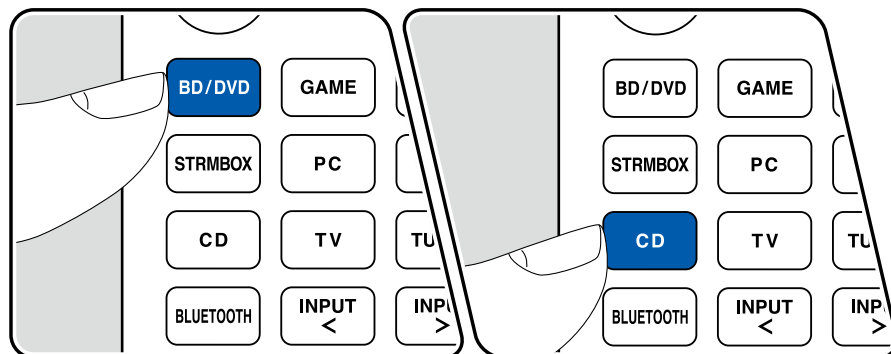

While listening to the music from a CD or BLUETOOTH enabled device, you can display video on TV from an AV component such as a Blu-ray Disc player.

- For audio playback, you can select an input selector to which video input is not assigned, such as "CD", "TUNER" and "BLUETOOTH".
- (European, Taiwanese, Middle East, Australian and Asian models): If the "OSD Language" ( →p56) is set to Chinese, it is not possible to play video while playing the audio from "BLUETOOTH".

Perform the following procedure when this unit is on.

1. Switch the input on the TV to the input connected to the unit.
2. Press an input selector such as BD/DVD button connected to the AV component of which the video is to be displayed on TV.
  - This operation is not necessary if the same input selector has been selected in the previous operation.
3. Press an input selector of the audio you want to play, such as the CD or BLUETOOTH button and perform playback operation.
4. Perform the playback operation of the AV component such as a Blu-ray Disc player. To play the audio of BLUETOOTH, the following step 5 operation is required.
5. To play the audio of BLUETOOTH, press the MODE button to switch the TV display from the BLUETOOTH playback screen to the video of the AV component. Pressing the MODE button again will return to the BLUETOOTH playback screen.
  - When the TV display is switched to the video of the AV component, the playback screen of BLUETOOTH is displayed on the corner of the screen as Mini Player. The setting for Mini Player can be changed on the Setup Menu so that it automatically turns off in 30 seconds after displayed. ("Mini Player OSD" ( →p56))



**Setting the video source to be displayed on TV beforehand:** When playing the audio of "TUNER" and "BLUETOOTH", you can set the input selector to be displayed on TV beforehand using "Video Select" (→[p67](#)) on the Setup Menu. If a value other than "Last" is set, step 2 in the operation procedure is not required.



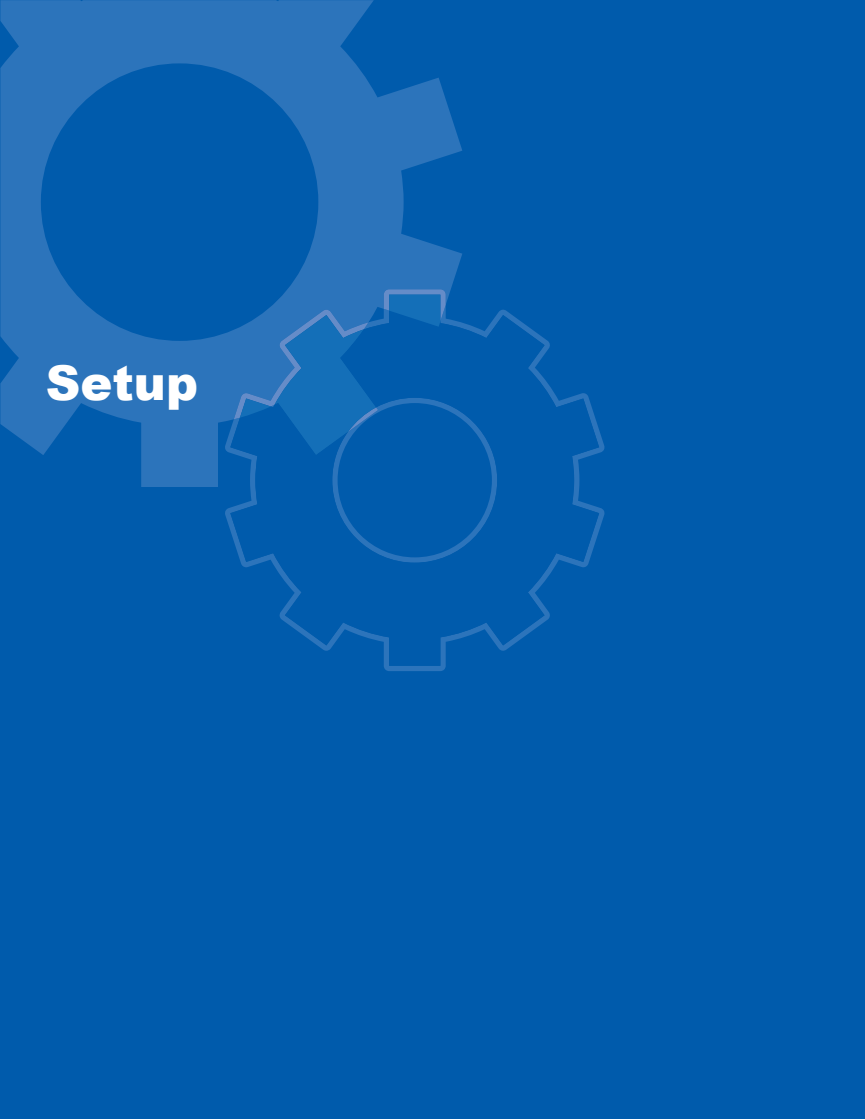



<b>Setup Menu</b>	<b>53</b>
<b>Initial Setup with Auto Start-up Wizard</b>	<b>74</b>





## Setup Menu

Use the OSD (On-Screen Displays) that appear on the TV to make the settings.

Press  SETUP on the remote controller to display the Setup menu.

Select the item with the cursors  /  UP/DOWN of the remote controller, and press the ENTER button to confirm your selection.

Use the cursors  /  LEFT/RIGHT to change the default values.

- To return to the previous screen, press  RETURN/EXIT.
- To exit the settings, press the  SETUP button.

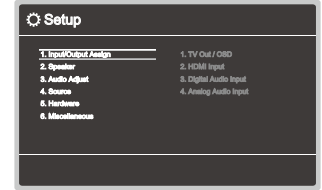

## Menu list

<b>1. Input/Output Assign</b>	<b>1. TV Out / OSD</b>	Make settings for TV output and On-Screen Displays (OSD) that appear on the TV.	<a href="#">p55</a>
	<b>2. HDMI Input</b>	You can change input assignment between the input selectors and HDMI IN jacks.	<a href="#">p57</a>
	<b>3. Digital Audio Input</b>	Change input assignment between the input selectors and DIGITAL IN COAXIAL/OPTICAL jacks.	<a href="#">p57</a>
	<b>4. Analog Audio Input</b>	Change input assignment between the input selectors and AUDIO IN jacks.	<a href="#">p58</a>
<b>2. Speaker</b>	<b>1. Configuration</b>	Change the settings of connection environment of the speakers.	<a href="#">p59</a>
	<b>2. Crossover</b>	Change the settings of crossover frequencies.	<a href="#">p60</a>
	<b>3. Distance</b>	Set the distance from each speaker to the listening position.	<a href="#">p61</a>
	<b>4. Level Calibration</b>	Adjust the volume level of each speaker.	<a href="#">p61</a>
	<b>5. Dolby Enabled Speaker</b>	Change the settings of Dolby Enabled Speakers.	<a href="#">p62</a>
	<b>6. Speaker Virtualizer</b>	The Speaker Virtualizer function can be switched between On and Off.	<a href="#">p62</a>
	<b>7. Speaker Combo</b>	You can optimize the crossover value to match Klipsch speakers.	<a href="#">p62</a>
<b>3. Audio Adjust</b>	<b>1. Multiplex/Mono</b>	Change the settings of multiplex audio playback.	<a href="#">p63</a>
	<b>2. Dolby</b>	Change the setting of when Dolby signals are input.	<a href="#">p63</a>
	<b>3. DTS</b>	Change the setting of when DTS signals are input.	<a href="#">p64</a>
	<b>4. LFE Level</b>	Set the low-frequency effect (LFE) level for Dolby Digital series, DTS series, Multichannel PCM, and DSD signals.	<a href="#">p64</a>
	<b>5. Volume</b>	Change the Volume settings.	<a href="#">p64</a>



<b>4. Source</b>	<b>1. My Input Volume</b>	Set a volume value for each input selector.	<a href="#">p65</a>
	<b>2. Name Edit</b>	Set an easy name for each input.	<a href="#">p65</a>
	<b>Audio Select</b>	Select the prioritized input terminal when multiple audio sources are connected to one input selector.	<a href="#">p66</a>
	<b>Video Select</b>	When "TUNER" or "BLUETOOTH" input is selected, you can set the input from which video is displayed on the TV.	<a href="#">p67</a>
<b>5. Hardware</b>	<b>1. HDMI</b>	Change the settings for the HDMI functions.	<a href="#">p68</a>
	<b>2. Bluetooth</b>	Change the settings for the BLUETOOTH function.	<a href="#">p70</a>
	<b>3. Power Management</b>	Change the settings for the power-save function.	<a href="#">p71</a>
<b>6. Miscellaneous</b>	<b>1. Tuner</b>	Change the settings for Tuner.	<a href="#">p72</a>
	<b>2. Firmware Update</b>	Change the settings for Firmware Update.	<a href="#">p73</a>
	<b>3. Initial Setup</b>	Make the initial setup from the setup menu.	<a href="#">p73</a>
	<b>4. Lock</b>	Lock the Setup menu so that the settings cannot be changed.	<a href="#">p73</a>
	<b>5. Factory Reset</b>	All the settings are restored to factory defaults.	<a href="#">p73</a>



# 1. Input/Output Assign

## 1. TV Out / OSD

Make settings for TV output and On-Screen Displays (OSD) that appear on the TV.

### □ Upscaling (Default Value: Off)

When a TV supporting 4K/8K is used, video signals input with 1080p can be automatically output with 4K/8K. Video signals that are input at 4K can also automatically be output as 8K. Note that to output as 8K, set "HDMI 4K/8K Signal Format" ( →p55) to "8K Standard" or "8K Enhanced", and you need to connect to a TV that is compatible with the 8K signal format with an HDMI cable.

- If the TV does not support the 4K/8K resolution with the same frequency as the frequency of HDMI input video signals, upscaling to 4K or 8K is not correctly performed. Check the frequency of 4K/8K resolution supported by the TV, and change the resolution of the video signals input from the AV component.

Off	When this function is not used • If your TV does not support 4K/8K, set it to "Off".
Auto	When this function is used

### □ Super Resolution (Default Value: 2)

When "Upscaling" is set to "Auto", select the correction level of the input video signals from "Off" and "1" (weak) to "3" (strong).

### □ HDMI 4K/8K Signal Format

Set the 4K/8K signal format input and output by this unit. Set to suit the TV or player connected.

- The corresponding resolution is different depending on the HDMI IN jack connected. See "Corresponding input resolutions" ( →p103) for details.

BD/DVD	(Default Value: 4K Enhanced)
GAME	(Default Value: 8K Enhanced)
CBL/SAT	(Default Value: 4K Enhanced)
STRM BOX	(Default Value: 4K Enhanced)
PC	(Default Value: 4K Enhanced)
CD	(Default Value: 4K Enhanced)
TV	(Default Value: 4K Enhanced)

4K Standard	When using a High Speed HDMI Cable that supports 10.2 Gbps to connect a TV or player compatible with standard 4K signal formats (4K 30 Hz, etc.)
4K Enhanced	When using a Premium High Speed HDMI Cable that supports 18 Gbps to connect a TV or player compatible with high-definition 4K signal formats (4K 60 Hz, 4K HDR, etc.) • There may be some image disruption depending on the connected component and the HDMI cable. If this occurs, switch to "4K Standard".
8K Standard	When using an ULTRA High Speed HDMI Cable that supports 48 Gbps to connect a TV or player compatible with 4K 120 Hz, 5K 30 Hz, or 8K 30 Hz signal formats
8K Enhanced	When using an ULTRA High Speed HDMI Cable that supports 48 Gbps to connect a TV or player compatible with 5K 60 Hz or 8K 60 Hz signal formats



# 1. Input/Output Assign

## ❑ OSD Language (Default Value: English)

Select the on-screen display language from the following.  
 (North American models)  
 English, German, French, Spanish, Italian, Dutch, Swedish  
 (European, Taiwanese, Middle East, Australian and Asian models)  
 English, German, French, Spanish, Italian, Dutch, Swedish, Russian, Chinese

## ❑ Impose OSD (Default Value: On)

Set whether or not to display information such as volume adjustment or switching of input on the TV screen.

On	OSD is displayed on the TV <ul style="list-style-type: none"> <li>OSD may not be displayed depending on the input signal even if "On" is selected. In this case, change the resolution of the connected device.</li> <li>When Dolby Vision signals are input, the volume bar changes from blue to magenta.</li> </ul>
Off	OSD is not displayed on the TV

## ❑ Mini Player OSD (Default Value: Always On)

You can display on the TV the images from another input selected last while playing the audio from BLUETOOTH input. After switching the input to BLUETOOTH, play the images and audio. And then when you press MODE on the remote controller, the image is displayed in full-screen mode, and the audio information (Mini Player) for BLUETOOTH is displayed in the corner of the screen. You can set whether to always display this Mini Player on the screen.

- Each time the MODE button is pressed, the image display/non-display can be switched.
- This setting cannot be selected if "Impose OSD" is set to "Off".
- This function cannot be used when "OSD Language" is set to Chinese. (European, Taiwanese, Middle East, Australian and Asian models)

Always On	The Mini Player is always displayed.
Auto Off	The Mini Player turns off automatically in 30 seconds after displayed. If operation such as changing the volume is performed, it is displayed again for 30 seconds.

## ❑ Screen Saver (Default Value: 3 minutes)

Set the time to start the screen saver.  
 Select a value from "3 minutes", "5 minutes", "10 minutes" and "Off".





# 1. Input/Output Assign

## ■ 2. HDMI Input

You can change input assignment between the input selectors and HDMI IN jacks.

- BD/DVD** (Default Value: HDMI 1 (HDCP 2.3))
- GAME** (Default Value: HDMI 2 (HDCP 2.3))
- CBL/SAT** (Default Value: HDMI 3 (HDCP 2.3))
- STRM BOX** (Default Value: HDMI 4 (HDCP 2.3))
- PC** (Default Value: ---)
- CD** (Default Value: ---)
- TV** (Default Value: ---)

"HDMI 1 (HDCP 2.3)" to "HDMI 4 (HDCP 2.3)":

Assign any HDMI IN jack to each of the input selectors. If you do not assign a jack, select "---". To select an HDMI IN jack already assigned to another input selector, change its setting to "---" first.

## ■ 3. Digital Audio Input

Change input assignment between the input selectors and DIGITAL IN COAXIAL/OPTICAL jacks. If you do not assign a jack, select "---".

- BD/DVD** (Default Value: ---)
- GAME** (Default Value: ---)
- CBL/SAT** (Default Value: ---)
- STRM BOX** (Default Value: ---)
- PC** (Default Value: ---)
- CD** (Default Value: COAXIAL)
- TV** (Default Value: OPTICAL)

COAXIAL, OPTICAL	Assign the COAXIAL terminal or OPTICAL terminal to any input selector.
---------------------	--



# 1. Input/Output Assign

## ■ 4. Analog Audio Input

Change input assignment between the input selectors and AUDIO IN jacks. If you do not assign a jack, select "---".

- **BD/DVD** (Default Value: ---)
- GAME** (Default Value: ---)
- CBL/SAT** (Default Value: ---)
- STRM BOX** (Default Value: ---)
- PC** (Default Value: AUDIO 3)
- AUX** (Default Value: AUDIO 2)
- CD** (Default Value: AUDIO 1)
- TV** (Default Value: ---)

AUDIO 1, AUDIO 2, AUDIO 3	Assign the AUDIO IN terminal to any input selector.
---------------------------------	---



## 2. Speaker

### ■ 1. Configuration

Change the settings of connection environment of the speakers.

#### □ Speaker Channels (Default Value: 5.1 ch)

Select "2.1 ch", "3.1 ch", "4.1 ch", "5.1 ch", "2.1.2 ch" or "3.1.2 ch" to suit the number of speaker channels connected.

#### □ Subwoofer (Default Value: Yes)

Set whether a powered subwoofer is connected or not.

No	When a powered subwoofer is not connected
Yes	When a subwoofer is connected

#### □ Height Speaker (Default Value: Top Middle)

Set the speaker type if height speakers are connected to the HEIGHT / SURROUND terminals.

Select "Top Middle", "Dolby Speaker (Front)" or "Front High" according to the type and layout of the connected speakers.

- If an item cannot be selected even though connection is correct, check that the settings in "Speaker Channels" matches the number of connected channels.

#### □ Speaker Impedance (Default Value: 6 ohms or above)

Set the impedance ( $\Omega$ ) of the connected speakers.

- For impedance, check the indications on the back of the speakers or their instruction manual.

4ohms	When any of the connected speakers have 4 $\Omega$ or more to less than 6 $\Omega$ impedance
6 ohms or above	When all the connected speakers have an impedance of 6 $\Omega$ or more



## 2. Speaker

### ■ 2. Crossover

Set what number of Hz in the low frequency range is output from each speaker and what should be output from the subwoofer. When a subwoofer is not to be used, set to "Full Band" so that the bass is output from the speakers.

#### □ Crossover Type (Default Value: Normal)

Set the crossover frequency to suit the speakers.

Klipsch	When Klipsch speakers are used. The crossover that is optimum for the speakers selected in Speaker Combo (→p62) is applied. In this case, the crossover for each speaker cannot be changed.
Normal	When other than Klipsch speakers are used

Front	(Default Value: 100 Hz)
Center	(Default Value: 100 Hz)
Height	(Default Value: 100 Hz)
Surround	(Default Value: 100 Hz)
LPF of LFE	(Default Value: 120 Hz)
Double Bass	(Default Value: On)

#### Front:

Select the crossover frequency from "40 Hz" to "200 Hz" to start outputting frequencies for each channel.

"Full Band": Full band will be output.

- If "Configuration" - "Subwoofer" is set to "No", "Front" is fixed to "Full Band", and the low pitched range of the other channels is output from the front speakers. Refer to the instruction manual of your speakers to make the setting.

#### Center, Height, Surround:

Select the crossover frequency from "40 Hz" to "200 Hz" to start outputting frequencies for each channel.

"Full Band": Full band will be output.

- "Full Band" can be selected only when "Front" is set to "Full Band".
- If the item cannot be selected even though connection is correct, check if the setting in "Configuration" - "Speaker Channels" matches the number of connected channels.

#### LPF of LFE:

Set the low-pass filter for LFE (low-frequency effect) signals in order to pass only the lower frequency signals than the set value, and thus cancel unwanted noises. The low-pass filter is effective only on sources with LFE channel.

The value from "80 Hz" to "120 Hz" can be set.

"Off": When this function is not used

#### Double Bass:

This can only be selected when the setting for "Configuration" - "Subwoofer" is "Yes", and the "Front" setting is "Full Band".

Boost bass output by feeding bass sounds from the front left and right speakers and the center speaker to the subwoofer.

"On": Bass output is boosted.

"Off": Bass output is not boosted.

- This function is not automatically set even if AccuEQ Room Calibration is performed.



## 2. Speaker

### ■ 3. Distance

Set the distance from each speaker to the listening position.

- Front Left** (Default Value: 12.0 ft/3.60 m)
- Center** (Default Value: 12.0 ft/3.60 m)
- Front Right** (Default Value: 12.0 ft/3.60 m)
- Height Left** (Default Value: 9.0 ft/2.70 m)
- Height Right** (Default Value: 9.0 ft/2.70 m)
- Surround Right** (Default Value: 7.0 ft/2.10 m)
- Surround Left** (Default Value: 7.0 ft/2.10 m)
- Subwoofer** (Default Value: 12.0 ft/3.60 m)

- Default values vary depending on the regions.
- The unit of distance can be changed by pressing the MODE button on the remote controller. When the unit is set as feet, you can set between 0.1 ft and 30.0 ft in increments of 0.1 ft. When the unit is set as meters, you can set between 0.03 m and 9.00 m in increments of 0.03 m.

### ■ 4. Level Calibration

Adjust the volume level of each speaker.

- Front Left** (Default Value: 0.0 dB)
- Center** (Default Value: 0.0 dB)
- Front Right** (Default Value: 0.0 dB)
- Height Left** (Default Value: 0.0 dB)
- Height Right** (Default Value: 0.0 dB)
- Surround Right** (Default Value: 0.0 dB)
- Surround Left** (Default Value: 0.0 dB)
- Subwoofer** (Default Value: 0.0 dB)

---

Select a value between "-12.0 dB" and "+12.0 dB" ("-15.0 dB" and "+12.0 dB" for Subwoofer) (in 0.5 dB increments). A test tone will be output each time you change the value. Select the desired level.

---



## 2. Speaker

### ■ 5. Dolby Enabled Speaker

Change the settings of Dolby Enabled Speakers.

- This setting can be selected when "Configuration" - "Height Speaker" is set to "Dolby Speaker".

#### □ Distance from the ceiling (Default Value: 6' 0"/1.80 m)

Set the distance between the Dolby Enabled Speaker and the ceiling. Select between "0.1 ft/0.03 m" and "15.0 ft/4.50 m" (0.1 ft/0.03 m units).

- The unit of distance (ft/m) is displayed using the unit selected for the "Distance" setting.

#### □ AccuReflex (Default Value: Off)

You can enhance the reflection effect of Dolby Enabled Speakers from the ceiling.

- The function is not effective if the listening mode is Direct.

Off	When this function is not used
On	When this function is used

### ■ 6. Speaker Virtualizer

The Speaker Virtualizer function can be switched between On and Off.

#### □ Speaker Virtualizer (Default Value: On)

On	Listening modes such as T-D that have virtual speaker effects can be selected.
Off	Listening modes such as T-D that have virtual speaker effects cannot be selected.

### ■ 7. Speaker Combo

"Speaker Combo" is a function that optimizes the crossover value suitable for Klipsch speakers.

Setting the Klipsch speaker model to be used with "Speaker Combo" updates the content of "Speaker" - "Crossover" on the Setup menu, and the crossover is set to the optimized value suitable for the speakers.

#### □ Brand (Default Value: Other)

Select the brand of your speakers.

Klipsch	When Klipsch speakers are used
Other	When other than Klipsch speakers are used

Front	(Default Value: Other)
Center	(Default Value: Other)
Height	(Default Value: Other)
Surround	(Default Value: Other)
Subwoofer	(Default Value: Other)

Select the model of your speakers.

Select "Other" if yours is not in the list.

"Series": Select the series of speaker.

"Model": Select the model of speaker.



## 3. Audio Adjust

### ■ 1. Multiplex/Mono

Change the settings of multiplex audio playback.

#### □ Multiplex Input Channel (Default Value: Main)

Set the audio channel or language to be output when playing multiplex audio or multilingual broadcasts, etc.

- For multiplex audio broadcasts, pressing the **i** INFORMATION button on the remote controller will display "1+1" on the main unit's display.

Main	Main channel only
Sub	Sub channel only
Main / Sub	Main and sub channels will be output at the same time.

#### □ Mono Input Channel (Default Value: Left + Right)

Set the input channel when playing back analog or 2 ch PCM signals in the Mono listening mode.

Left	Left channel only
Right	Right channel only
Left + Right	Left and right channels

### ■ 2. Dolby

Change the setting of when Dolby signals are input.

#### □ Loudness Management (Default Value: On)

When playing Dolby TrueHD, enable the dialog normalization function which keeps the volume of dialog at a certain level. Note that when this setting is Off, the Late Night function that allows you to enjoy surround at low volumes is fixed to off when playing Dolby Digital Plus/Dolby TrueHD.

On	When this function is used
Off	When this function is not used

#### □ Dialogue Enhancement (Default Value: Off)

Improves the intelligibility of dialogue by continually monitoring audio and applying dynamic processing.

On	When this function is used
Off	When this function is not used



## 3. Audio Adjust

### ■ 3. DTS

Change the setting of when DTS signals are input.

#### □ DTS Auto Surround (Default Value: On)

When inputting DTS signals that include extended channel information, the optimum listening mode is automatically selected according to the extended information contained in the input signal and the speaker configuration of this unit when playing in the straight decoding listening mode.

On	When this function is used
Off	Audio is played using the same amount of channels in the input signal according to the speaker configuration of this unit.

#### □ Dialog Control (Default Value: 0 dB)

You can increase the volume of dialog portion of the audio up to 6 dB by 1 dB step so that you can hear the dialog easily in noisy atmosphere.

- This cannot be set for content other than DTS:X.
- Depending on the content, this function may not be selected.

### ■ 4. LFE Level

Set the low-frequency effect (LFE) level for Dolby Digital series, DTS series, Multichannel PCM, and DSD signals.

#### □ LFE Level (Default Value: 0 dB)

Select the low-frequency effect (LFE) level of each signal from "0 dB" to "-∞ dB". If the low-frequency effect sound is too strong, select "-20 dB" or "-∞ dB".

### ■ 5. Volume

Change the Volume settings.

#### □ Volume Display (Default Value: Absolute)

Switch the volume display between the absolute value and relative value. The absolute value 82.0 is equivalent to the relative value 0.0 dB.

Absolute	Absolute value such as "0.5" and "99.5" • If the absolute value is set to 82.0, "82.0 Ref" will appear on the display.
Relative	Relative value such as "-81.0 dB" and "+18.0 dB"

#### □ Mute Level (Default Value: -∞ dB)

Set the volume lowered from the listening volume when muting is on. Select a value from "-∞ dB", "-40 dB", and "-20 dB".

#### □ Maximum Volume (Default Value: Off)

Set the maximum value to prevent the volume from becoming too loud. Select a value from "Off", and "50" to "99". (When "Volume Display" is set to "Absolute")

#### □ Power On Volume (Default Value: Last)

Set the volume level of when the power is turned on. Select a value from "Last" (Volume level before entering standby mode), "Min", "0.5" to "99.5" and "Max". (When "Volume Display" is set to "Absolute")

- You cannot set a higher value than that of "Maximum Volume".

#### □ Headphone Level (Default Value: 0.0 dB)

Adjust the output level of headphones. Select a value between "-12.0 dB" and "+12.0 dB".





## 4. Source

### ■ 1. My Input Volume

Set a volume value for each input selector.

#### □ My Input Volume (Default Value: Last)

Select a value from "Last", "Min", "0.5" to "81.5" and "Max". (When "Volume Display" is set to "Absolute")

- The volume level when the power is turned on is the value set for "Power On Volume".
- To set the volume to the current volume, press the button of the input selector you wish to set for approx. 3 seconds.

- This cannot be set if the "BLUETOOTH" input is selected.

### ■ 2. Name Edit

Set an easy name for each input. The set name appears on the main unit's display. Select the input selector to make the setting.

#### □ Name Edit (Default Value: Input name)

1. Select a character or symbol with the cursors, and press ENTER.

Repeat this operation to input up to 10 characters.

"A/a": Switches between upper and lower cases. (Pressing MODE on the remote controller also toggles between upper and lower cases)

"←" "→": Moves the cursor in the arrow direction.

"⊞": Removes a character on the left of the cursor.

"Space": Enters a space.

- Pressing CLEAR on the remote controller will remove all the input characters.

2. After inputting, select "OK" with the cursors, and press ENTER.

The input name will be saved.

To restore the name to the default value, press CLEAR on the remote controller on the input screen. Then while nothing is entered, select "OK", and press ENTER.

- To name a preset radio station, press TUNER on the remote controller, select AM(North American, Taiwanese, Middle East, Australian and Asian models)/ FM and select the preset number. (Preset names cannot be given to DAB stations (European models))



## 4. Source

### ■ Audio Select

Select the priority for input selection when multiple audio sources are connected to one input selector, such as connections to both the "CD" DIGITAL IN jack and the "CD" AUDIO IN jack. The setting can be separately set to each input selector button. Select the input selector to configure. Note that there are some default values you cannot change.

- BD/DVD** (Default Value: HDMI)
- GAME** (Default Value: HDMI)
- CBL/SAT** (Default Value: HDMI)
- STRM BOX** (Default Value: HDMI)
- PC** (Default Value: ---)
- AUX** (Default Value: ---)
- CD** (Default Value: COAXIAL)
- TV** (Default Value: ARC)

ARC	When giving priority to input signal from ARC compatible TV. <ul style="list-style-type: none"> <li>• The setting can be selected only when "Hardware" - "HDMI" - "Audio Return Channel (eARC supported)" is set to "On" and also the "TV" input is selected.</li> </ul>
HDMI	When giving priority to input signal from HDMI IN jacks <ul style="list-style-type: none"> <li>• This item can be selected only when the input to be set is assigned to the HDMI jack in the "Input/Output Assign" - "HDMI Input" setting.</li> </ul>
COAXIAL	When giving priority to input signal from DIGITAL IN COAXIAL jacks <ul style="list-style-type: none"> <li>• This item can be selected only when the input to be set is assigned to the COAXIAL jack in the "Input/Output Assign" - "Digital Audio Input" setting.</li> </ul>
OPTICAL	When giving priority to input signal from DIGITAL IN OPTICAL jacks <ul style="list-style-type: none"> <li>• This item can be selected only when the input to be set is assigned to the OPTICAL jack in the "Input/Output Assign" - "Digital Audio Input" setting.</li> </ul>

Analog	When giving priority to the input signal from AUDIO IN jacks <ul style="list-style-type: none"> <li>• This item can be selected only when the input to be set is assigned to the AUDIO IN jack in the "Input/Output Assign" - "Analog Audio Input" setting.</li> </ul>
--------	---

### PCM Fixed Mode (Default Value: Off)

Select whether to fix input signals to PCM (except multi-channel PCM) when you select "HDMI", "COAXIAL", or "OPTICAL" in the "Audio Select" setting. Set this item to "On" if noise is produced or truncation occurs at the beginning of a track when playing PCM sources. Select "Off" normally.

- Each time the "Audio Select" setting is changed, the setting is restored to "Off".
- The setting cannot be changed when "TUNER" or "BLUETOOTH" input is selected.



## 4. Source

### ■ Video Select

When the "TUNER" or "BLUETOOTH" input is selected, you can set the input from which video is displayed on the TV.

#### □ Video Select (Default Value: Last)

Last	Select the video input played immediately prior.
BD/DVD, GAME, CBL/SAT, STRM BOX, PC, CD, TV	Play the video of each input. <ul style="list-style-type: none"> <li>• This setting is effective for an input selector which is assigned in "Input/Output Assign" - "HDMI Input"</li> </ul>

- If the OSD language is set to Chinese, you can only select this setting when "TUNER" is selected as input. (European, Taiwanese, Middle East, Australian and Asian models)



## 5. Hardware

### 1. HDMI

Change the settings of the HDMI function.

#### □ HDMI CEC (Default Value: On)

Setting this to "On" enables the input selection link and other link functions with HDMI-connected CEC-compatible device.

When this setting is changed, turn off and then on again the power of all connected devices.

- Depending on the TV to use, a link setting may be required on the TV.
- Setting this to "On" and closing the operation screen will display the name of the connected CEC-compatible device and "CEC On" on the main unit's display.
- When this function is set to "On", the power consumption in standby state increases, however, the increase in power consumption is minimized by automatically entering the HYBRID STANDBY mode where only the essential circuits operate.
- If you operate the MASTER VOLUME dial on the main unit when this setting is "On" and audio is output from the TV speakers, audio will be output also from the speakers connected to this unit. To output audio from only either of them, change the setting of this unit or TV, or reduce the volume of this unit.
- If abnormal behavior is observed when this is set to "On", set it to "Off".
- If a connected device is not CEC-compatible, or if you are not sure whether it is compatible, set it to "Off".

On	When this function is used
Off	When this function is not used

#### □ HDMI Standby Through (Default Value: Auto (Eco))

When this is set to anything other than "Off", you can play the video and audio of an HDMI-connected player on the TV even if the unit is in standby mode. Also, only "Auto" and "Auto (Eco)" can be selected if "HDMI CEC" is set to "On". If you select anything else, set "HDMI CEC" to "Off".

- When this function is set to a value other than "Off", the power consumption in standby state increases, however, the increase in power consumption is minimized by automatically entering the HYBRID STANDBY mode where only the essential circuits operate.
- To play a non-CEC compliant player on the TV, turn the unit on and switch the input.
- When using a CEC-compliant TV, you can reduce the power consumption in standby mode by selecting "Auto (Eco)".

Off	When this function is not used
BD/DVD, GAME, CBL/SAT, STRM BOX, PC, CD, TV	For example, if you select "BD/DVD", you can play the equipment connected to the "BD/DVD" jack on the TV even if the unit is in standby mode. Select this setting if you have decided which player to use with this function. Inputs that have not been allocated to HDMI jacks in "Input/Output Assign" - "HDMI Input" cannot be selected. • Even when an HDMI IN jack has been allocated to TV, TV cannot be select when "Audio Return Channel (eARC supported)" (→p69) is set to "On".
Last	You can play on the TV the video and audio of the input selected immediately before the unit is switched to standby.
Auto, Auto (Eco)	Select one of these settings when you have connected equipment that conforms to the CEC standard. You can play the video and audio of the input selected on the TV, irrespective of what input was selected immediately prior to the unit being switched to standby, using the CEC link function.



## 5. Hardware

### □ Audio TV Out (Default Value: Auto)

You can enjoy audio through the speakers of the TV while this unit is on.

- Listening mode cannot be changed while "Audio TV Out" is set to "On" and audio is being output from the TV.
- Depending on your TV or input signal of the connected device, audio may not be output from the TV even if this is set to "On". In such a case, audio is output from the speakers of the unit.
- Audio is output from this unit if you operate the MASTER VOLUME dial on this unit when audio that is input to this unit is output from your TV speakers. If you do not want to output audio, change the setting of this unit or TV, or reduce the volume of this unit.

On	When this function is used
Off	When this function is not used
Auto	When the "HDMI CEC" setting is "On", the setting is fixed to "Auto". With "Auto", when audio is output from the TV speakers, audio is not output from the speakers of this unit, and when audio is output from the speakers of this unit, audio is not output from the TV speakers. <ul style="list-style-type: none"> <li>• If the HDMI CEC setting is off on the TV, there may be audio output from both the TV speakers and the speakers of this unit.</li> </ul>

### □ Audio Return Channel (eARC supported) (Default Value: On)

You can enjoy the sound of an HDMI-connected ARC-compatible TV or eARC-compatible TV through the speakers connected to the unit.

On	When enjoying the TV sound through the speakers connected to the unit
Off	When the ARC function or eARC function is not used

### □ Auto Lip Sync (Default Value: On)

Automatically corrects desynchronization between the video and audio signals based on the information from the HDMI Lip-Sync-compatible TV.

On	When enabling the automatic correction function
Off	When not using the automatic correction function



## 5. Hardware

### ■ 2. Bluetooth

Change the settings for the BLUETOOTH function.

- Wait for a while if "Bluetooth" cannot be selected. It can be selected when the BLUETOOTH function is activated.

#### □ Bluetooth Receiver (Default Value: On)

Select whether or not to use the function that receives audio from BLUETOOTH wireless technology enabled devices.

On	When this function is used
Off	When this function is not used

#### □ Auto Input Change (Default Value: On)

When a BLUETOOTH enabled device is played while it is connected to the unit, the input of the unit can be automatically switched to "BLUETOOTH".

On	The input will automatically become "BLUETOOTH" when a BLUETOOTH enabled device is connected.
Off	The function is disabled. <ul style="list-style-type: none"> <li>• If the input is not switched automatically, set this to "Off", and change the input manually.</li> </ul>

#### □ Auto Reconnect (Default Value: On)

This function automatically reconnects to the BLUETOOTH enabled device connected last when you change the input to "BLUETOOTH".

- This may not work with some BLUETOOTH enabled devices.

On	When this function is used
Off	When this function is not used

#### □ Pairing Information (Default Value: -)

You can initialize the pairing information stored on this unit. If you are no longer able to connect with a device you have paired, try doing this. ( →p86)

Pressing ENTER when "Clear" is displayed initializes the pairing information stored on this unit.

- This function does not initialize the pairing information on the BLUETOOTH enabled device. When pairing the unit again with the device, be sure to clear the pairing information on the BLUETOOTH enabled device beforehand. For information on how to clear the pairing information, refer to the instruction manual of the BLUETOOTH enabled device.

#### □ Device (Default Value: -)

Displays the name of the BLUETOOTH enabled device connected to the unit.

- The name is not displayed when "Status" is "Ready" and "Pairing".

#### □ Status (Default Value: -)

Displays the status of the BLUETOOTH enabled device connected to the unit.

Ready	Not paired
Pairing	Paired
Connected	Successfully connected



## 5. Hardware

### ■ 3. Power Management

Change the settings for the power-save function.

#### □ Sleep Timer (Default Value: Off)

30 minutes, 60 minutes, 90 minutes	You can allow the unit to enter standby automatically when the specified time has elapsed. Select a value from "30 minutes", "60 minutes" and "90 minutes".
Off	Does not turn the unit to standby automatically.

#### □ Auto Standby (Default Value: On/Off)

This setting allows the unit to enter standby mode automatically after 20 minutes of inactivity without any video or audio input. (When "USB Power Out at Standby" is enabled, the unit enters the HYBRID STANDBY mode which minimizes the increase in power consumption.)

- Default values vary depending on the regions.

On	The unit will automatically enter standby mode ("AUTO STBY" will light). <ul style="list-style-type: none"> <li>• "Auto Standby" is displayed on the main unit's display and TV screen 30 seconds before entering standby mode.</li> </ul>
Off	The unit will not automatically enter standby mode.

#### □ Auto Standby in HDMI Standby Through (Default Value: On/Off)

Enable or disable "Auto Standby" while "HDMI Standby Through" is on.

- Default values vary depending on the regions.

On	The setting will be enabled. <ul style="list-style-type: none"> <li>• This setting cannot be set to "On" if "Auto Standby" and "HDMI Standby Through" are set to "Off".</li> </ul>
Off	The setting will be disabled.

#### □ USB Power Out at Standby (Default Value: Off)

Devices connected to the USB port (5 V/1 A) on the rear of the unit can be supplied with electricity even when this unit is in standby mode when this function is "On".

- When this function is set to "On", the power consumption in standby state increases, however, the increase in power consumption is minimized by automatically entering the HYBRID STANDBY mode where only the essential circuits operate.



## 6. Miscellaneous

### ■ 1. Tuner

Change the settings for Tuner.

#### AM/FM Frequency Step (North American and Taiwanese models) (Default Value: 10 kHz / 0.2 MHz)

Select a frequency step to suit your residential area.

Select "10 kHz/0.2 MHz" or "9 kHz/0.05 MHz".

- When this setting is changed, all radio presets are deleted.

#### AM Frequency Step (Middle East, Australian and Asian models) (Default Value: 9 kHz)

Select a frequency step to suit your residential area.

Select "10 kHz" or "9 kHz".

- When this setting is changed, all radio presets are deleted.

#### FM Search Level (European models) (Default Value: Normal)

If automatic tuning regularly stops on FM stations with weak reception when "Normal" is selected, select "Strong" so only those FM stations with strong reception are selected.

#### DAB Auto Scan (European models) (Default Value: -)

You can run the auto scan when new DAB stations are added or when you move house.

#### DAB DRC (European models) (Default Value: Off)

With the DRC (Dynamic Range Control) setting, you can reduce the dynamic range of DAB digital radio so that you can still hear quiet parts even when listening at low volume levels - ideal for listening to the radio late at night when you don't want to disturb anyone.

Off	DRC off
Large	Large reduction in dynamic range
Small	Small reduction in dynamic range





## 6. Miscellaneous

### ■ 2. Firmware Update

Change the settings for Firmware Update.

#### □ Version (Default Value: -)

The current firmware version is displayed.

#### □ Update via USB (Default Value: -)

Press ENTER to select when updating the firmware via USB.

- Wait for a while if "Firmware Update" cannot be selected.

### ■ 3. Initial Setup

Make the initial setup from the setup menu.

- Wait for a while if "Initial Setup" cannot be selected.

### ■ 4. Lock

Lock the Setup menu so that the settings cannot be changed.

#### □ Setup Parameter (Default Value: Unlocked)

Lock the Setup menu so that the settings cannot be changed.

Locked	The menu is locked.
Unlocked	The menu is unlocked.

### ■ 5. Factory Reset

All the settings are restored to factory defaults.

#### □ Factory Reset (Default Value: -)

All the settings are restored to factory defaults.

Select "Start" and press ENTER.

- If "Factory Reset" is performed, your settings are restored to the default values. Be sure to note down your setting contents beforehand.



# Initial Setup with Auto Start-up Wizard

## Operations

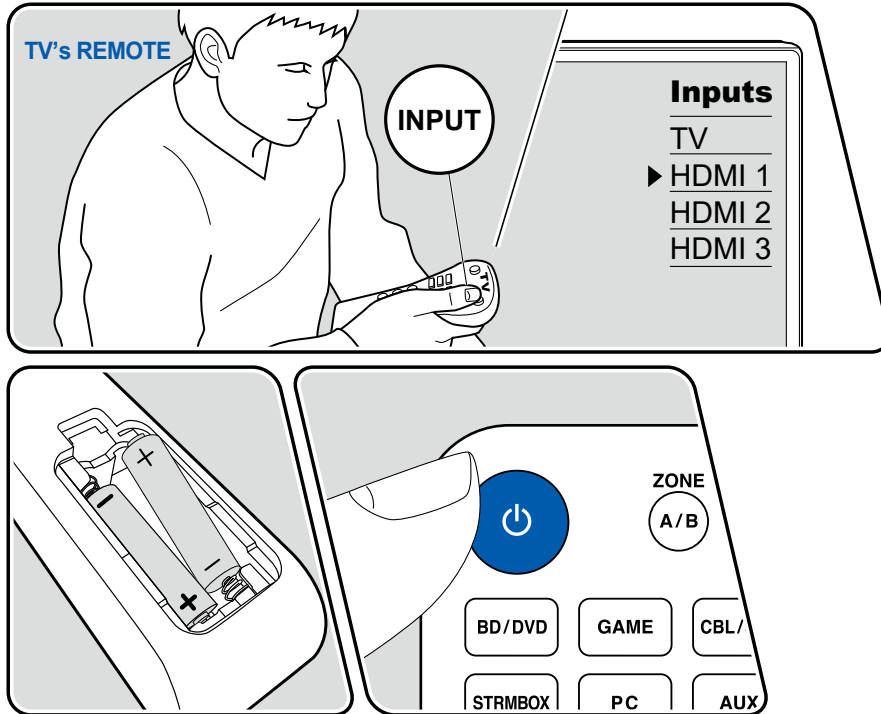

When you turn the unit on for the first time after purchase, the Initial Setup screen is automatically displayed on the TV to allow you to make settings required for startup using simple operations following on-screen guidance.

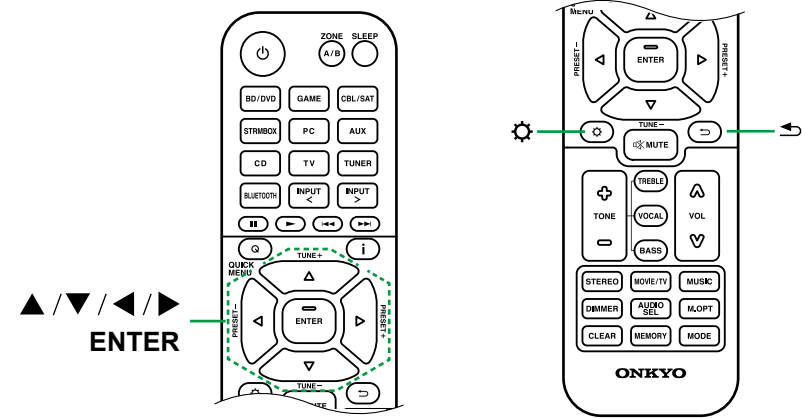

1. Switch the input of the TV to the input connected to the unit.
2. Put batteries into the remote controller of this unit.
3. Press **ON/STANDBY** on the remote controller to turn the unit on.
4. When the language selection screen is displayed on TV, select the language with the cursors **▲ / ▼ UP/DOWN** and press **ENTER**.
  - Select the item with the cursors of the remote controller, and press **ENTER** to confirm your selection. To return to the previous screen, press **RETURN/EXIT**.
  - If you have terminated the Initial Setup halfway, turn this unit to standby mode and turn the power on again. Then you can display the Initial Setup again. The Initial Setup appears on the screen each time the power is turned on unless the Initial Set up is completed or "Never Show Again" is selected on the first screen.



- To perform the Initial Setup again after the setting is completed, press **⚙️ SETUP**, select "Miscellaneous" - "Initial Setup", and press ENTER.

## 1. Speaker Setup

- Select the connected speaker configuration and press ENTER.  
Note that the image on the screen changes each time you select the number of channels in "Speaker Channels".

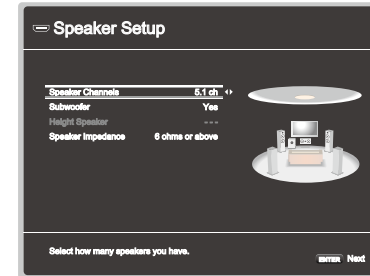

- The speaker combination selected in step 1 is displayed. "Yes" is displayed for the selected speakers. If the setting is correct, press ENTER.
- Select "Next" and press ENTER. Then a test tone is output from each speaker to confirm the connection. Selecting each speaker with the cursors **▲** / **▼** UP/DOWN will output the test tone. Press ENTER after confirmation.
- If there is no problem with the speaker connection, select "Next" and press ENTER. To return to "Speaker Setup", select "Back to Speaker Setup" and press ENTER.

## 2. ARC Setup

If you have connected a TV that supports ARC, select "Yes" and press ENTER.



### 3. AccuEQ Room Calibration

Place the supplied speaker setup microphone at the listening position. The unit automatically measures the test tones output from each speaker, and sets the optimum volume level for each speaker, the crossover frequencies, and the distance from the listening position. This also reduces the effect of the standing wave in accordance with the viewing environment and automatically adjusts the equalizers for the speakers, and enables correction of sound distortion caused by the acoustic environment of the room.

- It takes between 3 and 12 minutes for calibration to be completed.
  - If you connect a subwoofer, check the power and volume of the subwoofer. Set the subwoofer volume to more than half.
  - If the power of this unit suddenly turns off, the wires in the speaker cables have touched the rear panel or other wires, and the protection circuit is working. Twist the wires again securely, and make sure they do not stick out of the speaker terminals when connecting.
1. Connect the supplied speaker setup microphone to the SETUP MIC jack on the main unit.

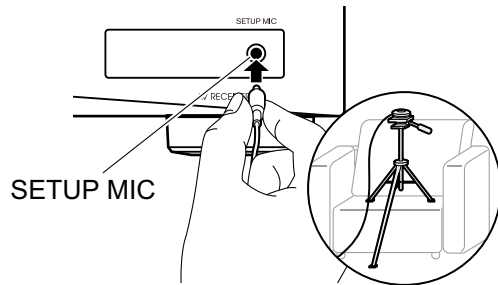

When placing the speaker setup microphone on a tripod, refer to the illustration.

2. Confirm a test tone is output from the subwoofer and press ENTER.
3. Press ENTER to output test tones from each speaker, and the connected speakers and the noise in the surrounding environment are automatically measured.
4. The measurement results in step 3 are displayed. If there is no problem in the detection result of the speaker, select "Next" and press ENTER to output the test tone again to automatically set the settings such as volume level,

crossover frequency, etc., to their optimum. (The test tone is automatically output when 10 seconds has elapsed without any operation.)

- When an error message is displayed or when the connected speakers cannot be detected, perform re-measurement by selecting "Retry" and pressing ENTER.
  - When it cannot be resolved by performing the re-measurement, confirm if the speakers are connected correctly. If there is any problem with the speaker connection, perform the connection after disconnecting the power cord.
5. When the measurement is completed, the measurement results are displayed. You can check each setting using the cursors ◀ / ▶ LEFT/RIGHT. Select "Save" and press ENTER to save the settings.
  6. Disconnect the speaker setup microphone.



## Troubleshooting

<b>Before starting the procedure</b>	<b>78</b>
<b>When the unit is operating erratically</b>	<b>79</b>
Try restarting the unit	79
Resetting the unit (this resets the unit settings to the default)	79
<b>Troubleshooting</b>	<b>80</b>
■ Power	80
■ Audio	81
■ Listening Modes	83
■ Video	84
■ Linked operation	85
■ Tuner	85
■ BLUETOOTH function	85
■ ZONE B function	86
■ Remote Controller	86
■ Display	87
■ Others	87



## Before starting the procedure

Problems may be solved by simply turning the power on/off or disconnecting/connecting the power cord, which is easier than working on the connection, setting and operating procedure. Try the simple measures on both the unit and the connected device. If the problem is that the video or audio is not output or the HDMI linked operation does not work, disconnecting/connecting the HDMI cable may solve it. When reconnecting, be careful not to wind the HDMI cable since if wound the HDMI cable may not fit well. After reconnecting, turn off and on the unit and the connected device.

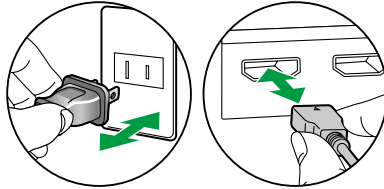

- The AV receiver contains a microPC for signal processing and control functions. In very rare situations, severe interference, noise from an external source, or static electricity may cause it to lockup. In the unlikely event that this happens, unplug the power cord from the wall outlet, wait at least 5 seconds, and then plug it back in.
- Our company is not responsible for damages (such as CD rental fees) due to unsuccessful recordings caused by the unit's malfunction. Before you record important data, make sure that the material will be recorded correctly.



## When the unit is operating erratically

### ❑ Try restarting the unit

Restarting this unit may solve the problem. Set the main unit to standby, then after waiting for 5 seconds or more, press and hold the  $\text{ON/STANDBY}$  button of the main unit for at least 5 seconds, and then restart the unit. (The settings on this unit are kept.) If the problem persists after restarting the unit, unplug and plug the power cords or HDMI cable of this unit and connected devices.

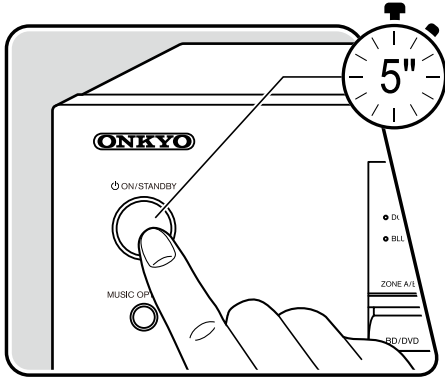

### ❑ Resetting the unit (this resets the unit settings to the default)

If the restart of the unit does not solve the problem, reset the unit, and restore all the settings to the factory default at the time of purchase. This may solve the problem. If the unit is reset, your settings are restored to the default values. Be sure to note down your setting contents before performing the following operations. Note that it is not possible to reset the unit during the Initial Setup process. Before doing the following procedures, press  $\text{RETURN/EXIT}$  to exit Initial Setup.

1. While pressing and holding CBL/SAT of the input selector on the main unit with the unit turned on, press the  $\text{ON/STANDBY}$  button.
2. "Clear" is displayed on the display, and the unit returns to the standby state. Do not remove the power cord until "Clear" disappears from the display. To reset the remote controller, while pressing and holding MODE, press the CLEAR button at least 3 seconds.

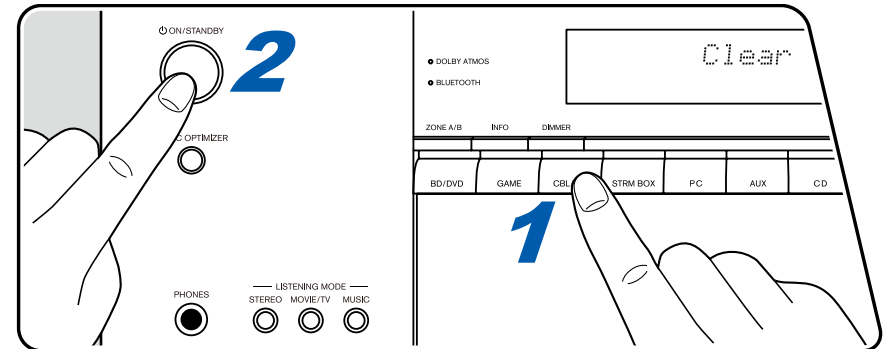

## Troubleshooting

### ■ Power

#### ❑ When the power is turned on, "Diagnostic mode" appears on the display of the main unit

- The protection circuit function may have operated. If the unit suddenly enters the standby state and "Diagnostic mode" appears on the display of the main unit when the power is turned on again, this function is diagnosing whether or not the main unit is malfunctioning or there is an abnormality with the speaker cable connection. When the diagnosis is complete, the following messages are displayed.

Check speaker	If the unit returns to the normal ON state after "Diagnostic mode" appears on the display, the speaker cable may have been short-circuited. After setting the power of this unit to standby state, connect the speaker cable again. Twist the wires exposed from the tip of the speaker cable so that the wires do not stick out of the speaker terminal.
NG: ****	If the operation has stopped with "NG" displayed on the display, set the power of this unit to standby state immediately and remove the power plug from the outlet. The unit may be malfunctioning. Consult a dealer.

#### ❑ The unit turns off unexpectedly

- If "Hardware" - "Power Management" - "Auto Standby" on the Setup menu is activated, the unit automatically enters the standby mode. (→p71)
- The protection circuit function may have operated due to an abnormal rise in temperature of the unit. In such a case, the power turns off repeatedly even if the power is turned on each time. Secure sufficient ventilation space around the unit, wait for a while until the temperature of the unit decreases. Then, turn the power on again.

**WARNING:** If smoke, smell or abnormal noise is produced by the unit, unplug the power cord from the outlet immediately, and contact the dealer or our company's support.





## ■ Audio

- Make sure that the speaker setup microphone is no longer connected.
- Confirm that the connection between the output jack on the connected device and the input jack on this unit is correct.
- Make sure that none of the connecting cables are bent, twisted, or damaged.
- If "MUTING" is displayed on the display and MUTE is blinking, press  MUTE on the remote controller to cancel muting.
- While headphones are connected to the PHONES jack, no sound is output from the speakers.
- When "Source" - "Audio Select" - "PCM Fixed Mode" on the Setup menu is set to "On", audio is not played if signals other than PCM are input. Change the setting to Off.

Check the following if the problem persists after you have confirmed the above.

### ❑ No sound from the TV

- Change the input selector on this unit to the position of the terminal to which the TV is connected.
- If the TV doesn't support the ARC function, along with connection by HDMI, connect the TV and this unit using a digital optical cable. ( →[p27](#))

### ❑ No sound from a connected player

- Change the input selector on this unit to the position of the jack to which the player is connected.
- Check the digital audio output setting on the connected device. On some game consoles, such as those supporting DVD, the default setting may be off.
- For some DVD-Video discs, you need to select an audio output format from a menu.

### ❑ A speaker produces no sound

- Make sure that the polarity (+/-) of the speaker cables is correct, and that no bare wires are in contact with the metal part of speaker terminals. ( →[p20](#))
- Make sure that the speaker cables are not shorting out.
- Check "Connect the Speaker Cables" ( →[p20](#)) to see if the speaker connections have been made correctly. Settings for the speaker connection environment need to be made in "Speaker Setup" in Initial Setup. Check "Initial Setup with Auto Start-up Wizard" ( →[p74](#)).
- Depending on the input signal and listening mode, not much sound may be output from speakers. Select another listening mode to see if sound is output.



## ❑ The subwoofer produces no sound

If the setting of the front speakers is "Full Band", the low range elements will be output from the front speakers instead of from the subwoofer during 2 ch audio input of TV or music. To output the sound from the subwoofer, make one of the following settings.

1. Change the setting for the front speakers to a setting of crossover frequency value other than "Full Band".  
The range below the specified frequency will be output from the subwoofer instead of from the front speakers. If your front speakers have a high low-range reproduction capability, changing this setting is not recommended.
2. Change "Double Bass" to "On".  
The low range elements of the front speakers will be output from both the front speakers and the subwoofer. Due to this, the bass sound may be emphasized too much. In such a case, do not change the setting, or make the setting with the above option 1.
  - For the setting details, refer to "Speaker" - "Crossover" on the Setup menu. ( →p60)
  - If the input signals do not contain subwoofer audio elements (LFE), the subwoofer may produce no sound.

## ❑ Noise can be heard

- Using cable ties to bundle analog audio cables, power cords, speaker cables, etc. may degrade the audio performance. Do not bundle the cords.
- An audio cable may be picking up interference. Change the position of the cables.

## ❑ The beginning of audio received by an HDMI IN cannot be heard

- Since it takes longer to identify the format of an HDMI signal than it does for other digital audio signals, audio output may not start immediately.

## ❑ Sound suddenly reduces

- When the temperature inside the unit exceeds a certain temperature for extended periods of use, the volume may be lowered automatically to protect the circuits.

## ❑ Sound suddenly changes

- When "My Input Volume" is set, the volume is set for each input selector. Check "Source" - "My Input Volume" on the Setup menu. ( →p65)



## ■ Listening Modes

- To enjoy digital surround playback in formats such as Dolby Digital, you need to make a connection for audio signals with an HDMI cable, digital coaxial cable or digital optical cable. Also, audio output need to be set to Bitstream output on the connected Blu-ray Disc player, etc.
  - Press **i** INFORMATION on the remote controller several times to switch the display of the main unit, and you can check the input format.
- Check the following if the problem persists after you have confirmed the above.

### ❑ Cannot select a desired listening mode

- Depending on the connection status of the speaker, some listening modes may not be selected. Check "Speaker Layouts and Selectable Listening Modes" (→[p89](#)) or "Input Formats and Selectable Listening Modes" (→[p92](#)).

### ❑ Cannot listen to the sound in Dolby TrueHD, Dolby Atmos or DTS-HD Master Audio format

- If the audio in Dolby TrueHD, Dolby Atmos or DTS-HD Master Audio format cannot be output correctly in the source format, set "BD video supplementary sound" (or reencode, secondary sound, video additional audio, etc.) to "Off" in the setting of a connected Blu-ray Disc player, etc. After changing the setting, switch the listening mode to that for each source, and confirm.

### ❑ About Dolby signals

- Some Dolby Atmos audio format that is used on games, etc., may be recognized as "Multichannel PCM". If this occurs, check the firmware updates for the game console.

### ❑ About DTS signals

- With media that switches suddenly from DTS to PCM, PCM playback may not start immediately. In such a case, stop playback on the player side for approx. 3 seconds or more. Then, resume playback. The playback will be performed normally.
- DTS playback may not be performed normally on some CD and LD players even if the player and this unit are digitally connected. If some processing (e.g., output level adjustment, sampling frequency conversion, or frequency characteristic conversion) has been executed for the DTS signal being output, this unit cannot recognize it as a genuine DTS signal, and noise may occur.
- While playing a DTS-compatible disc, if a pause or skip operation is performed on your player, noise may occur for a short period. This is not a malfunction.



## ■ Video

- Confirm that the connection between the output jack on the connected device and the input jack on this unit is correct.
  - Make sure that none of the connecting cables are bent, twisted, or damaged.
  - When the TV image is blurry or unclear, the power cord or connection cables of the unit may have interfered. In such a case, keep distance between TV antenna cable and cables of the unit.
  - Check the switching of the input screen on the monitor side such as a TV.
- Check the following if the problem persists after you have confirmed the above.

### □ No image appears

- Change the input selector on this unit to the position of the jack to which the player is connected.
- To display video from the connected player on the TV while the unit is in standby, you need to enable "Hardware" - "HDMI" - "HDMI Standby Through" on the Setup menu. For details of the HDMI Standby Through function, check "Hardware" - "HDMI" on the Setup menu. (→p68)
- Check if "Resolution Error" is displayed on the main unit display when video input via HDMI IN jack is not displayed. In this case, the TV does not support the resolution of the video input from the player. Change the setting on the player.
- Normal operation with an HDMI-DVI adapter is not guaranteed. In addition, video signals output from a PC are not guaranteed.
- Try switching off the Deep Color function. To turn off the Deep Color function, simultaneously press the STRM BOX and ⏻ ON/STANDBY buttons on the main unit. While holding down STRM BOX, press ⏻ ON/STANDBY repeatedly until "Deep Color:Off" appears on the display. To reactivate the Deep Color function, repeat the above described step until "Deep Color:On" is appeared on the display.

### □ Images flicker

- The output resolution of the player may not be compatible with the resolution of the TV. If the player is connected to this unit with an HDMI cable, change the output resolution on the player. Also this may be solved by changing the screen mode on the TV.

### □ Video and audio are out of sync

- Depending on the settings on your TV and connection environment, the video may be behind the audio. Press **Q** QUICK MENU on the remote controller to display "Quick Menu", select "HDMI" - "A/V Sync", and make the adjustment. (→p46)



## ■ Linked operation

### ❑ HDMI linked operation does not work with CEC-compliant devices, such as a TV

- In the Setup menu of the unit, set "Hardware" - "HDMI" - "HDMI CEC" to "On".
- It is also necessary to set HDMI linking on the CEC-compliant device. Check the instruction manual.
- When connecting a Sharp brand player or recorder to the HDMI IN jacks, set "Hardware" - "HDMI" - "HDMI Standby Through" to "Auto" on the Setup menu.

( →p68)

## ■ Tuner

### ❑ Poor reception or much noise

- Recheck the antenna connection.
- Move the antenna away from the speaker cord or power cord.
- Move the unit away from your TV or PC.
- Passing cars or airplanes in the vicinity can cause interference.
- If radio waves are blocked by concrete walls, etc., radio reception may be poor.
- Change the reception mode to mono ( →p40).
- When listening to an AM station, operating the remote controller may cause noise. (North American, Taiwanese, Middle East, Australian and Asian models)
- FM reception may be clearer if you use the antenna jack on the wall used for the TV.

( →p32)

## ■ BLUETOOTH function

- Unplug and plug the power cord of the unit, or turn off and on the BLUETOOTH enabled device. Restart of the BLUETOOTH enabled device may be effective.
- BLUETOOTH enabled devices must support the A2DP profile.
- Because a radio wave interference will occur, this unit may not be used near devices such as a microwave oven or cordless phone which use the radio wave in the 2.4 GHz range.
- A metallic object near the unit can affect on the radio wave, and BLUETOOTH connection may not be possible.

Check the following if the problem persists after you have confirmed the above.

### ❑ Cannot transmit from a BLUETOOTH wireless technology enabled device (PC, smartphone, etc.) to this unit

- Check if the BLUETOOTH function of the BLUETOOTH enabled device is enabled.



## ❑ Cannot connect a BLUETOOTH wireless technology enabled device (PC, smartphone, etc.) to this unit

- Initialize the pairing information and perform pairing again.  
Firstly delete all the pairing information saved on this unit. In the Setup menu, select "Hardware" - "Bluetooth" - "Bluetooth Receiver"- "Pairing Information", then press ENTER while "Clear" is displayed.  
Next, delete the pairing information of this unit that is saved on the BLUETOOTH wireless technology enabled device. For information on how to clear the pairing information, refer to the BLUETOOTH enabled device's instruction manual.  
Finally, perform pairing again. Refer to "BLUETOOTH® Playback" ( →p39) for pairing instructions.

## ❑ Music playback is unavailable on the unit even after successful BLUETOOTH connection

- If the volume setting on this unit or the BLUETOOTH wireless technology enabled device is low, audio may not be played. Check the volume setting on this unit or the BLUETOOTH wireless technology enabled device.
- Some Bluetooth enabled devices may be equipped with a Send/Receive selector switch. Try switching the setting to suit the application the device is being used for.
- Depending on the characteristics or specifications of the BLUETOOTH enabled device, music may not be played back on this unit.

## ❑ Sound is interrupted

- There maybe a problem with the BLUETOOTH enabled device. Check the information on a web page.

## ❑ The audio quality is poor after connection with a BLUETOOTH enabled device

- The BLUETOOTH reception is poor. Move the BLUETOOTH enabled device closer to the unit, or remove any obstacle between the BLUETOOTH enabled device and this unit.

## ■ ZONE B function

### ❑ Cannot output audio to ZONE B

- To output audio to ZONE B, set the audio output destination to "ZONE A+B" or "ZONE B".

( →p48)

## ■ Remote Controller

- Make sure that the batteries are inserted with the correct polarity.
- Insert new batteries. Do not mix different types of batteries, or old and new batteries.
- Make sure that the sensor of the main unit is not subjected to direct sunlight or inverter-type fluorescent lights. Relocate it if necessary.
- If the main unit is installed in a rack or cabinet with colored-glass doors, or if the doors are closed, the remote controller may not work normally.



## ■ Display

### ❑ The display does not light up

- When the Dimmer function is working, the display may go dim. Press the DIMMER button, and change the brightness level of the display.

( →[p14](#))

## ■ Others

### ❑ Strange noise can be heard from the unit

- If you have connected another device to the same outlet as this unit, strange noise may occur under the influence of the device. If the symptom is remedied by removing the power plug of the other device from the outlet, use different outlets for this unit and the device.

### ❑ The message "Noise Error" appears during AccuEQ Room Calibration

- This can be caused by a malfunction in your speaker unit. Check the speaker output, etc.

### ❑ The measurement results of AccuEQ Room Calibration show different distances to the speakers from the actual ones

- Depending on the speakers you are using, some errors may occur in the measurement results. If this is the case, make the settings in "Speaker" - "Distance" in the Setup menu.

( →[p61](#))

### ❑ The measurement results of AccuEQ Room Calibration show that the volume level of the subwoofer has been corrected to the lower limit

- The volume level correction of the subwoofer may not have been completed. Lower the volume of the subwoofer before AccuEQ Room Calibration measurement.



# Appendix

Speaker Layouts and Selectable Listening Modes	89
LISTENING MODE buttons and Selectable Listening Modes	91
Input Formats and Selectable Listening Modes	92
Listening Mode Effects	95
Speaker Combinations	99
<b>General Specifications</b>	<b>100</b>





## Speaker Layouts and Selectable Listening Modes

See the following table for selectable listening modes for each speaker layout.

Listening mode	Speaker layout (ch)					
	2.1	3.1	4.1	5.1	2.1.2	3.1.2
<input checked="" type="checkbox"/> DD (Dolby Audio - DD)		✓(*1)	✓(*1)	✓(*1)		✓(*2)
<input checked="" type="checkbox"/> DD+ (Dolby Audio - DD+)		✓(*1)	✓(*1)	✓(*1)		✓(*1)
<input checked="" type="checkbox"/> DTHD (Dolby Audio - TrueHD)		✓(*1)	✓(*1)	✓(*1)		✓(*1)
<input checked="" type="checkbox"/> Atmos 2.0/2.1	✓					
<input checked="" type="checkbox"/> Atmos 3.0/3.1		✓				
<input checked="" type="checkbox"/> Atmos 4.0/4.1			✓			
<input checked="" type="checkbox"/> Atmos 5.0/5.1				✓		
<input checked="" type="checkbox"/> Atmos 2.0.2/2.1.2					✓	
<input checked="" type="checkbox"/> Atmos 3.0.2/3.1.2						✓
Dolby Surr 2.0/2.1 (Dolby Audio - Surr)	✓					
Dolby Surr 3.0/3.1 (Dolby Audio - Surr)		✓				
Dolby Surr 4.0/4.1 (Dolby Audio - Surr)			✓			
Dolby Surr 5.0/5.1 (Dolby Audio - Surr)				✓		
Dolby Surr 2.0.2/2.1.2 (Dolby Audio - Surr)					✓	
Dolby Surr 3.0.2/3.1.2 (Dolby Audio - Surr)						✓



Listening mode	Speaker layout (ch)					
	2.1	3.1	4.1	5.1	2.1.2	3.1.2
DTS		✓	✓	✓		✓(*2)
DTS-HD		✓	✓	✓		✓
DTS:X		✓	✓	✓	✓	✓
DTS Neural:X	✓	✓	✓	✓	✓	✓
Multich (Multichannel)		✓(*1)	✓(*1)	✓(*1)		✓(*2)
DSD		✓(*1)	✓(*1)	✓(*1)		✓(*2)
Direct	✓	✓(*1)	✓(*1)	✓(*1)	✓(*1)	✓(*1)
Stereo	✓	✓(*3)	✓(*3)	✓(*3)	✓(*3)	✓(*3)
Mono	✓	✓(*3)	✓(*3)	✓(*3)	✓(*3)	✓(*3)
Mono Music		✓	✓	✓	✓	✓
AllCh Stereo		✓	✓	✓	✓	✓
Orchestra			✓	✓	✓	✓
Studio-Mix			✓	✓	✓	✓
TV Logic			✓	✓	✓	✓
Unplugged			✓	✓	✓	✓
T-D (Theater-Dimensional)	✓	✓	✓(*3)	✓(*4)	✓(*3)	✓(*4)

\*1: Reproduced with the sound field according to the number of channels of input signals.

\*2: Not output from height speakers.

\*3: Output only from front speakers.

\*4: Output only from front speakers and center speaker.



## LISTENING MODE buttons and Selectable Listening Modes

Refer to the following table for the listening modes that can be selected with each LISTENING MODE button.

Listening mode	LISTENING MODE button		
	STEREO	MOVIE/TV	MUSIC
<input checked="" type="checkbox"/> DD (Dolby Audio - DD)		✓	✓
<input checked="" type="checkbox"/> DD+ (Dolby Audio - DD+)		✓	✓
<input checked="" type="checkbox"/> DTHD (Dolby Audio - TrueHD)		✓	✓
<input checked="" type="checkbox"/> Atmos 2.0/2.1		✓	✓
<input checked="" type="checkbox"/> Atmos 3.0/3.1		✓	✓
<input checked="" type="checkbox"/> Atmos 4.0/4.1		✓	✓
<input checked="" type="checkbox"/> Atmos 5.0/5.1		✓	✓
<input checked="" type="checkbox"/> Atmos 2.0.2/2.1.2		✓	✓
<input checked="" type="checkbox"/> Atmos 3.0.2/3.1.2		✓	✓
Dolby Surr 2.0/2.1 (Dolby Audio - Surr)		✓	✓
Dolby Surr 3.0/3.1 (Dolby Audio - Surr)		✓	✓
Dolby Surr 4.0/4.1 (Dolby Audio - Surr)		✓	✓
Dolby Surr 5.0/5.1 (Dolby Audio - Surr)		✓	✓
Dolby Surr 2.0.2/2.1.2 (Dolby Audio - Surr)		✓	✓
Dolby Surr 3.0.2/3.1.2 (Dolby Audio - Surr)		✓	✓
DTS		✓	✓
DTS-HD		✓	✓
DTS:X		✓	✓
DTS Neural:X		✓	✓

Listening mode	LISTENING MODE button		
	STEREO	MOVIE/TV	MUSIC
Multich (Multichannel)		✓	✓
DSD		✓	✓
Direct		✓	✓
Stereo	✓		✓
Mono		✓	
Orchestra			✓
Unplugged			✓
Studio-Mix			✓
TV Logic		✓	
AllCh Stereo		✓	✓
Mono Music			✓
T-D (Theater-Dimensional)		✓	



## Input Formats and Selectable Listening Modes

You can select a variety of listening modes according to the audio format of the signal to be input.

- Selectable listening modes when headphones are connected are Mono, Direct, and Stereo only.

Input format	Listening mode					
	Direct Stereo	DD (Dolby Audio - DD) (*1)	DD+ (Dolby Audio - DD+) (*1)(*2)	DTHD (Dolby Audio - TrueHD) (*1)	Atmos (*8)	Dolby Surr (Dolby Audio - Surr) (*8)
<b>2-channel signal input</b>						
Analog / PCM	✓					✓
DSD	✓					✓
DD / DD+ / DTHD	✓					✓
DTS / DTS 96/24 / DTS Express / DTS-HD HR / DTS-HD MSTR (*10) (*11)	✓					✓(*9)
<b>Multi-channel signal input</b>						
Multich PCM	✓					✓
DSD	✓					✓
DD	✓	✓				✓
DD+	✓		✓			✓
DTHD	✓			✓		✓
Atmos	✓				✓	
DTS	✓					✓
DTS 96/24 (*10)	✓					✓
DTS Express (*11)	✓					
DTS-HD HR (*11)	✓					✓
DTS-HD MSTR (*11)	✓					✓
DTS-ES Discrete (*10)	✓					✓
DTS-ES Matrix (*10)	✓					✓
DTS:X	✓					



Listening mode Input format	DTS (*1)	DTS-HD (*1)	DTS:X	DTS Neural:X (*3)	PCM (Multich PCM) (*1)	DSD (*1)(*7)	Mono	Orchestra/ Unplugged/ Studio-Mix/ TV Logic (*4)	AllCh Stereo / Mono Music (*5)	T-D (Theater-Dimensional) (*6)
	<b>2-channel signal input</b>									
Analog / PCM				✓			✓	✓	✓	✓
DSD				✓				✓	✓	✓
DD / DD+ / DTHD				✓				✓	✓	✓
DTS / DTS 96/24 / DTS Express / DTS-HD HR / DTS-HD MSTR (*10) (*11)				✓				✓	✓	✓
<b>Multi-channel signal input</b>										
Multich PCM				✓	✓			✓	✓	✓
DSD				✓		✓		✓	✓	✓
DD				✓				✓	✓	✓
DD+				✓				✓	✓	✓
DTHD				✓				✓	✓	✓
Atmos								✓	✓	✓
DTS	✓			✓				✓	✓	✓
DTS 96/24 (*10)	✓			✓				✓	✓	✓
DTS Express (*11)		✓		✓				✓	✓	✓
DTS-HD HR (*11)		✓		✓				✓	✓	✓
DTS-HD MSTR (*11)		✓		✓				✓	✓	✓
DTS-ES Discrete (*10)	✓			✓				✓	✓	✓
DTS-ES Matrix (*10)	✓			✓				✓	✓	✓
DTS:X			✓					✓	✓	✓



- (\*1) A center speaker or surround speakers need to be installed.
- (\*2) If the input source is Blu-ray Disc and the speaker layout is 5.1 ch or less, DD+ cannot be selected. Instead, the listening mode for DD can be selected.
- (\*3) If the input format is any of the following and the number of channels is monaural, this listening mode becomes unavailable.
  - DTS, DTS 96/24, DTS Express, DTS-HD HR, DTS-HD MSTR, PCM
- (\*4) Surround speakers or height speakers need to be installed.
- (\*5) A center speaker, surround speakers, or height speakers need to be installed.
- (\*6) Cannot be selected if "Speaker Virtualizer" ( →[p62](#)) is set to "Off".
- (\*7) Cannot be selected when the input format is monaural.
- (\*8) The listening mode displayed depends on the speaker layout ( →[p89](#)). Furthermore, when the setting for "Speaker Virtualizer" ( →[p62](#)) is "Off" (the default value is On), then modes other than  Atmos and Dolby Surr cannot be selected.
- (\*9) This cannot be selected when the input format is DTS Express.
- (\*10) Displayed as "DTS" on this unit.
- (\*11) Displayed as "DTS-HD" on this unit.

## Speaker Layouts and Selectable Listening Modes ( →[p89](#))



## Listening Mode Effects

### In alphabetical order

#### ■ AllCh Stereo







This mode is ideal for background music. Stereo sound is played through the surround speakers as well as the front speakers, creating a stereo image.

#### ■ Atmos

Since this mode calculates the positional data of audio recorded in Dolby Atmos audio in real-time and outputs it from appropriate speakers, you can enjoy the natural and stereophonic sound field of Dolby Atmos with any speaker layout including connection of only front speakers. Also, the Dolby Atmos sound design can be reproduced more faithfully by connecting height speakers. You can select this mode when inputting the Dolby Atmos audio format.

Unlike existing surround systems, Dolby Atmos does not rely on channels, but rather enables the accurate placement of sound objects that have independent motion in a 3D space with even greater clarity. Dolby Atmos is an optional audio format for Blu-ray Discs and achieves a more stereophonic sound field by introducing a sound field above the listener.

According to the speaker layout, the following listening modes are displayed.

-  Atmos 2.0/2.1: When only front speakers are installed
  -  Atmos 3.0/3.1: When front speakers and center speaker are installed
  -  Atmos 4.0/4.1: When front speakers and surround speakers are installed
  -  Atmos 5.0/5.1: When front speakers, center speaker and surround speakers are installed
  -  Atmos 2.0.2/2.1.2: When front speakers and height speakers are installed
  -  Atmos 3.0.2/3.1.2: When front speakers, center speaker and height speakers are installed
- To enable transfer of this audio format, connect via an HDMI cable and set the audio output on the player to Bitstream output.
  - When "Speaker Virtualizer" ( → [p62](#) ) is set to "Off" (Default: On), modes other than  Atmos cannot be selected.

#### ■ DD (Dolby Audio - DD)

This mode faithfully reproduces the sound design recorded in the Dolby Digital audio format.

Dolby Digital is a multi-channel digital format developed by Dolby Laboratories, Inc. and is widely adopted for use in movie production. It is also a standard audio format for DVD-Video and Blu-ray Discs. It is possible to record a maximum of 5.1 channels on a DVD-Video or Blu-ray Disc; two front channels, one center channel, two surround channels, and the LFE channel dedicated to the bass region (sound elements for the subwoofer).

- To enable transfer of this audio format, connect via a digital cable and set the audio output on the player to Bitstream output.

#### ■ DD+ (Dolby Audio - DD+)

This mode faithfully reproduces the sound design recorded in the Dolby Digital Plus audio format.

The Dolby Digital Plus format has been improved based on Dolby Digital, increasing the number of channels and endeavoring to improve sound quality by giving more flexibility in data bit rates. Dolby Digital Plus is an optional audio format based on 5.1 ch for Blu-ray Discs. It is possible to record a maximum of 7.1 channels with additional channels such as the surround back channel.

- To enable transfer of this audio format, connect via an HDMI cable and set the audio output on the player to Bitstream output.



## ■ Direct

This listening mode can be selected for all input signals. Processing that affects sound quality is shut down, and sound closer to the original is reproduced. The sound is reproduced with the sound field based on the number of channels in the input signal. For example, a 2 ch signal is output only from the front speakers.

Note that the sound adjustment is not available when this mode is selected.

## ■ Dolby Surr (Dolby Audio - Surr)

This listening mode expands 2 ch input signals to 5.1 ch. This mode expands actual channels to more channels for playback according to the configuration of the connected speakers. Also, even if there is no speaker for expansion, for example when only front speakers are connected, audio of surround channel or height channel is virtually created for expansion playback.

According to the speaker layout, the following listening modes are displayed.

- [Dolby Surr 2.0/2.1](#): When only front speakers are installed
  - [Dolby Surr 3.0/3.1](#): When front speakers and center speaker are installed
  - [Dolby Surr 4.0/4.1](#): When front speakers and surround speakers are installed
  - [Dolby Surr 5.0/5.1](#): When front speakers, center speaker and surround speakers are installed
  - [Dolby Surr 2.0.2/2.1.2](#): When front speakers and height speakers are installed
  - [Dolby Surr 3.0.2/3.1.2](#): When front speakers, center speaker and height speakers are installed
- When "Speaker Virtualizer" (→[p62](#)) is set to "Off" (Default: On), modes other than Dolby Surr cannot be selected.

## ■ DTHD (Dolby Audio - TrueHD)

This mode faithfully reproduces the sound design recorded in the Dolby TrueHD audio format.

The Dolby TrueHD audio format is a "lossless" format expanded based on the lossless compression technology referred to as MLP, and it faithfully reproduces the master audio recorded in the studio. Dolby TrueHD is an optional audio format based on 5.1 ch for Blu-ray Discs. It is possible to record a maximum of 7.1 channels with additional channels such as the surround back channel. 7.1 ch is recorded at 96 kHz/24 bit, and 5.1 ch is recorded at 192 kHz/24 bit.

- To enable transfer of this audio format, connect via an HDMI cable and set the audio output on the player to Bitstream output.

## ■ DSD

This mode is suitable for playing sources recorded in DSD.

- This unit supports the DSD signal input from the HDMI input terminal. However, depending on the connected player, better sound may be obtained by setting the output on the player side to the PCM output.
- This listening mode cannot be selected if the output setting on your Blu-ray Disc/DVD player is not set to DSD.

## ■ DTS

This mode faithfully reproduces the sound design recorded in the DTS audio format

The DTS audio format is a multi-channel digital format developed by DTS, Inc. This format is an optional audio format for DVD-Video and a standard format for Blu-ray Discs.

- To enable transfer of this audio format, connect via a digital cable and set the audio output on the player to Bitstream output.





## ■ DTS-HD

This mode faithfully reproduces the sound design recorded in the DTS-HD High Resolution Audio audio format or DTS-HD Master Audio.

These audio formats are optional audio format for Blu-ray Discs.

- To enable transfer of this audio format, connect via an HDMI cable and set the audio output on the player to Bitstream output.

## ■ DTS Neural:X

This listening mode expands actual channels to more channels for playback to suit the configuration of the connected speakers by expanding the input signals from 2 channels to 5.1 channels respectively.

## ■ DTS Virtual:X

DTS Virtual:X listening mode uses the proprietary audio processing technology to create spacious 3D sound including audio from up above without connecting height speakers.

This mode can be selected in any speaker layout such as front speakers-only connection. You can enjoy your favorite movies or TV programs with a more immersive audio experience.

- This mode cannot be selected when "Speaker Virtualizer" ( →[p62](#)) is set to "Off" (Default: On).

## ■ DTS:X

This mode faithfully reproduces the sound design recorded in the DTS:X audio format.

The DTS:X audio format is a combination of the mixing method based on traditional channel based formats (5.1 ch and 7.1 ch) and object based dynamic audio mixing, and it is characterized by the precise positioning of sounds and the ability to express sound movement.

- To enable transfer of this audio format, connect via an HDMI cable and set the audio output on the player to Bitstream output.

## ■ Mono

In this mode, monaural audio is played from the center speaker at the time of inputting an analog signal or PCM signal. If there is no center speaker connected, monaural audio is played from the front speakers.

## ■ Mono Music

In this mode, all speakers output the same sound in mono, so the sound you hear is the same regardless of where you are within the listening room.

## ■ Multich (Multichannel)

This mode is suitable to play sources recorded in multichannel PCM.

## ■ Orchestra

This mode is suitable for classical or operatic music. This mode emphasizes the surround channels in order to widen the sound image, and simulates the natural reverberation of a large hall.

## ■ Stereo

In this mode, sound is output from the right and left front speakers and subwoofer.

## ■ Studio-Mix

This mode is suitable for rock or pop music. This mode creates a lively sound field with a powerful acoustic image as if you are at a club or rock concert.

## ■ T-D (Theater-Dimensional)

In this mode, you can enjoy a virtual playback of multichannel surround sound even with only two or three speakers. This works by controlling how sounds reach the listener's left and right ears.

- This mode cannot be selected when "Speaker Virtualizer" ( →[p62](#)) is set to "Off" (Default: On).



## ■ TV Logic

Suitable for TV shows produced in a TV studio. This mode gives clarity to voices by enhancing the entire surround sounds, and creates a realistic acoustic image.

## ■ Unplugged

Suitable for acoustic instruments, vocals and jazz. This mode emphasizes the front sound field image, giving the impression of being in front of the stage.



# Speaker Combinations

• Up to two powered subwoofers can be connected in either combination.

Speaker Channels	FRONT	CENTER	SURROUND	HEIGHT
2.1 ch	✓			
3.1 ch	✓	✓		
4.1 ch	✓		✓	
5.1 ch	✓	✓	✓	
2.1.2 ch	✓			✓
3.1.2 ch	✓	✓		✓



## General Specifications

Amplifier Section	North American and Taiwanese models	European, Middle East, Australian and Asian models
Rated Output Power	<p><b>(North American models)</b> With 8 ohm loads, both channels driven, from 20 Hz-20 kHz; rated 80 watts per channel minimum RMS power, with no more than 0.08% total harmonic distortion from 250 milliwatts to rated output. (FTC)</p> <p><b>(Taiwanese models)</b> 5 ch × 135 W at 6 ohms, 1 kHz, 1 ch driven of 1% THD (IEC)</p>	5 ch × 135 W at 6 ohms, 1 kHz, 1 ch driven of 1% THD (IEC)
Maximum Effective Output Power	<p><b>(North American models)</b> 155 W at 6 ohms, 1 kHz, 1 ch driven of 10% THD</p> <p><b>(Taiwanese models)</b> 5 ch × 155 W at 6 ohms, 1 kHz, 1 ch driven of 10% THD (JEITA)</p>	<p><b>(European models)</b> 5 ch × 155 W at 6 ohms, 1 kHz, 1 ch driven of 10% THD (IEC)</p> <p><b>(Middle East, Australian and Asian models)</b> 5 ch × 155 W at 6 ohms, 1 kHz, 1 ch driven of 10% THD (JEITA)</p>
THD+N (Total Harmonic Distortion + Noise)	0.08% (20 Hz - 20,000 Hz, Rated output power)	
Input Sensitivity and Impedance	200 mV/32 kΩ (LINE(RCA))	
Rated RCA Output Level and Impedance	PRE OUT (SUBWOOFER) : 1 V/470 Ω	
	LINE OUT (ZONE B) : 1 V/200 mV/2.3 kΩ	
Frequency Response	10 Hz - 100 kHz/+1 dB, -3 dB (Direct)	
Tone Control Characteristics	±10 dB, 20 Hz (Bass), ±10 dB, 20 kHz (Treble)	
Signal to Noise Ratio	106 dB (IHF-A, LINE IN, SP OUT)	
Supported impedance of Speakers	4 Ω - 16 Ω	
Headphone Rated Output	80 mW + 80 mW (32 Ω, 1 kHz, 10% THD)	
Supported impedance of Headphones	8 Ω - 600 Ω	
Headphones Frequency Response	10 Hz - 100 kHz	



<b>Tuner Section</b>	<b>North American and Taiwanese models</b>	<b>European, Middle East, Australian and Asian models</b>
FM Tuning Frequency Range	87.5 MHz - 107.9 MHz	87.5 MHz - 108.0 MHz, RDS
50 dB quieting sensitivity (FM MONO)	2.8 $\mu$ V, 20.2 dBf (IHF, 1 kHz, 100% MOD)	
AM Tuning Frequency Range	530 kHz - 1710 kHz	<b>(Middle East, Australian and Asian models)</b> 522/530 kHz - 1611/1710 kHz
DAB Tuning Frequency Range	-	<b>(European models)</b> 174.928 MHz - 239.200 MHz (Band III)
DAB Sensitivity	-	<b>(European models)</b> -100 dBm (Min.) (Band III)
Preset Channel	40	

<b>BLUETOOTH Section</b>	<b>North American and Taiwanese models</b>	<b>European, Middle East, Australian and Asian models</b>
Communication system	BLUETOOTH Specification version 5.0	
Frequency band	2.4 GHz (2.402-2.480 GHz)	
Modulation method	FHSS (Frequency Hopping Spread Spectrum)	
Compatible BLUETOOTH profiles	A2DP v1.3, AVRCP v1.6, AVDTP v1.3, AVCTP v1.4	
Supported Codecs	SBC, AAC	
Transmission range (A2DP)	20 Hz - 20 kHz (Sampling frequency 44.1 kHz)	
Maximum communication range	Line of sight approx. 15 m(*) (*)The actual range will vary depending on factors such as obstacles between devices, magnetic fields around a microwave oven, static electricity, cordless phone, reception sensitivity, antenna's performance, operating system, software application, etc.	



HDMI	North American and Taiwanese models	European, Middle East, Australian and Asian models
Input	4	
Output	1	

	Input *1				Output
	HDMI 1	HDMI 2	HDMI 3	HDMI 4	
bandwidth	40Gbps	40Gbps	40Gbps	40Gbps	40Gbps
ALLM	✓	✓	✓	✓	✓
Gaming-VRR	✓	✓	✓	✓	✓
QFT	✓	✓	✓	✓	✓
SBTM	✓	✓	✓	✓	✓
DSC	✓	✓	✓	✓	✓
Uncompressed	8K/60p 4:2:0	8K/60p 4:2:0	8K/60p 4:2:0	8K/60p 4:2:0	8K/60p 4:2:0
Compressed (TV needs DSC)	8K/60p 4:4:4	8K/60p 4:4:4	8K/60p 4:4:4	8K/60p 4:4:4	8K/60p 4:4:4
ARC / eARC *2					✓
HDR10 / HLG (BT.2020)	✓	✓	✓	✓	✓
HDR10+	✓	✓	✓	✓	✓

\*1 Audio Format:

2 ch linear PCM (32 kHz, 44.1 kHz, 48 kHz, 88.2 kHz, 96 kHz, 176.4 kHz, 192 kHz, 16/20/24 bit)  
 Multi-channel linear PCM (Maximum 7.1 channels, 32 kHz, 44.1 kHz, 48 kHz, 88.2 kHz, 96 kHz, 176.4 kHz, 192 kHz, 16/20/24 bit)  
 Bitstream (Dolby Digital, Dolby Digital Plus, Dolby TrueHD, Dolby Atmos, DTS, DTS-ES, DTS 96/24, DTS-HD Master Audio, DTS-HD High Resolution Audio, DTS Express, DTS:X, IMAX DTS, IMAX DTS:X, DSD(2.8 MHz), PCM)

\*2 ARC compatible audio formats: PCM, Dolby Digital, Dolby Digital Plus, DTS (DTS 96/24, DTS-ES, etc.), DTS-HD High Resolution Audio, IMAX DTS

eARC compatible audio formats: PCM, Dolby Digital, Dolby Digital Plus, DTS (DTS 96/24, DTS-ES, etc.), Dolby TrueHD, Dolby Atmos, DTS- HD Master Audio, DTS:X, Multichannel PCM, DTS-HD High Resolution Audio, IMAX DTS, IMAX DTS:X



Corresponding input resolutions	Frame rate	Color space	Color depth	HDMI IN 1 - 4	
4K (3840x2160p)	24/25/30 Hz	YCbCr4:2:2	12 bit	✓	
		YCbCr4:4:4/RGB	8 bit	✓	
			10/12 bit	✓	
	48/50/60 Hz	YCbCr4:2:0	8 bit	✓	
			10/12 bit	✓	
			YCbCr4:2:2	12 bit	✓
		YCbCr4:4:4/RGB	8 bit	✓	
			10/12 bit	✓	
			12 bit	✓(*1)	
100/120 Hz	YCbCr4:2:0	8/10/12 bit	✓		
	YCbCr4:2:2	12 bit	✓		
	YCbCr4:4:4/RGB	8/10 bit	✓		
5K (5120x2160p)	24/25/30 Hz	YCbCr4:2:2	12 bit	✓	
		YCbCr4:4:4/RGB	8 bit	✓	
			10/12 bit	✓	
	48/50/60 Hz	YCbCr4:2:0	8/10/12 bit	✓(*2)	
		YCbCr4:2:2	12 bit	✓	
		YCbCr4:4:4/RGB	8 bit	✓	
			10/12 bit	✓	
			12 bit	✓	
		8K (7680x4320p)	24/25/30 Hz	YCbCr4:2:0	8/10/12 bit
YCbCr4:2:2	12 bit			✓	
YCbCr4:4:4/RGB	8/10 bit			✓	
48/50/60 Hz	YCbCr4:2:0		8/10 bit	✓	
			12 bit	✓(*1)	
			12 bit	✓(*1)	
	YCbCr4:2:2		12 bit	✓(*1)	
			YCbCr4:4:4/RGB	8/10/12 bit	✓(*1)
				8/10 bit	✓(*1)

(\*1) Video compressed with DSC (Display Stream Compression) can be input and output. DSC is a video compression technique that enables the transmission of high-resolution video, which requires high bandwidth, via HDMI. While playing this video format, there is no on-screen display when you perform such operations as using the Quick Menu or adjusting the volume.

(\*2) 5K, 48 Hz, YCbCr4:2:0, 8/10/12 bit is not supported.

- Signals are output from the HDMI OUT jack of this unit to the TV with the same resolution as the input resolution. When a TV supporting 4K is used, HDMI video signals with 1080p can be output with 4K.



USB Section	North American and Taiwanese models	European, Middle East, Australian and Asian models
USB	1 (Only for supplying power to Streaming media player, 5 V/1.0 A)	

General	North American and Taiwanese models	European, Middle East, Australian and Asian models
Power Supply	AC 120 V, 60 Hz	AC 220 - 240 V, 50/60 Hz
Power Consumption	445 W	465 W
Full Standby mode	0.2 W	0.3 W
HDMI CEC Standby	0.2 W	0.3 W
Dimensions (W × H × D)	435 mm × 160 mm × 328 mm 17-1/8" × 6-5/16" × 12-15/16"	
Weight	8.2 kg (18.1 lbs.)	8.4 kg (18.5 lbs.)
Maximum radio-frequency power transmitted in the frequency band(s)	-	<b>(European models)</b> 2402 MHz - 2480 MHz (4 dBm (e.i.r.p))

Audio Inputs	North American and Taiwanese models	European, Middle East, Australian and Asian models
Analog	3 (RCA×3)	
Digital	2 (COAXIAL×1, OPTICAL×1) • Supported sampling rates for PCM signals (stereo, mono) from a digital input are 32 kHz, 44.1 kHz, 48 kHz, 88.2 kHz, 96 kHz/16 bit, 20 bit, and 24 bit.	





Audio Outputs	North American and Taiwanese models	European, Middle East, Australian and Asian models
Analog	ZONE B LINE OUT, SUBWOOFER PRE OUT ×2	
Speaker Outputs	FRONT L/R, CENTER, SURROUND L/R or HEIGHT L/R (North American and Taiwanese models support banana plugs)	
Phones	1 (ø 6.3 mm, 1/4")	

Others	North American and Taiwanese models	European, Middle East, Australian and Asian models
Setup Mic	1 (Front)	

Specifications and features are subject to change without notice.

 → [License and Trademark](#)



**ONKYO**

SN 29404112\_EN

© Copyright 2023 Onkyo Technology, K.K. All rights reserved. ©2023 Onkyo Technology, K.K. Tous droits de reproduction et de traduction réservés.

F2307-0